

VERSALLES



IP65



Our PROFESSIONAL led profile series for surfaces is manufactured in high purity aluminium and available in anodised silver, black and white lacquered. This profile is ideal for using on wall surfaces, furniture, shelves and similar areas, where a width greater than the standard is required. This allows us to use wider led strips for an increased heat dissipation and a wider angle of light emission.

By providing a lower channel for the return path of the cable, the profile allows us to close the circuit therefore steep voltage drops are prevented. Small drivers can also be placed in this lower channel.

Its cover (available in 7 different finishings), which offers our “easy-ON” system, once combined with this profile provides an IP65 rating to the luminaire. It can be used in places with high levels of humidity, such as bathrooms, kitchens, gyms, spas, cold storage chambers, fridges, or others.

The profile and its covers are available in lengths of 2 and 6 metre, thus allowing us to carry out large projects, where all the profiles do not require joints or similar surface breaks. It is suitable for led strips with a maximum width of 15mm, whose power level does not exceed 35W/m. In order to obtain a more homogeneous and diffused illumination, we recommend the combined use of both our opal covers and Canovelles-Barcelona-Gomera-COB ecoled strips.

We offer a 10 year guarantee on the profiles and a 4 year guarantee on the covers.

Scale 1:1

By applying the lens cover on the Versalles profile together with the flexible led strip we get a beam of 60° light.

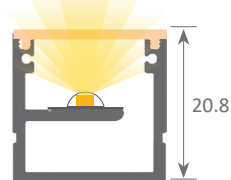

simple cover

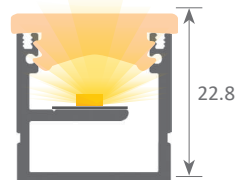

Flex&Cover Arles
See page 170

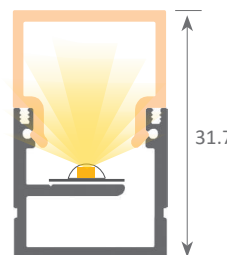

square cover

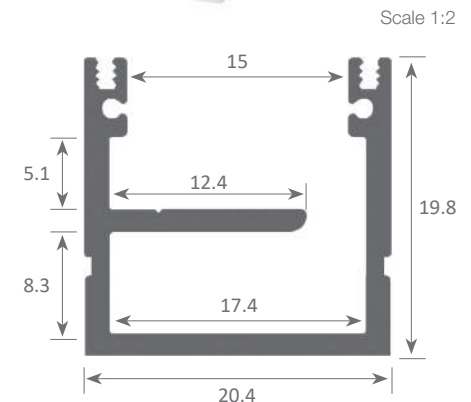

Scale 1:2

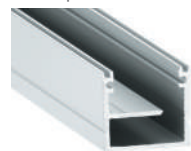

Aluminium profile

02.018	anodised silver	2m
02.019	anodised black	2m
02.036	white lacquered*	2m
02.020	anodised silver	6m
02.021	anodised black	6m
02.033	white lacquered*	6m



Plastic endcaps

19.034	grey without hole
19.293	black without hole
19.429	white without hole



Endcaps for square cover

19.035	without hole (white)
19.036	without hole (black)



Clip

20.009	stainless steel
20.010	black oxide finish

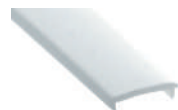

Polycarbonate cover “easy-ON”

18.022	transparent	2m
18.023	opal	2m
18.024	frosted	2m
18.025	transparent	6m
18.026	opal	6m
18.027	frosted	6m
18.170	frosted	60m

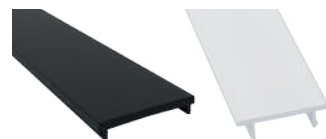

Black&White cover “easy-ON”

18.028	Black&White	2m
18.029	Black&White	6m

Polycarbonate cover

18.127	frosted	2m
18.126	frosted	6m

*Compatible with XL profiles in white

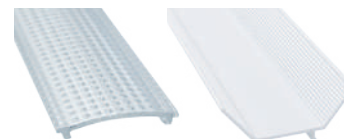

Polycarbonate cover “easy-ON”

18.130	microprism	2m
18.129	microprism	6m

Polycarbonate cover with side wings

18.132	frosted	2m
18.131	frosted	6m



Square cover

18.032	frosted	2m
18.102	Black&White	2m
18.033	frosted	6m
18.034	Black&White	6m

Methacrylate UV cover “easy-ON”

18.181	frosted	2m
18.180	frosted	6m

* This profile in white lacquered is not compatible with the easy-ON cover.



Patente Europea
Nº.: 13156605.1

Aluminium alloy extrusion process in accordance with: ISO 9001:2008 - ISO 14001 / Tolerances defined by: UNE-EN 755-9 / UNE-EN 12020-2
Theoretical weight: 0.273kg / Alloy: 6063 / Perimeter: 159mm / Anodising minimum: 15 microns
Aluminium purity: 95-98% / Material treatment: T-5 / Covers: Fireproof V0

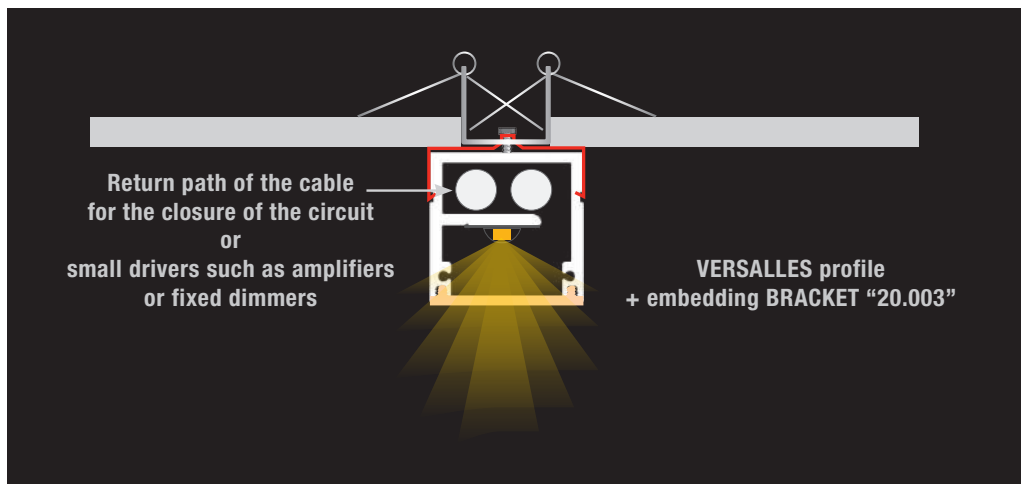

Embedding clip

20.003 chrome steel
(clip not included)



Adjustable bracket

20.004 chrome steel
(clip not included)



Hanging KIT

21.001 chrome set of 2 units
21.002 white set of 2 units
21.003 black set of 2 units
(clip not included)