

# led profile

- Led profiles for surfaces 42
- Led profiles for recessing 68
- Angular led profiles 80
- Circular led profiles 92
- Led profiles for stairs and skirting boards 104
- Architectural led profiles 122
- Led profiles for walls 134
- Led profiles for shelving and signage 150
- Flexible led profiles 162
- Silicone led profiles (neon) 174
- Big profiles for surfaces and hanging 190
- Big profiles for recessing 212
- Luminous textile (Shinka) 228
- Special led profiles on request 232
- Sample display cases 240

# Index for led profile (newly added items)

STOCK IN FACTORY  
 ■ HIGH ■ MODERATE ■ ON DEMAND  
 SILVER ANODISED ■ BLACK ANODISED □ WHITE LACQUERED

## Angular led profiles



AMSTERDAM  
MINI

"easy-ON" IP65	x
Maximum length (m)	1
Stock in factory	■
Dimensions (L-H)	11.8x13.4
Guarantee (years)	2
Colours	■ □
PAGE	91A

## Led profiles for walls

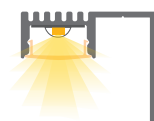

TALLIN

"easy-ON" IP65	x
Maximum length (m)	3
Stock in factory	■
Dimensions (L-H)	50x29.4
Guarantee (years)	2
Colours	□
PAGE	149A

## Led profiles for signage



BONN

"easy-ON" IP65	x
Maximum length (m)	1
Stock in factory	■
Dimensions (L-H)	22x133.5
Guarantee (years)	5
Colours	■
PAGE	161A

## Circular hanging led profiles



VIENA

"easy-ON" IP65	x
Maximum length (m)	2
Stock in factory	■
Dimensions (L-H)	27x45
Guarantee (years)	5
Colours	■ □
PAGE	103A



OSLO MINI

"easy-ON" IP65	x
Maximum length (m)	3
Stock in factory	■
Dimensions (L-H)	25x25
Guarantee (years)	2
Colours	□
PAGE	103B



OSLO DOBLE

"easy-ON" IP65	x
Maximum length (m)	3
Stock in factory	■
Dimensions (L-H)	31x29
Guarantee (years)	2
Colours	■
PAGE	103C

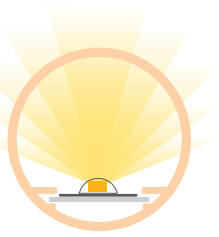

OSLO 40

"easy-ON" IP65	x
Maximum length (m)	3
Stock in factory	■
Dimensions (L-H)	40x40
Guarantee (years)	2
Colours	■
PAGE	103D

## Silicone led profiles



NEÓN EASY

"easy-ON" IP65	x
Maximum length (m)	50
Stock in factory	■
Dimensions (L-H)	16x20
Guarantee (years)	2
Colours	□
PAGE	186A

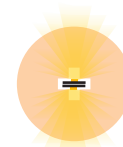

NEÓN 360°

"easy-ON" IP65	x
Maximum length (m)	5
Stock in factory	■
Dimensions (L-H)	25x25
Guarantee (years)	2
Colours	□
PAGE	186B



NEÓN SLIM

"easy-ON" IP65	x
Maximum length (m)	50
Stock in factory	■
Dimensions (L-H)	5x13
Guarantee (years)	2
Colours	□
PAGE	186D



NEÓN CUADRADO XL

"easy-ON" IP65	x
Maximum length (m)	100
Stock in factory	■
Dimensions (L-H)	12x12
Guarantee (years)	2
Colours	□
PAGE	186E



NEÓN LAS VEGAS EASY

"easy-ON" IP65	x
Maximum length (m)	100
Stock in factory	■
Dimensions (L-H)	23x12
Guarantee (years)	2
Colours	□
PAGE	186F

# Index for led profile (newly added items)

**STOCK IN FACTORY**  
 ■ HIGH ■ MODERATE ■ ON DEMAND  
 ■ SILVER ANODISED ■ BLACK ANODISED □ WHITE LACQUERED

## Big profiles for hanging and surfaces

	KRAKOVIA WITH REFLECTOR AND OPTIC	LOLA	RICARDO	PACO	ANTONIO	CARMEN	KAZÁN
"easy-ON" IP65	x	x	x	√	√	√	x
Maximum length. (m)	3.4	6	6	6	6	6	6
Stock in factory	■	■	■	■	■	■	■
Dimensions (L-H)	58x68	87x39.9	87.7x43.1	90x100	90x90	110x90	125x39
Guarantee (years)	2	10	10	10	10	10	2
Colours	■ □	■ ■ ■ ■ ■ ■ ■ ■	■ ■ ■ ■ ■ ■ ■ ■	■ ■ ■ ■ ■ ■ ■ ■	■ ■ ■ ■ ■ ■ ■ ■	■ ■ ■ ■ ■ ■ ■ ■	■ ■ ■ ■ ■ ■ ■ ■
<b>PAGE</b>	<b>211A</b>	<b>211E</b>	<b>211G</b>	<b>211I</b>	<b>211K</b>	<b>211M</b>	<b>211C</b>







## Big profiles for embedding

	GALES WITH REFLECTOR AND OPTIC	KIEV	SIDNEY
"easy-ON" IP65	x	√	x
Maximum length (m)	2	6	2,5
Stock in factory	■	■	■
Dimensions (L-H)	77x68	45x56.5	13x45
Guarantee (years)	2	10	2
Colours	■ □	■ □	■ □
<b>PAGE</b>	<b>227A</b>	<b>227C</b>	<b>227E</b>

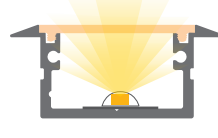

# Index for led profile applications

STOCK IN FACTORY  
 ■ HIGH ■ MODERATE ■ ON DEMAND  
 ■ SILVER ANODISED ■ BLACK ANODISED □ WHITE LACQUERED

## Profiles for embedding

							
	PHILADELPHIA MINI	FRANKFURT	BOSTON	BERLIN	BERLIN XL	PHILADELPHIA	DALLAS
"easy-ON" IP65	x	✓	x	✓	✓	x	x
Maximum length (m)	3	6	6	6	6	6	2
Stock in factory	■	■	■	■	■	■	■
Dimensions (L-H)	12X11.95	20.7x7.5	23x8	24x12	28.4x12.5	23x14.5	12.5x17
Guarantee (years)	2	10	2	10	10	2	2
Colours	■ ■	■ ■ □	■ □	■ ■ □	■ ■ □	■ □	■
PAGE	78	71	70	73	74	72	76

## Angular profiles

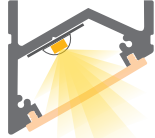







								
	TEXAS MINI	AMSTERDAM	SPLIT	ZAGREB	TEXAS	SOPHIA	SOPHIA XL	SOPHIA XL ASYMMETRIC
"easy-ON" IP65	x	x	x	x	x	✓	✓	✓
Maximum length (m)	2	3	3	3	6	6	6	6
Stock in factory	■	■	■	■	■	■	■	■
Dimensions (L-H)	10x10	30x14.4	16x16	16x16	18.5x18.5	19.31x19.31	22.5x22.5	20.40x20.67
Guarantee (years)	2	2	2	2	2	10	10	10
Colours	■	■	■	■	■ □	■ ■ □	■ ■ □	■ ■
PAGE	88	86	91	90	82	83	84	87

# Index for led profile applications

**STOCK IN FACTORY**  
 ■ HIGH ■ MODERATE ■ ON DEMAND  
 ■ SILVER ANODISED ■ BLACK ANODISED □ WHITE LACQUERED

## Surface profiles

										
	DETROIT	NEW YORK MINI	HARMONY XS	HARMONY	TENNESSEE	MILANO SLIM	MILANO	CALIFORNIA	CALIFORNIA XL	TORINO
"easy-ON" IP65	x	x	x	x	x	√	√	x	x	x
Maximum length (m)	2	3	3	3	2	6	6	6	3	6
Stock in factory	■	■	■	■	■	■	■	■	■	■
Dimensions (L-H)	8x7.7	7.6x9	11x4.5	18x5.7	12x8	16x4.05	16x7	17x8	23.5x9.8	18x14
Guarantee (years)	2	2	2	2	2	10	10	2	2	2
Colours	■	■ ■	■ □	■ □	■	■ ■	■ ■ □	■ □	■	■
<b>PAGE</b>	<b>62</b>	<b>64</b>	<b>168</b>	<b>166</b>	<b>63</b>	<b>164</b>	<b>44</b>	<b>46</b>	<b>47</b>	<b>60</b>

									
	ROMA	ROMA XL	NEW YORK	VERSALLES	BERNA	INFERNO	CHICAGO	VISBY	MONTERREY
"easy-ON" IP65	√	√	x	√	x	√	x	x	x
Maximum length (m)	6	6	6	6	2	6	1	3	1,18
Stock in factory	■	■	■	■	■	■	■	■	■
Dimensions (L-H)	16x11	20.4x11.5	17x14.5	20.4x19.8	40x16	26.5x19.2	6.1x25	25x25	30x40
Guarantee (years)	10	10	2	10	2	10	2	2	2
Colours	■ ■ □	■ ■ □	■ □	■ ■	□	■ ■	■	□	□
<b>PAGE</b>	<b>48</b>	<b>52</b>	<b>50</b>	<b>54</b>	<b>65</b>	<b>56</b>	<b>58</b>	<b>66</b>	<b>67</b>

# Index for led profile applications

STOCK IN FACTORY  
 ■ HIGH ■ MODERATE ■ ON DEMAND  
 ■ SILVER ANODISED ■ BLACK LACQUERED □ WHITE LACQUERED

## Architectural led profiles

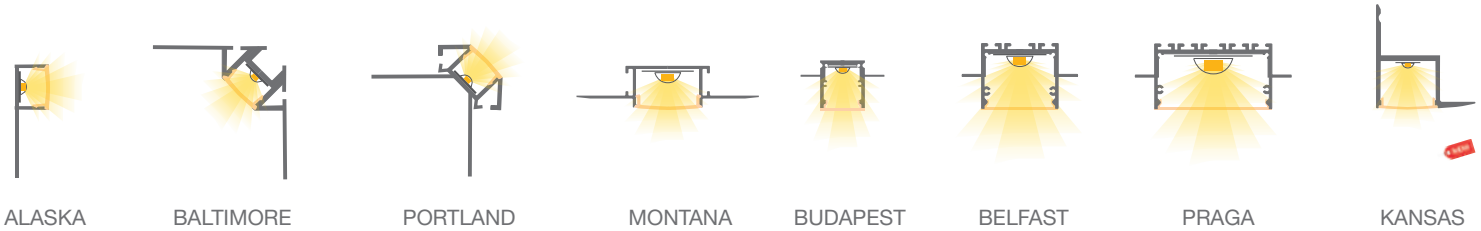

	ALASKA	BALTIMORE	PORTLAND	MONTANA	BUDAPEST	BELFAST	PRAGA	KANSAS
"easy-ON" IP65	x	x	x	x	x	x	x	x
Maximum length (m)	3	3	3	2	2	2	2	2
Stock in factory	■	■	■	■	■	■	■	■
Dimensions (L-H)	36x11.3	60.6x26.4	45.1x30.3	61.5x14	34.4x19.7	47.4x26.6	64x26.6	45x46.7
Guarantee (years)	2	2	2	2	2	2	2	2
Colours	■	■	■	■	□	□	□	■
PAGE	131	133	132	130	128	127	126	129

## Led profiles for walls

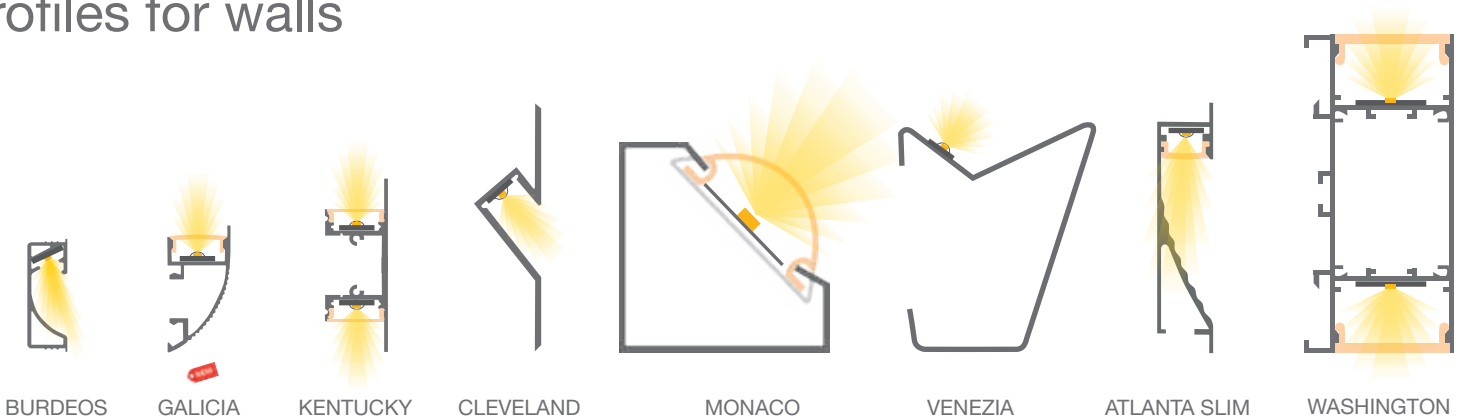

	BURDEOS	GALICIA	KENTUCKY	CLEVELAND	MONACO	VENEZIA	ATLANTA SLIM	WASHINGTON
"easy-ON" IP65	x	x	x	x	x	x	x	x
Maximum length (m)	2.6	3	3	3	2	2	3	3
Stock in factory	■	■	■	■	■	■	■	■
Dimensions (L-H)	11.3x32	18x32.5	17.3x49.5	19.4x70.2	55x55	56x65	15.8x71	42.3x90
Guarantee (years)	2	2	2	2	2	2	2	2
Colours	□	■	■	■	□	□	■	■
PAGE	140	144	136	138	143	142	141	137

# Index for led profile applications

**STOCK IN FACTORY**  
 ■ HIGH ■ MODERATE ■ ON DEMAND  
 ■ SILVER ANODISED ■ BLACK LACQUERED □ WHITE LACQUERED

## Led profiles for stairs and skirting boards

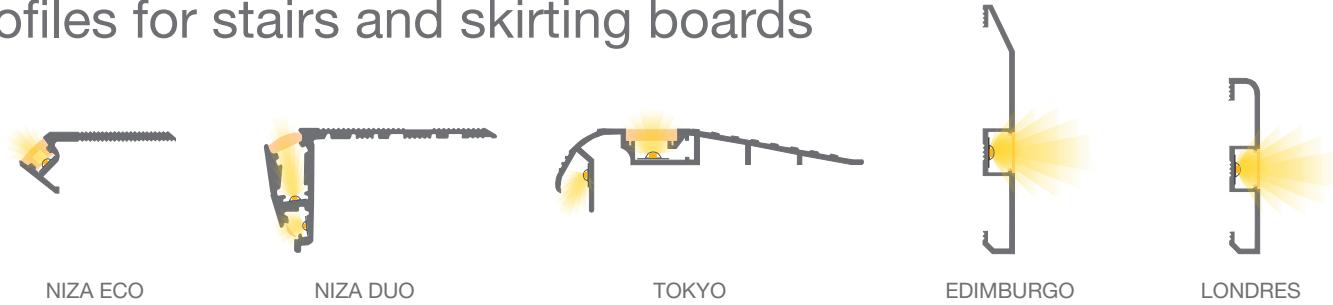

	NIZA ECO	NIZA DUO	TOKYO	EDIMBURGO	LONDRES
"easy-ON" IP65	x	x	√	x	x
Maximum length (m)	2.4	2.4	6	2	2
Stock in factory	■	■	■	■	■
Dimensions (L-H)	53.5x20.5	80x42.5	105.6x28.7	10.2x80	10.2x58
Guarantee (years)	2	2	10	2	2
Colours	■	■	■ ■	□	□
<b>PAGE</b>	<b>114</b>	<b>115</b>	<b>116</b>	<b>110</b>	<b>111</b>

## Led profiles for floors

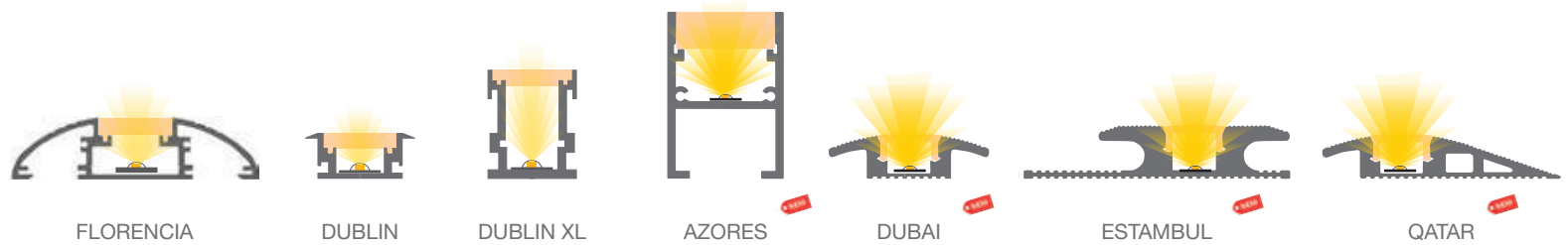

	FLORENCIA	DUBLIN	DUBLIN XL	AZORES	DUBAI	ESTAMBUL	QATAR
"easy-ON" IP65	√	√	√	x	x	x	x
Maximum length (m)	6	6	3	2	3	3	3
Stock in factory	■	■	■	■	■	■	■
Dimensions (L-H)	59.5x14.8	26.6x11	21.3x26.1	28x40	38.1x10.8	63.5x12.7	57.1x10.8
Guarantee (years)	10	10	10	2	2	2	2
Colours	■	■	■	■	■	■	■
<b>PAGE</b>	<b>112</b>	<b>107</b>	<b>108</b>	<b>106</b>	<b>119</b>	<b>118</b>	<b>120</b>

# Index for led profile applications

STOCK IN FACTORY  
 ■ HIGH ■ MODERATE ■ ON DEMAND  
 ■ SILVER ANODISED ■ BLACK ANODISED □ WHITE LACQUERED

## Circular hanging led profiles

## Led profiles for signage

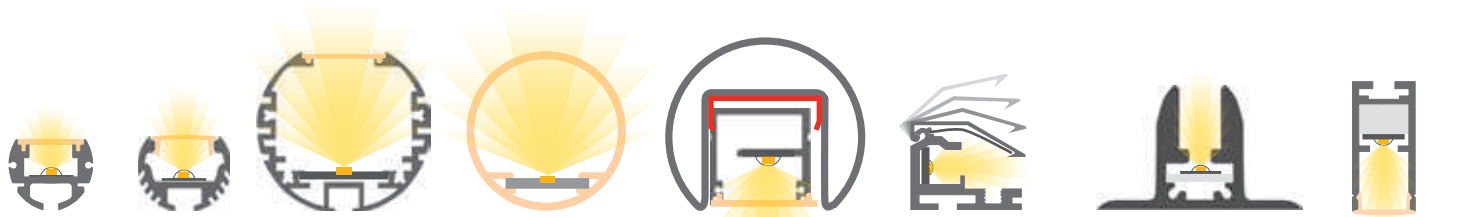

	PARIS	MIAMI	PARIS XL	OSLO OSLO BLACK&WHITE	COMENZA	ALFA 2	GINEBRA	HANNOVER
"easy-ON" IP65	√	x	√	x	x	x	x	x
Maximum length (m)	6	6	6	3	5	6	3	6
Stock in factory	■	■	■	■	■	■	■	■
Dimensions (L-H)	19x15.32	20.5x16.7	39x35.79	Ø38	Ø42.4	28.9x21.5	50x30	15x30.8
Guarantee (years)	10	2	10	2	2	10	10	10
Colours	■ ■	■ □	■ ■ □	frosted/B&W	stainless steel	■	■	■
PAGE	94	98	100	103 - 102	146	160	154	152

## Led profiles for shelvings and others



	PLETINA	A03	MONTECARLO	COLONIA	PLEXILED SLIM	PLEXILED
"easy-ON" IP65	x	x	x	x	x	x
Maximum length (m)	1	6	6	3	3	6
Stock in factory	■	■	■	■	■	■
Dimensions (L-H)	15x3	15x20	13.3x25	40x14	40x7	76x10
Guarantee (years)	2	2	10	10	2	2
Colours	■	■ □ ■	■	■	■	■
PAGE	159	158	161	155	156	157



# Index for led profile applications

**STOCK IN FACTORY**  
 ■ HIGH ■ MODERATE ■ ON DEMAND  
 □ WHITE OPAL

## Silicone led profiles

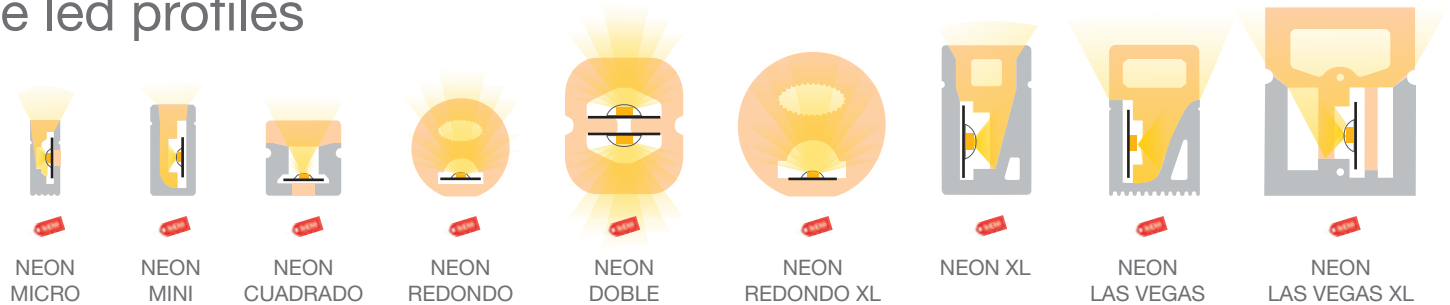

"easy-ON" IP65	x	x	x	x	x	x	x	x	x
Maximum length (m)	100	100	100	100	25	50	100	100	40
Stock in factory	■	■	■	■	■	■	■	■	■
Dimensions (L-H)	4x10	6x12	10x10	Ø13	15.6x18	Ø20	12x20	12x20	20x25
Guarantee (years)	2	2	2	2	2	2	2	2	2
Colours	□	□	□	□	□	□	□	□	□
<b>PAGE</b>	<b>176</b>	<b>177</b>	<b>178</b>	<b>180</b>	<b>182</b>	<b>181</b>	<b>183</b>	<b>184</b>	<b>185</b>

## Flexible led profiles

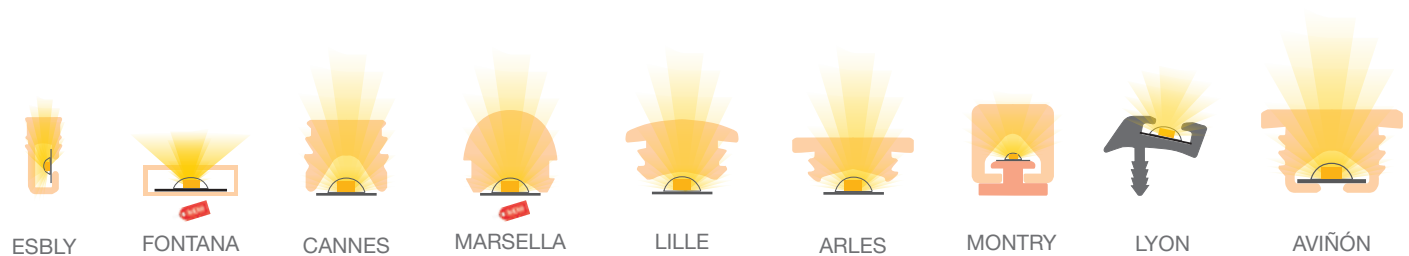

"easy-ON" IP65	x	x	x	x	x	x	x	x	x
Maximum length (m)	40	200	50	10	50	40	20	1	25
Stock in factory	■	■	■	■	■	■	■	■	■
Dimensions (L-H)	7x15	12.5x4	10x9.5	12x10	13x6.7	21.8x8.4	16.6x15.5	16x16.5	21.1x13
Guarantee (years)	2	2	2	2	2	2	2	2	2
Colours	□	transparent	□	8 colours	□	□	□	■	□
<b>PAGE</b>	<b>170</b>	<b>186</b>	<b>170</b>	<b>170</b>	<b>170</b>	<b>170</b>	<b>170</b>	<b>172</b>	<b>170</b>

# Index for led profile applications

**STOCK IN FACTORY**  
 ■ HIGH ■ MODERATE ■ ON DEMAND  
 ■ SILVER ANODISED ■ BLACK LACQUERED □ WHITE LACQUERED

## Big profiles for embedding

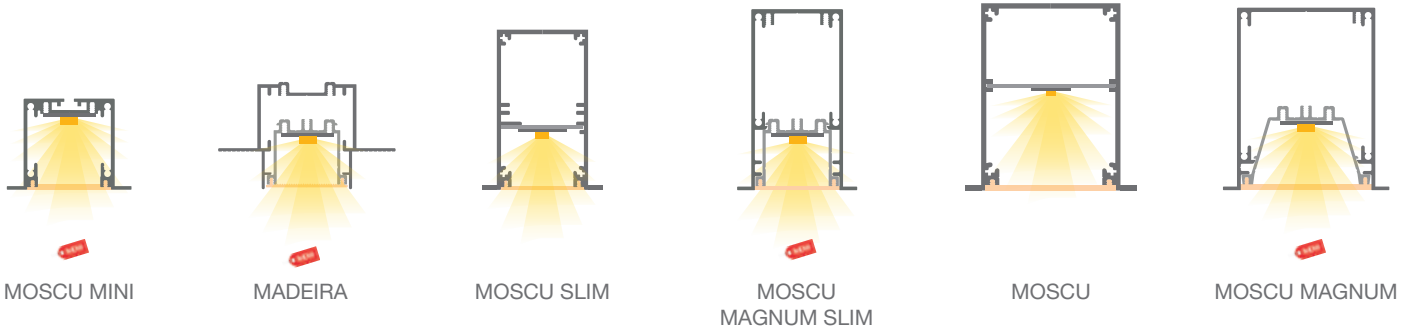

	MOSCU MINI	MADEIRA	MOSCU SLIM	MOSCU MAGNUM SLIM	MOSCU	MOSCU MAGNUM
"easy-ON" IP65	✓	✓	✓	✓	✓	✓
Maximum length (m)	6	6	6	6	6	6
Stock in factory	■	■	■	■	■	■
Dimensions (L-H)	52x38	73.85x44.65	50x66.7	52x75	72x78	72x76
Guarantee (years)	10	10	10	10	10	10
Colours	■ □ ■	■	■ □ ■	■ □ ■	■ □ ■	■ □ ■
<b>PAGE</b>	<b>214</b>	<b>124</b>	<b>220</b>	<b>216</b>	<b>221</b>	<b>218</b>

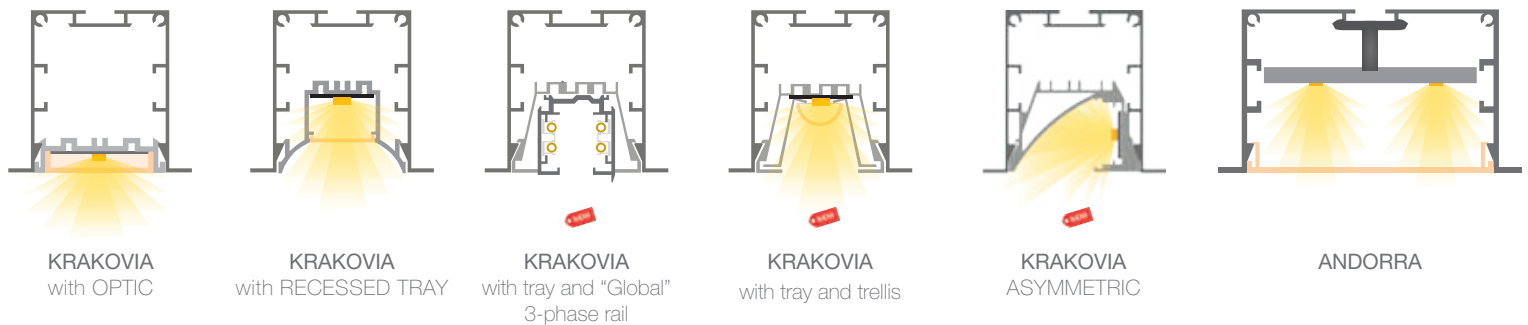

	KRAKOVIA with OPTIC	KRAKOVIA with RECESSED TRAY	KRAKOVIA with tray and "Global" 3-phase rail	KRAKOVIA with tray and trellis	KRAKOVIA ASYMMETRIC	ANDORRA
"easy-ON" IP65	x	x	x	x	x	x
Maximum length (m)	3.4	3.4	3.4	3.4	3.4	3.4
Stock in factory	■	■	■	■	■	■
Dimensions (L-H)	77x68	77x68	77x68	77x68	77x68	126x68
Guarantee (years)	2	2	2	2	2	2
Colours	■ □ ■	■ □ ■	■ □ ■	■ □ ■	■ □ ■	■ □
<b>PAGE</b>	<b>222</b>	<b>223</b>	<b>224</b>	<b>225</b>	<b>226</b>	<b>227</b>

# Index for led profile applications

**STOCK IN FACTORY**  
■ HIGH ■ MODERATE ■ ON DEMAND  
■ SILVER ANODISED ■ BLACK LACQUERED  WHITE LACQUERED

## Big profiles for hanging and surfaces

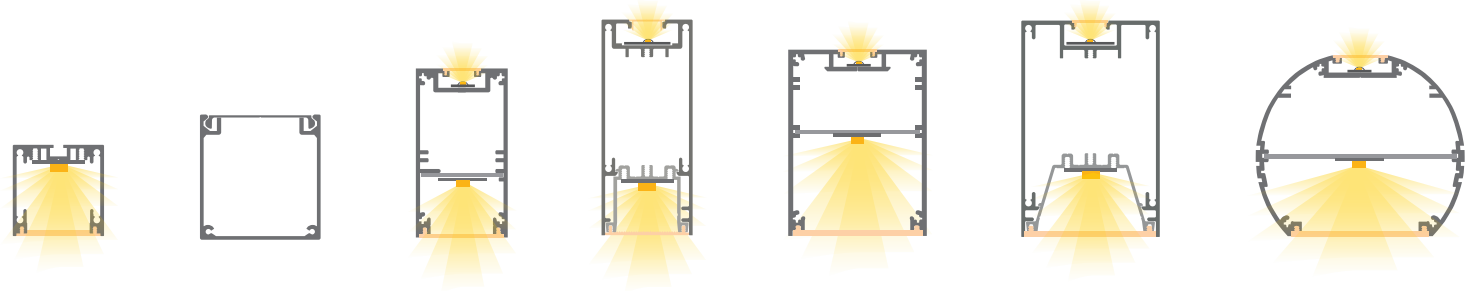

MUNICH MINI      BOX      MUNICH SLIM      MUNICH MAGNUM SLIM      MUNICH      MUNICH MAGNUM      SICILIA

"easy-ON" IP65	✓	x	✓	✓	✓	✓	✓
Maximum length (m)	6	4	6	6	6	6	6
Stock in factory	■	■	■	■	■	■	■
Dimensions (L-H)	38x38	50x52	38x70.1	38x90	58x78	57.6x90	87x75.31
Guarantee (years)	10	2	10	10	10	10	10
Colours	■ □ ■	■	■ □ ■	■ □ ■	■ □ ■	■ □ ■	■
<b>PAGE</b>	<b>192</b>	<b>202</b>	<b>198</b>	<b>194</b>	<b>200</b>	<b>196</b>	<b>208</b>

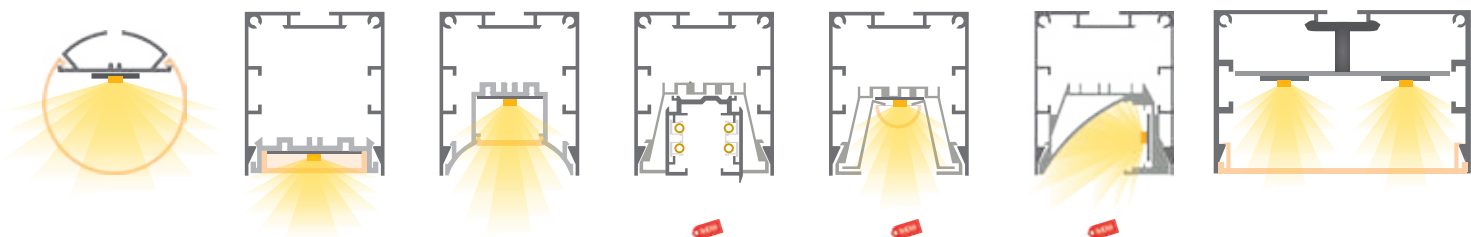

HOUSTON      GALES with OPTIC      GALES with RECESSED TRAY      GALES with tray and "Global" 3-phase rail      GALES with tray and trellis      GALES ASYMMETRIC      BRUSELAS

"easy-ON" IP65	x	x	x	x	x	x	x
Maximum length (m)	3	3.4	3.4	3.4	3.4	3.4	3.4
Stock in factory	■	■	■	■	■	■	■
Dimensions (L-H)	Ø60	58x68	58x68	58x68	58x68	58x68	107x68
Guarantee (years)	2	2	2	2	2	2	2
Colours	■	■ □ ■	■ □ ■	■ □ ■	■ □ ■	■ □ ■	■ □
<b>PAGE</b>	<b>210</b>	<b>203</b>	<b>206</b>	<b>204</b>	<b>205</b>	<b>207</b>	<b>211</b>

# Profiles; manufacturing

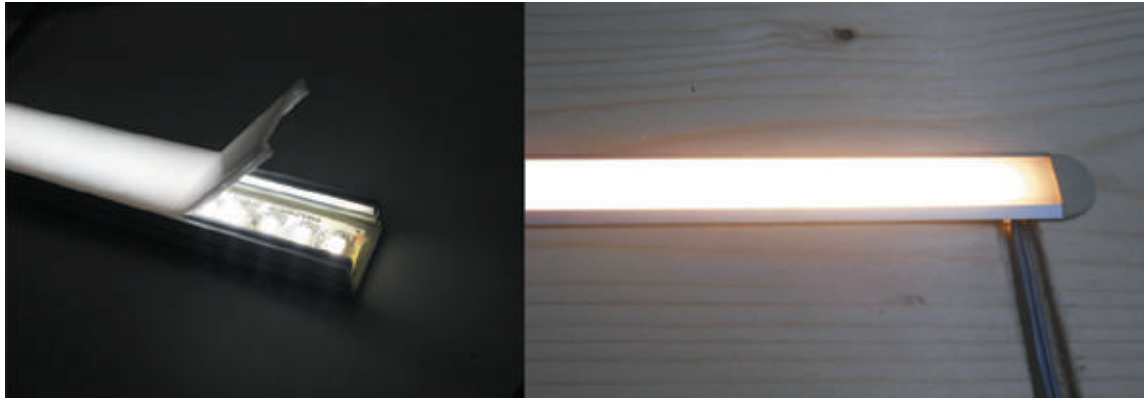

The vast majority of the profiles featured in this catalogue have been thought out and designed by Luz Negra and manufactured in Spain.

We have used excellent raw materials and manufacturing has been carried out under the most meticulous and strictest quality standards not only for profiles, but also for covers, lacquered, anodised, etc.

## Aluminium profile “easy-ON” (10 year guarantee) – Italian manufacturing moulding with a minimum tolerance

Our profiles have been manufactured according to ISO 9001:2008 - ISO 14001, with tolerances stipulated in standards UNE-EN 755-9 - UNE-EN 12020-2. The alloying which is used is 6063, starting from an aluminium billet with a purity of between 95-98% and then applying a T5 treatment.



Aluminium billets



Profile matrix

The anodised material has a minimum of 15 microns and holds Qualanod certification and Qualicoat-Seaside (in the case of lacquered profiles).

Our profiles are anodised in the biggest and most advanced anodising plant in Europe, with production levels greater than 180000m<sup>2</sup> month.



Billet in the press



Profile extrusion process



Profile anodising process

# Finishes for led profile

## Anodised profiles

Since the profiles undergo a controlled oxidation process when being anodised, their resulting thickness will be thinned down to a lesser quantity of microns when compared to the values before the anodising.

By providing a 15 micron thick layer to the profile, we enhance its thermal stability to a greater degree, and so the anodised profile becomes more resistant to degradation over time than its raw version.

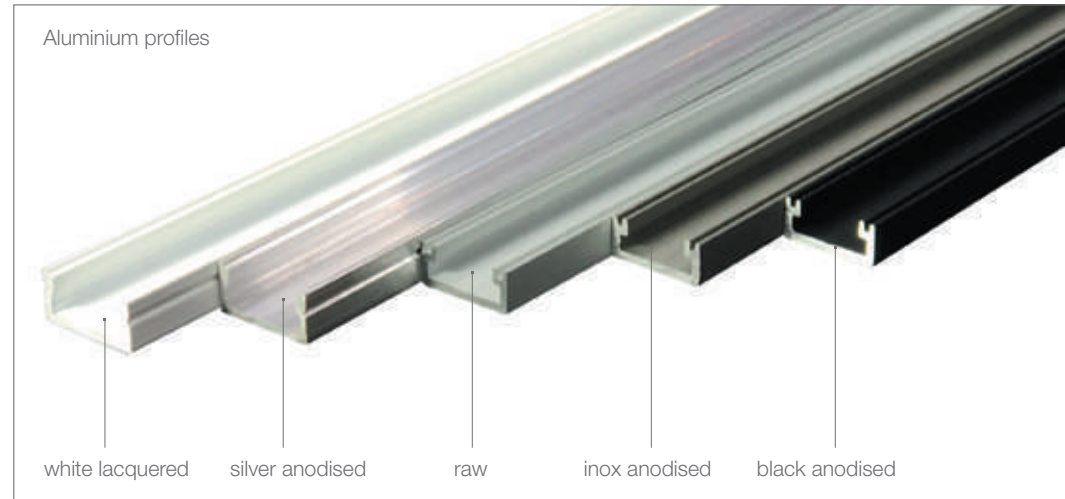

All our anodised items are  
QUALANOD certified



Special anodising can be carried out  
on demand, where the standard is  
normally silver / inox / black

## Lacquered profiles

We are applying a new textured and lacquered finish on the profiles, which not only gives a modern appearance but also makes them more resistant to impact and scratches.

All lacquering carried out on our profiles are preceded by a coating of chrome and are certified by Qualicoat, offering a lifetime guarantee for lacquering.

Please refer to our data sheets to check information regarding our covers and also for the lacquering/ anodising processes available for each profile.

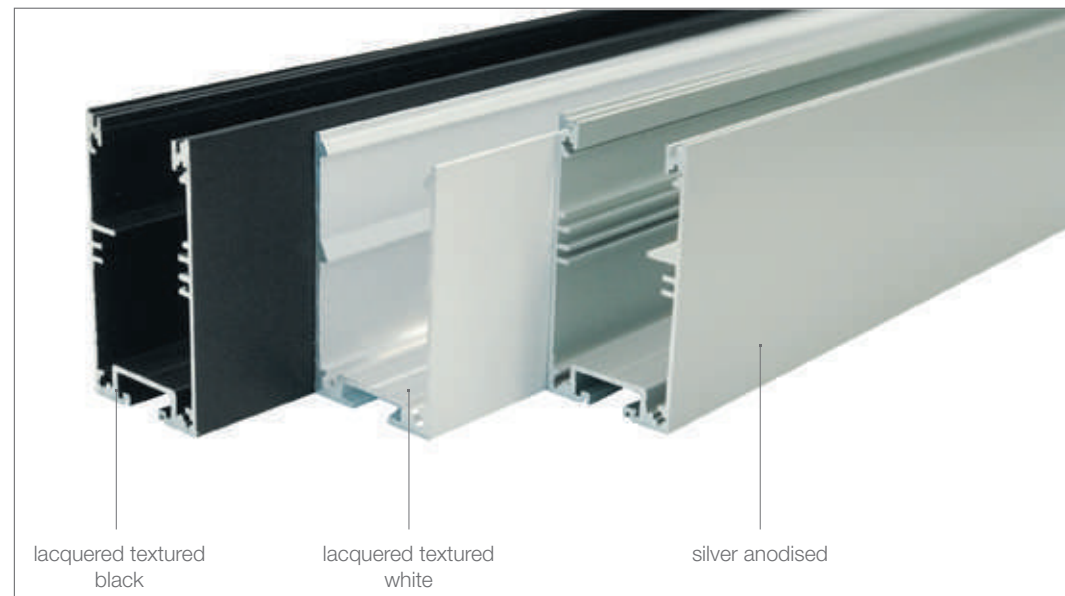

# Covers for led profile

## Polycarbonate covers (4 year guarantee) and methacrylate (2 year guarantee)

Our polycarbonate covers comply with the fire protection standard UL94:VØ and fulfil standards according to the resistance test ISO2039-2: R120/M50. They have a thermal linear expansion coefficient in accordance to ISO 11359-2: 6.5.

They comply with standards according to Charpy impact Strength ISO 179-1:30. UV treatment stabilised in methacrylate covers.

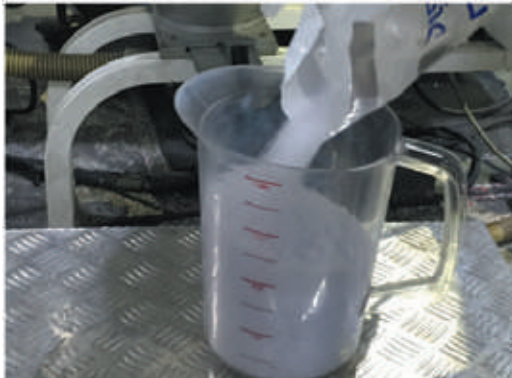

Monomer or polycarbonate chippings



Cover matrix



microprismatic cover

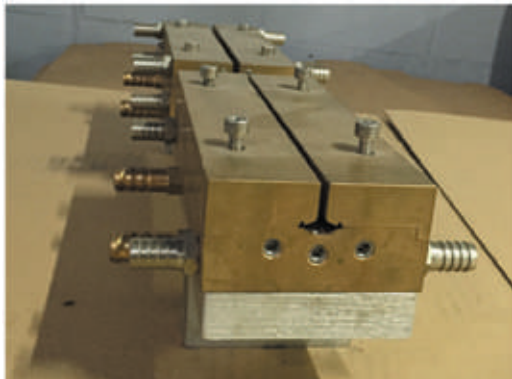

Cover cooler

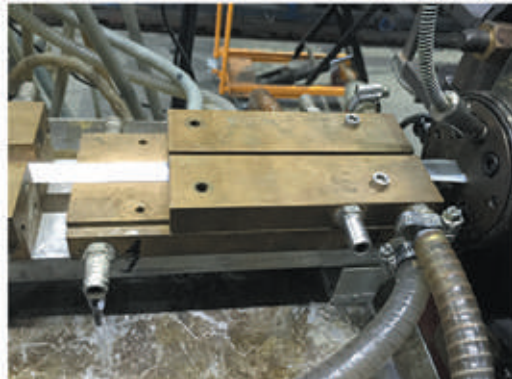

Cover extrusioning



Cover cutter

## Expansion coefficient and material contraction

Changes in temperature can modify material structure and these changes can be seen in aluminium and PMMA where expansion can reach 1.2mm with a temperature of 20°C.

PMMA can reach a linear expansion of 4mm x metre with a temperature variation of 0 to 50°C.

Aluminium (pure)	$23.1 \times 10^{-6} / K$
Polymethylmethacrylate (PMMA)	$80 \times 10^{-6} / K$

FORMULA for calculations:  $\Delta L = \alpha \times L_0 \times \Delta T$   
(Expansion coefficient x initial length x temperature change)

# Covers for led profile

## Led profile covers

**“easy-ON” polycarbonate covers:** greater impact resistance, lower resistance to UV rays (not recommended for direct exterior exposure).

**Acrylic covers:** lower impact resistance and greater resistance to UV rays.

**Blind covers:** opaque, plastic material, suitable for covering areas of profile which are not illuminated (e.g. extreme ends of the profile, where switches or welded parts can be located).

**“easy-ON” optic, polycarbonate cover:** when combined with the profile, the beam angle will be adjusted depending on the distance between led and covers (on all profiles, each specific beam angle has been indicated).

**“easy-ON” treadable IK10 cover:** equipped with UV filters which make the profile suitable for outdoor use, their resistance is also strong enough to endure the weight of a car running over the profile.

**30°-60°-90° methacrylate optic cover:** when applied on the led profile Torino, these clear optic methacrylate covers make the light beam adjustable to different angles.

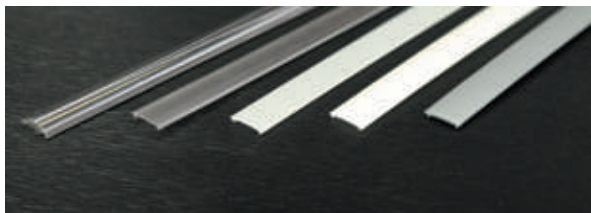

“easy-ON” polycarbonate covers  
Length up to 600cm

Transparent:	95% light transmission
Optic cover:	85% light transmission
Frosted:	70% light transmission
Opal:	55% light transmission
Black&White:	25% light transmission
Opaque:	0% light transmission

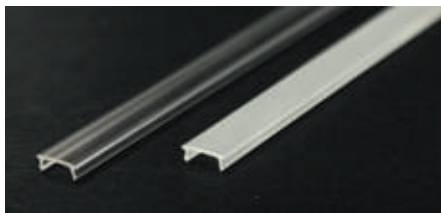

Standard methacrylate covers  
Length up to 600cm clear and frosted



Cover IK10. Length up to 600cm  
Frosted: high resistance to impact and UV rays (only available for the following models: DUBLIN, DUBLIN XL, TOKYO and FLORENCIA)

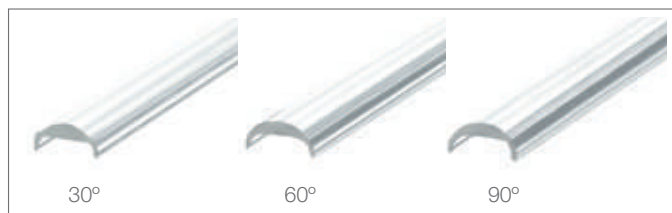

Methacrylate optic covers for led profile TORINO  
Optic 30° - optic 60° - optic 90°

**IMPORTANT NOTE:** when cleaning, no degreasers, diluted solvents or any other kind of aggressive products must be used on the covers, regardless of type, thus preventing instant yellowing or any cracks on their surface.

Cleaning must be carried out using soapy water and avoiding any kind of chemical additives.

## Covers for big profiles

Polycarbonate “easy-ON” covers: greater impact resistance and lower UV ray resistance (not recommended for outside use).

Microprismatic covers: designed to achieve greater light emissions, while at the same time glaring effects and UGR levels are diminished.

Covers equipped with trellis: designed to reduce the glare values while also optimising the use of the light.

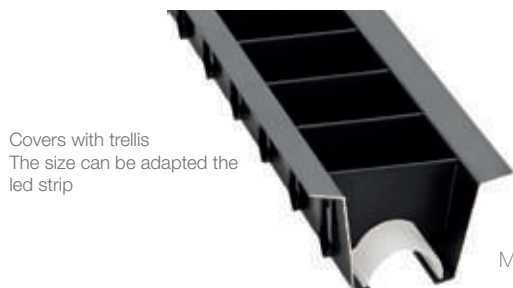

Covers with trellis  
The size can be adapted the led strip

“easy-ON” big profile covers  
Sizes: to 600cm length  
Transparent: 97% light transmission  
Frosted: 75% light transmission  
Opal: 55% light transmission  
Microprism: transparent or frosted  
Microprism frosted: 45% light transmission  
Microprism transparent: 85% light transmission  
Black&White: 20% light transmission

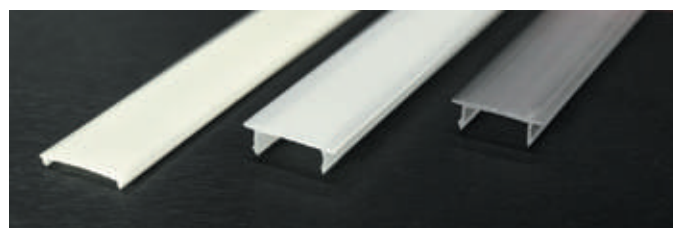



Black&White cover





Black&White is a black cover for led profiles, composed of a special material which allows light to be transmitted once the led is in place. It maintains the RGB and single colour tones in 95% but absorbs luminosity (approx 70%) which means it is used mainly for decorative and not technical lighting.

If we combine it with our black led profiles along with both black end caps and clips it becomes perfectly camouflaged in dark surfaces offering a spectacular and extremely elegant finish. This design finds its maximum expression once combined with digital lighting (please check with our technical department).

Black&White cover (led profile “easy-ON”)

Scale 1:1



MILANO  
See page 44



FRANKFURT  
See page 71



ROMA  
See page 48



BERLIN  
See page 73



PARIS  
See page 94



SOPHIA  
See page 83

Black&White XL cover (led profile “easy-ON”)

Scale 1:1



ROMA XL  
See page 52

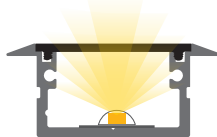

BERLIN XL  
See page 74

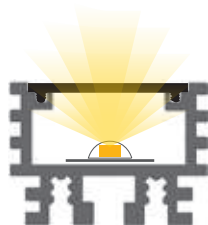

INFERNO  
See page 56

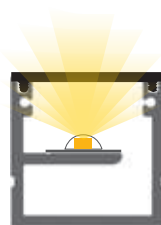

VERSALLES  
See page 54



SOPHIA XL  
See page 84

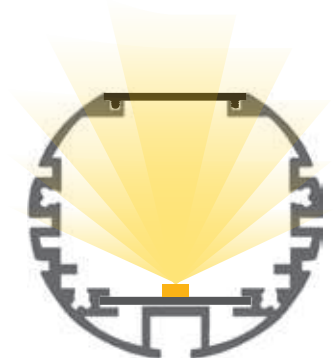

PARIS XL  
See page 100

Black&White slim cover (big profile “easy-ON”)

Scale 1:0.5

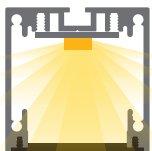

MUNICH MINI  
See page 192

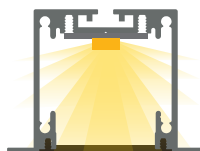

MOSCU MINI  
See page 214

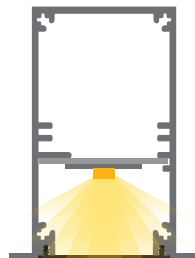

MOSCU SLIM  
See page 220



MUNICH SLIM  
See page 198

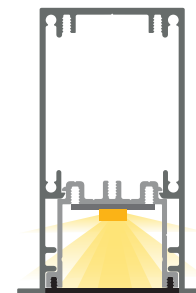

MOSCU MAGNUM  
SLIM  
See page 216

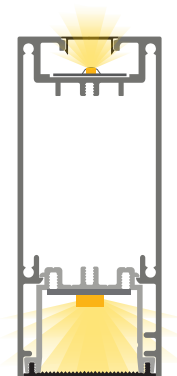

MUNICH MAGNUM  
SLIM  
See page 194

## Black&White mini cover (led profile)

Scale 1:1



NEW YORK MINI  
See page 64



PHILADELPHIA MINI  
See page 78

## Oslo Black&White (led profile)

Scale 1:1

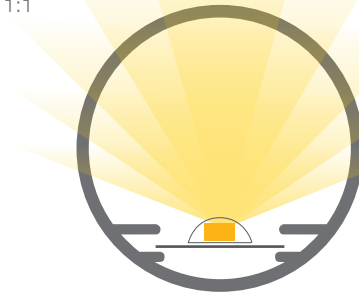

OSLO Black&White  
See page 102



## Black&White XL square cover (led profile)

Scale 1:1



ROMA XL  
See page 52



BERLIN XL  
See page 74

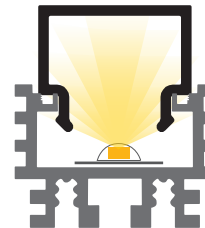

INFERNO  
See page 56

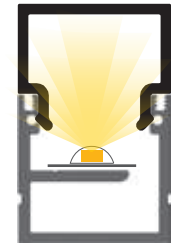

VERSALLES  
See page 54



## Black&Colours

Our Black&White covers accurately reproduce the led colour which we are using and with a variation lower than 5% on the original led colour. This means that it is very suitable not only for single-coloured led strips (white), but also very useful for coloured or RGB led strips.



# Covers and finishes for led profile

## Flex&Cover: Our new treadable and waterproof flexible covers

Here at Luz Negra we have reinvented the concept of covers. Our new Flex&Cover diffuser is manufactured in 3 different types of PVC (chemically treated), which makes it treadable (for floors). It is perfect for outdoor use as it can endure harsh climatological conditions such as rain, snow, heat and UV rays.

Furthermore, its thickness and opacity means that we achieve an improved dot free effect with the leds, even with shallow depths and with flexible strips where there is a considerable distance between the leds.

Initially we designed this cover for embedding directly into wood (without a profile) since its flexibility permits us to light up in a curved fashion. It can also be used with many of our led profiles with high power flexible strips (due to its increased heat dissipation).

Also, since this is a very robust and resistant cover, it can be used level with the flooring as it is treadable. When it is used with our aluminium profiles, the pressure exerted on the profile creates a waterproofing of approximately IP66 (depending on the profile and cover) and that's why it's practical for outdoor use.

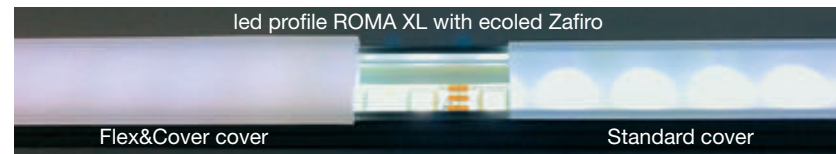
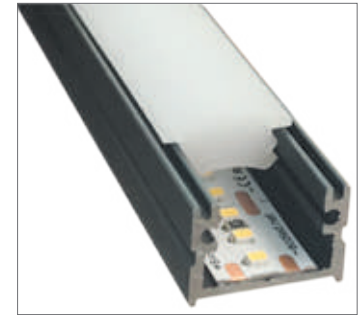

With our new Flex&Cover cover we achieve an improved dots free effect.

## CANNES

11.006 white

Compatible with:

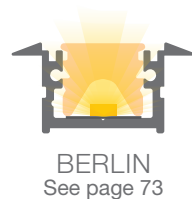
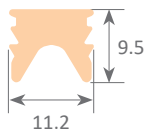

## LILLE

11.008 white

Compatible with:

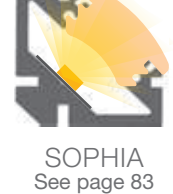
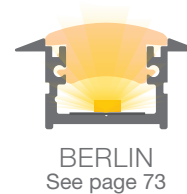
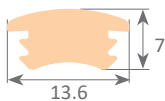

## ARLES

11.010 white

Compatible with:

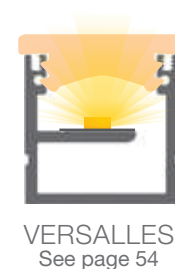
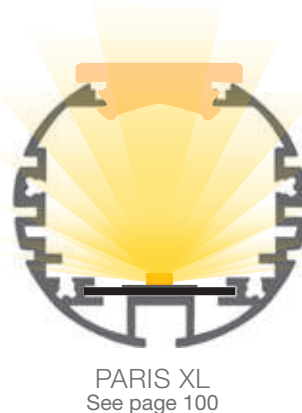
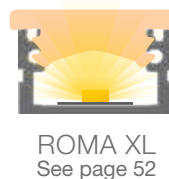
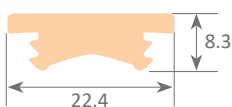

# Covers and finishes for led profile

## Marsella Flex&Cover

Marsella is a plastic cover for indoor use, available in 8 colours. This cover can be used with 6 led profiles and is also suitable for furniture, milled woods or plasterboard.

Its flexibility permits a certain amount of curving when introduced in wood or plasterboard. These colours mentioned below are only for general orientation and will depend on the tone of the led strip used.



## MARSELLA

### Compatible with:

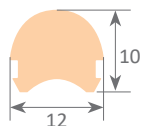

MILANO  
See page 44



FRANKFURT  
See page 71



ROMA  
See page 48

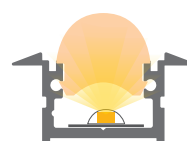

BERLIN  
See page 73



PARIS  
See page 94



SOPHIA  
See page 83

### Colours available in stock:



YELLOW  
Ref: 11.020



GREEN  
Ref: 11.021



BLUE  
Ref: 11.022



WHITE  
Ref: 11.023



ORANGE  
Ref: 11.024



RED  
Ref: 11.025



PINK  
Ref: 11.026



PURPLE  
Ref: 11.027



led profiles for surfaces



MILANO  
44



CALIFORNIA  
46



CALIFORNIA XL  
47



ROMA  
48



NEW YORK  
50



ROMA XL  
52



VERSAILLES  
54



INFERNO  
56



CHICAGO  
58



TORINO  
60



DETROIT  
62



TENNESSEE  
63



NEW YORK  
MINI  
64



BERNA  
65



VISBY  
66



MONTERREY  
67

# led profile by Luz Negra

## MILANO



IP65



Our PROFESSIONAL led profile series for surfaces (only 7mm high) is manufactured in high purity anodised in silver, black and textured white lacquered (the profile can also be supplied in raw aluminium with no coating of paint).

The profile is ideal for using on wall surfaces, furniture, shelves and similar areas, where we require a minimalist profile with very reduced dimensions.

Its cover (available in 9 different finishes), has our "easy-ON" system. Once combined with this profile, it provides an IP65 rating to the luminaire.

This can be used in places with high levels of humidity, for example bathrooms, kitchens, gyms, spas, cold storage chambers, fridges, and others.

The profile and its covers are available in lengths of 2 and 6 metre, thus allowing us to carry out large projects where all profiles do not have joints or similar surface breaks.

It is suitable for led strips with a maximum length of 12mm, whose power level does not exceed 20W/m. In order to obtain a more homogeneous and diffused illumination, we recommend the combined use of our opal cover with Canovelles-Barcelona-Gomera-COB ecoled strips.

**We offer a 10 year guarantee on the profiles and a 4 year guarantee on the covers.**

Scale 1:1

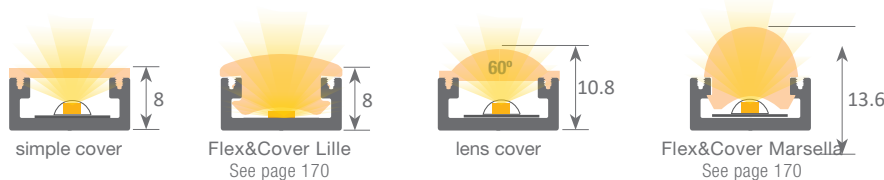

When applying the lens cover on the Milano profile with the flexible led strip we get a beam of 60° light.

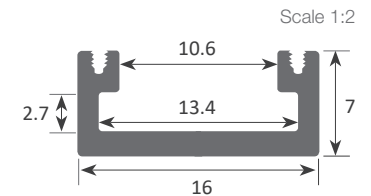

### Aluminium profile

01.001	anodised silver	2m
01.002	anodised black	2m
01.024	white lacquered	2m
01.004	anodised silver	6m
01.005	anodised black	6m
01.023	white lacquered	6m



### Plastic endcaps

19.001	grey without hole
19.002	grey with hole
19.003	black without hole
19.004	black with hole
19.449	black with hole
19.450	black without hole



### Plastic endcaps

19.005	grey without hole lens
19.006	grey with hole lens

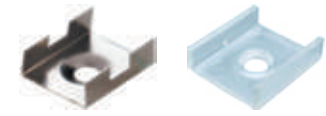

### Clip

20.001	chrome steel
20.002	black oxide finish
20.066	transparent plastic



### Polycarbonate cover "easy-ON"

18.001	transparent	2m
18.002	opal	2m
18.003	frosted	2m
18.004	transparent	6m
18.005	opal	6m
18.006	frosted	6m
18.134	frosted	60m

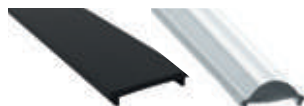

### Black&White cover "easy-ON"

18.007	Black&White	2m
18.008	opaque grey	2m
18.009	Black&White	6m



### Polycarbonate cover

18.140	frosted	2m
18.139	frosted	6m

\*Only for WHITE profile

### Polycarbonate cover "easy-ON"

18.010	lens	2m
18.011	lens	6m

### Polycarbonate cover "easy-ON"

18.135	microprism	2m
18.136	microprism	6m



### New flexible Slim Milano

See page 164



Patente Europea  
Nº.: 13156605.1

Aluminium alloy extrusion process in accordance with: ISO 9001:2008 - ISO 14001 / Tolerances defined by: UNE-EN 755-9 / UNE-EN 12020-2 Theoretical weight: 0.118kg / Alloy: 6063 / Perimeter: 67mm / Anodising minimum: 15 microns  
Aluminium purity: 95-98% / Material treatment: T-5 / Covers: Fireproof V0



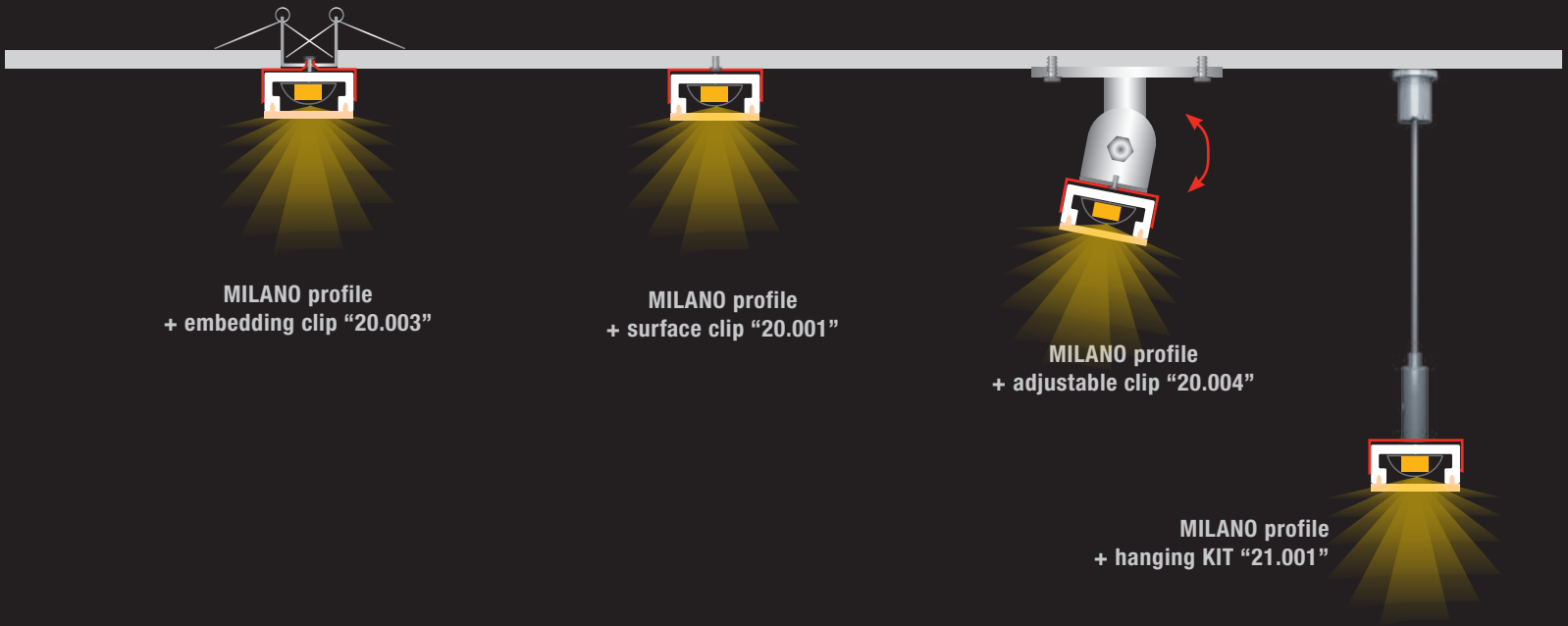

MILANO profile  
+ embedding clip "20.003"

MILANO profile  
+ surface clip "20.001"

MILANO profile  
+ adjustable clip "20.004"

MILANO profile  
+ hanging KIT "21.001"



**Embedding clip**  
20.003 chrome steel  
(clip not included)



**Adjustable bracket**  
20.004 chrome steel  
(clip not included)



**Hanging KIT**  
21.001 chrome set of 2 units  
21.002 white set of 2 units  
21.003 black set of 2 units  
(clip not included)



**90° angle bracket**  
22.001 steel (52x13mm)

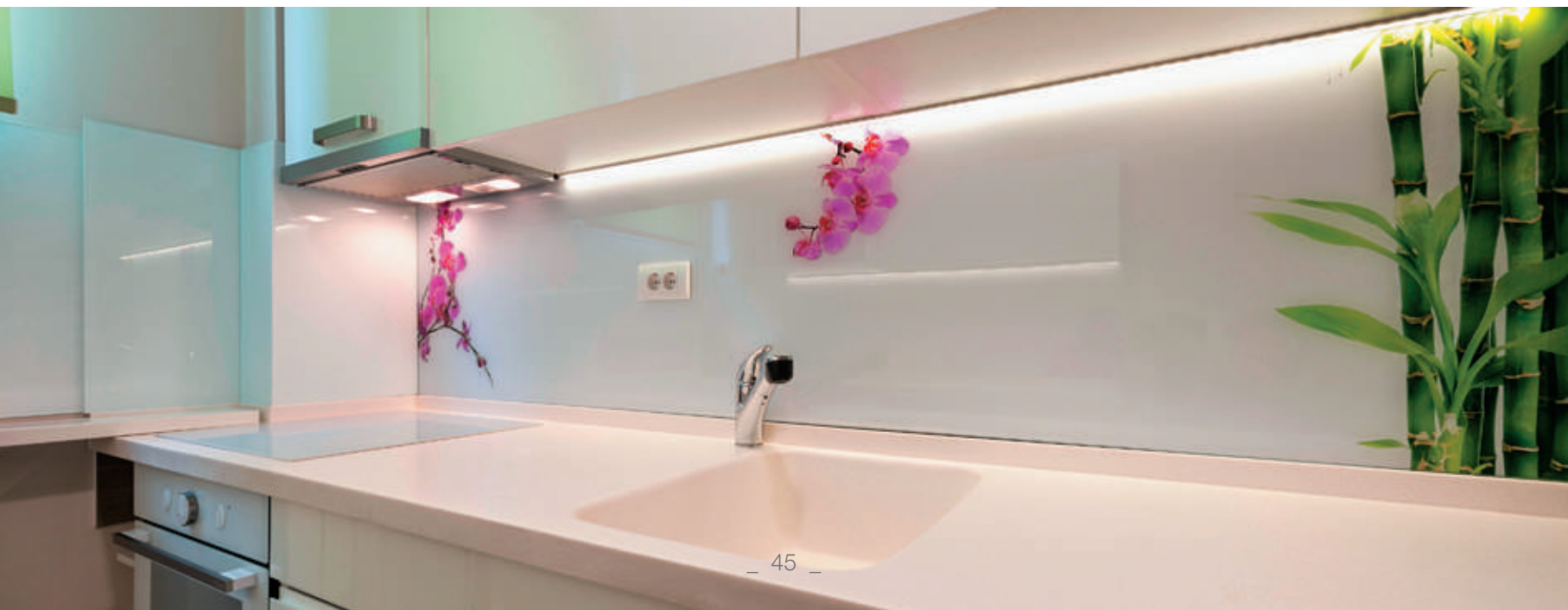

Our BASIC led profile series is only 8mm and for surfaces. Manufactured in high purity aluminium and available in anodised silver, white lacquered, black lacquered and raw aluminium. (On demand it can be supplied with different lacquered/anodised finishes).

Ideal for surface applications, on walls, furniture, bookcases and similar, where we require a minimalist profile with very reduced dimensions.

Suitable for led strips with a maximum width of 14mm and power not greater than 20W/m. We recommend our frosted cover and ecoled strips Canovelles-Barcelona-Gomera-COB to achieve homogenous lighting and without seeing the led dots.

**We offer 2 years guarantee on profiles and covers.**

Scale 1:1



### Aluminium profile

01.007	anodised silver	2m
01.008	white lacquered	2m
01.009	raw	2m
01.022	black lacquered	2m
01.010	anodised silver	6m
01.011	white lacquered	6m
01.012	raw	6m
01.021	black lacquered	6m



### Polycarbonate cover

18.116	opal	2m
18.146	frosted	2m
18.148	opal	2m
18.018	opal	3m
18.115	opal	6m
18.145	frosted	2m
18.147	opal	2m

Scale 1:2



### Plastic endcaps

19.007	white with hole
19.008	white without hole
19.009	grey with hole
19.010	grey without hole
19.439	black with hole
19.440	black without hole



### Methacrylate cover

18.014	transparent	2m
18.015	frosted	2m
18.016	transparent	6m
18.017	frosted	6m



### Clip

20.005	transparent plastic
--------	---------------------



### Embedding clip

20.003	chrome steel
	(clip not included)



### 90° angle bracket

22.001	steel (52x13mm)
--------	-----------------



### Adjustable bracket

20.004	chrome steel
	(clip not included)



Aluminium alloy extrusion process in accordance with: ISO 9001:2008 - ISO 14001 / Tolerances defined by: UNE-EN 755-9 / UNE-EN 12020-2  
Theoretical weight: 0.111kg / Alloy: 6063 / Perimeter: 66mm / Anodising minimum: 15 microns  
Aluminium purity: 95-98% / Material treatment: T-5 / Covers: methacrylate (greater protection against UV rays)

# led profile by Luz Negra

Our BASIC led profile series is for surfaces (only 9.8mm high) and manufactured in high purity aluminium, available in anodised silver. Ideal for wall surfaces, furnitures, shelves and similar. It is suitable for led strips with a maximum width of 20mm, whose power level does not exceed 30W/m.

We recommend our frosted cover and ecoled strips Canovelles-Barcelona-Gomera-COB to achieve homogenous lighting and without seeing the led dots.

**We offer a 2 year guarantee on our profiles and covers.**

## CALIFORNIA XL

Scale 1:1

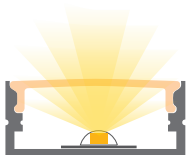

Scale 1:2

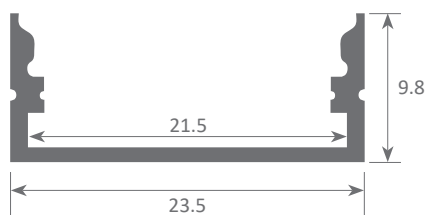

### Aluminium profile

02.011 anodised silver 3m



### Plastic endcaps

19.028 with hole  
19.029 without hole



### Clip

20.011 chrome steel

With double flexible strip of 10mm



### Polycarbonate cover

18.035 frosted 3m



### Adjustable bracket

20.004 chrome steel  
(clip not included)



Aluminium alloy extrusion process in accordance with: ISO 9001:2008 - ISO 14001 / Tolerances defined by: UNE-EN 755-9 / UNE-EN 12020-2  
Theoretical weight: 0.238kg / Alloy: 6063 / Perimeter: 138mm / Anodising minimum: 15 microns  
Aluminium purity: 95-98% / Material treatment: T-5 / Cover: Fireproof VØ

# led profile by Luz Negra

Our PROFESSIONAL led profile series for surfaces (only 11mm high) is manufactured in high purity anodised in silver, black and textured white lacquered (the profile can also be supplied in raw aluminium with no coating of paint).

The profile is ideal for using on wall surfaces, furniture, shelves and similar areas.

Its cover (available in 9 different finishings) has our "easy-ON" system; once combined with this profile it provides an IP65 rating to the luminaire.

The profile and its cover are available in lengths of 2 and 6 metre, thus allowing us to carry out large projects where all the profiles do not have joints or similar surface breaks.

It is suitable for led strips with a maximum width of 12mm, whose power level does not exceed 30W/m. In order to obtain a more homogeneous and diffused illumination, we recommend the combined use of both our opal cover and Canovelles-Barcelona-Gomera-COB ecoled strips.

**We offer a 10 year guarantee on the profiles and a 4 year guarantee on the covers.**

## ROMA



IP65



Scale 1:1

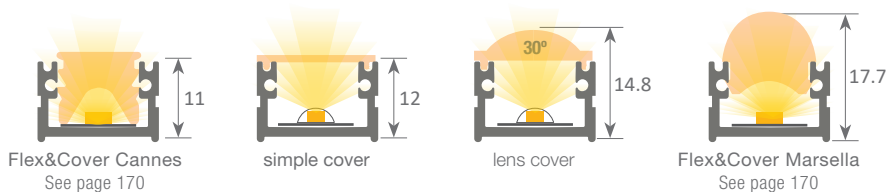

Scale 1:2

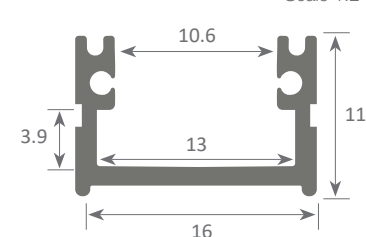

By applying the lens cover on the Roma profile together with the flexible led strip we get a beam of 30° light.



### Aluminium profile

02.001	anodised silver	2m
02.002	anodised black	2m
02.040	white textured lacquered	2m
02.004	anodised silver	6m
02.005	anodised black	6m
02.039	white textured lacquered	6m



### Plastic endcaps

19.016	grey without hole
19.017	grey with hole
19.018	black without hole
19.019	black with hole
19.447	white without hole
19.448	white with hole



### Plastic endcaps

19.020	grey without hole lens
19.021	grey with hole lens



### Clip

20.007	chrome steel
20.008	black oxide finish



### Polycarbonate cover "easy-ON"

18.001	transparent	2m
18.002	opal	2m
18.003	frosted	2m
18.004	transparent	6m
18.005	opal	6m
18.006	frosted	6m
18.134	frosted	60m

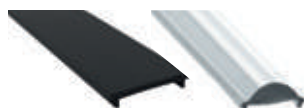

### Black&White cover "easy-ON"

18.007	Black&White	2m
18.008	opaque grey	2m
18.009	Black&White	6m

### Polycarbonate cover "easy-ON"

18.010	lens	2m
18.011	lens	6m

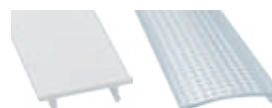

### Polycarbonate cover

18.140	frosted	2m
18.139	frosted	6m

\*Only for WHITE profile

### Polycarbonate cover "easy-ON"

18.135	microprism	2m
18.136	microprism	6m



Aluminium alloy extrusion process in accordance with: ISO 9001:2008 - ISO 14001 / Tolerances defined by: UNE-EN 755-9 / UNE-EN 12020-2  
Theoretical weight: 0.143kg / Alloy: 6063 / Perimeter: 90mm / Anodising minimum: 15 microns  
Aluminium purity: 95-98% / Material treatment: T-5 / Cover: Fireproof V0

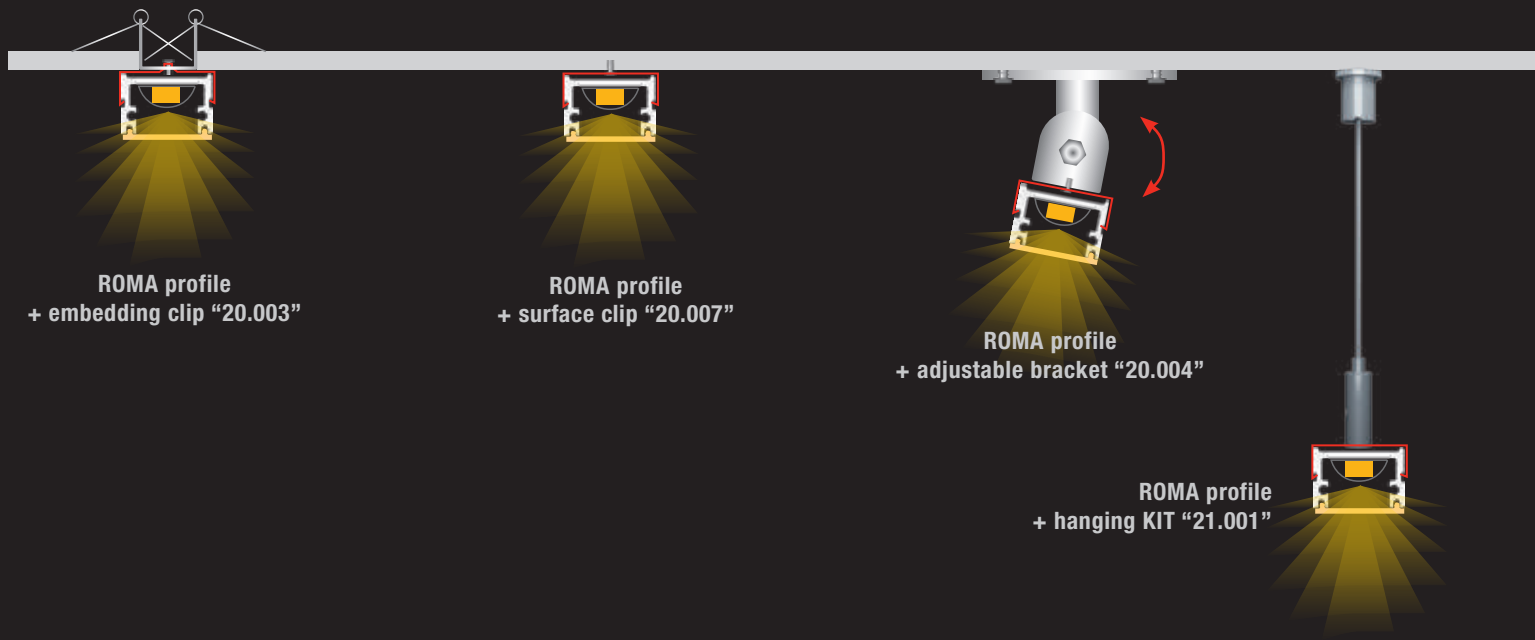

ROMA profile  
+ embedding clip "20.003"

ROMA profile  
+ surface clip "20.007"

ROMA profile  
+ adjustable bracket "20.004"

ROMA profile  
+ hanging KIT "21.001"



**Embedding clip**  
20.003 chrome steel  
(clip not included)



**Adjustable bracket**  
20.004 chrome steel  
(clip not included)



**Hanging KIT**  
21.001 chrome set of 2 units  
21.002 white set of 2 units  
21.003 black set of 2 units  
(clip not included)



**90° angle bracket**  
22.001 steel (52x13mm)



Our BASIC led profile series for surfaces is manufactured in high purity aluminium and available in anodised silver, lacquered white, lacquered black and raw aluminium (on demand we can supply different anodised and lacquered finishes). Ideal for wall surfaces, furniture, shelves and similar. Suitable for led strips with a maximum width of 14mm and a power not greater than 30W/m. In order to obtain a more homogeneous illumination, while also making the dots invisible, we recommend the combined use of both our frosted cover and Canovelles-Barcelona-Gomera-COB ecoled strips.

**We offer a 2 year guarantee on our profiles and covers.**



Scale 1:2

Scale 1:1

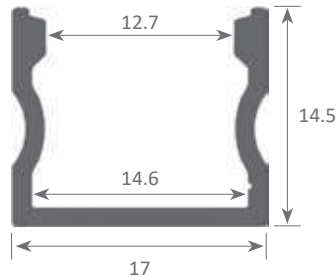

### Aluminium profile

02.012	anodised silver	2m
02.013	white lacquered	2m
02.014	raw	2m
02.038	black lacquered	2m
02.015	anodised silver	6m
02.016	white lacquered	6m
02.017	raw	6m
02.037	black lacquered	6m

### Plastic endcaps

19.030	white with hole
19.031	white without hole
19.032	grey with hole
19.033	grey without hole
19.441	black with hole
19.442	black without hole

### Clip

20.005	transparent plastic
--------	---------------------



### Embedding clip

20.003	chrome steel
	(clip not included)

### 90° angle bracket

22.001	steel (52x13mm)
--------	-----------------



### Adhesive magnet

42.001	12mm	1m
--------	------	----



### Polycarbonate cover

18.116	opal	2m
18.146	frosted	2m
18.148	opal	2m
18.018	opal	3m
18.115	opal	6m
18.145	frosted	2m
18.147	opal	2m



### Methacrylate cover

18.014	transparent	2m
18.015	frosted	2m
18.016	transparent	6m
18.017	frosted	6m



### Adjustable bracket

20.004	chrome steel
	(clip not included)



Aluminium alloy extrusion process in accordance with: ISO 9001:2008 - ISO 14001 / Tolerances defined by: UNE-EN 755-9 / UNE-EN 12020-2  
Theoretical weight: 0.157kg / Alloy: 6063 / Perimeter: 92mm / Anodising minimum: 15 microns  
Aluminium purity: 95-98% / Material treatment: T-5 / Covers: methacrylate (greater protection against UV rays)



Our PROFESSIONAL led profile series for surfaces is manufactured in high purity aluminium and available in anodised silver, black and white lacquered. The profile is ideal for using on wall surfaces, furniture, shelves and similar areas where a width greater than the standard is required. This allows us to use wider led strips for an increased heat dissipation and a wider angle of light emission.

Its cover (available in 8 different finishings), has our "easy-ON" system. Once combined with this profile, it provides an IP65 rating to the luminaire.

The profile and its covers are available in lengths of 2 and 6 metre, thus allowing us to carry out large projects where all the profiles do not have joints or similar surface breaks.

It is suitable for led strips with a maximum width of 15mm, whose power level does not exceed 35W/m. In order to obtain a more homogeneous and diffused illumination, we recommend the combined use of both our opal cover and Canovelles-Barcelona-Gomera-COB ecoled strips.

**We offer a 10 year guarantee on the profiles and a 4 year guarantee on the covers.**

## ROMA XL



IP65

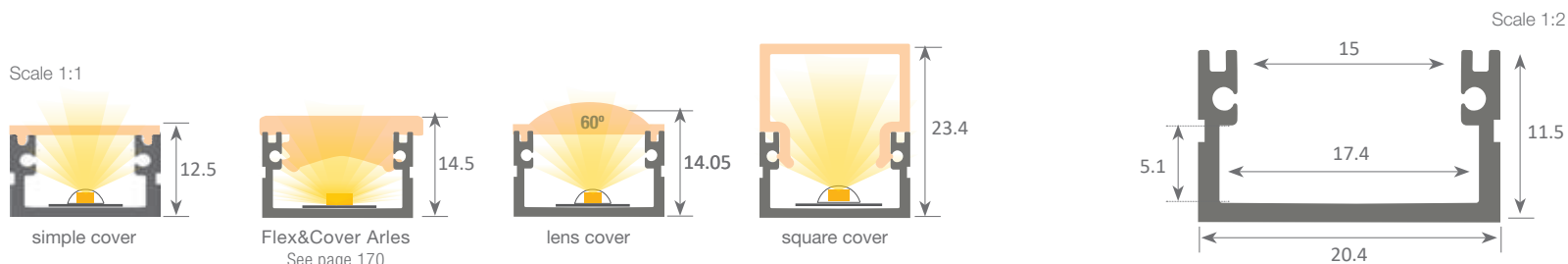

By applying the lens cover on the Roma XL profile together with the flexible led strip we get a beam of 60° light.



### Aluminium profile

02.007	anodised silver	2m
02.008	anodised black	2m
02.035	white lacquered	2m
02.009	anodised silver	6m
02.010	anodised black	6m
02.034	white lacquered	6m



### Plastic endcaps

19.022	grey without hole
19.023	grey with hole
19.427	white without hole
19.428	white with hole



### Plastic endcaps

19.024	black without hole
19.025	black with hole



### Endcaps for square cover

19.026	white without hole
19.027	black without hole



### Polycarbonate cover "easy-ON"

18.022	transparent	2m
18.023	opal	2m
18.024	frosted	2m
18.030	lens	2m
18.025	transparent	6m
18.026	opal	6m
18.027	frosted	6m
18.031	lens	6m



### Black&White cover "easy-ON"

18.028	Black&White	2m
18.029	Black&White	6m

### Polycarbonate cover

18.127	frosted	2m
18.126	frosted	6m

\*Only for WHITE XL profile



### Polycarbonate cover "easy-ON"

18.130	microprism	2m
18.129	microprism	6m

### Polycarbonate cover with side wings

18.132	frosted	2m
18.131	frosted	6m

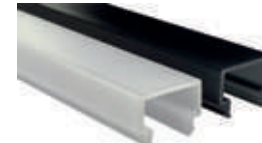

### Square cover

18.032	frosted	2m
18.102	Black&White	2m
18.033	frosted	6m
18.034	Black&White	6m



Aluminium alloy extrusion process in accordance with: ISO 9001:2008 - ISO 14001 / Tolerances defined by: UNE-EN 755-9 / UNE-EN 12020-2  
Theoretical weight: 0.162kg / Alloy: 6063 / Perimeter: 102mm / Anodising minimum: 15 microns  
Aluminium purity: 95-98% / Material treatment: T-5 / Cover: Fireproof V0



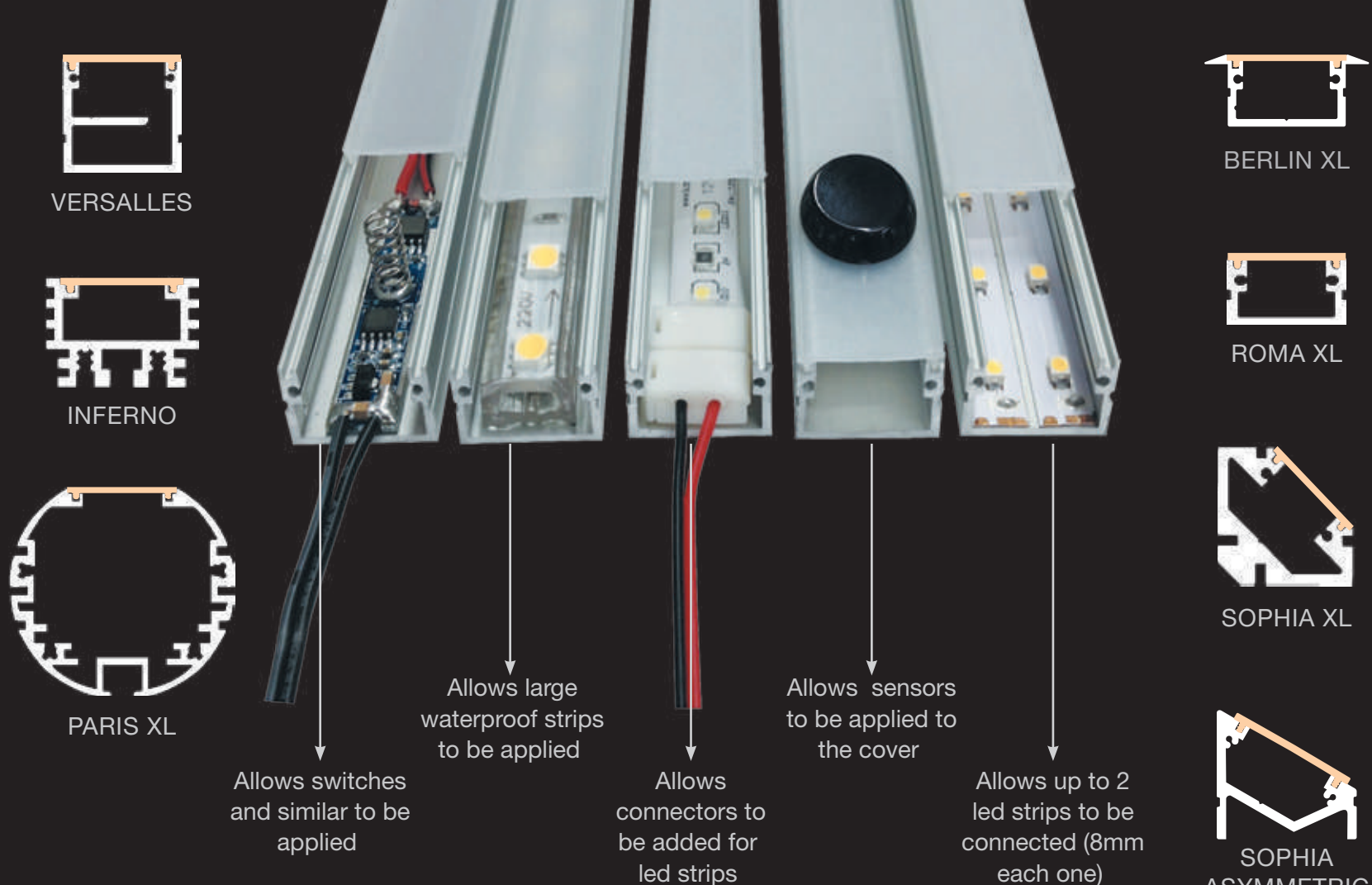

VERSALLES

BERLIN XL

INFERNO

ROMA XL

PARIS XL

SOPHIA XL

SOPHIA ASYMMETRIC

Allows switches and similar to be applied

Allows large waterproof strips to be applied

Allows connectors to be added for led strips

Allows sensors to be applied to the cover

Allows up to 2 led strips to be connected (8mm each one)

## ¿Why choose led profile XL?

Our led profiles XL are slightly larger than our standard profiles in order to house many different accessories inside, something that can't be done with other models due to the lack of space and wider led strips.

They have a cover which is 25% wider than the rest and that means a 25% increase in light projection. Bigger in size also means greater heat dissipation which is extremely important when it comes to high luminosity led strips.



**Clip**  
20.009 stainless steel  
20.010 black oxide finish



**Embedding clip**  
20.003 chrome steel  
(clip not included)



**Adjustable bracket**  
20.004 chrome steel  
(clip not included)



**Hanging KIT**  
21.001 chrome set of 2 units  
21.002 white set of 2 units  
21.003 black set of 2 units  
(clip not included)



**90° angle bracket**  
22.001 steel (52x13mm)

## VERSALLES



IP65



Our PROFESSIONAL led profile series for surfaces is manufactured in high purity aluminium and available in anodised silver, black and white lacquered. This profile is ideal for using on wall surfaces, furniture, shelves and similar areas, where a width greater than the standard is required. This allows us to use wider led strips for an increased heat dissipation and a wider angle of light emission.

By providing a lower channel for the return path of the cable, the profile allows us to close the circuit therefore steep voltage drops are prevented. Small drivers can also be placed in this lower channel.

Its cover (available in 7 different finishings), which offers our “easy-ON” system, once combined with this profile provides an IP65 rating to the luminaire. It can be used in places with high levels of humidity, such as bathrooms, kitchens, gyms, spas, cold storage chambers, fridges, or others.

The profile and its covers are available in lengths of 2 and 6 metre, thus allowing us to carry out large projects, where all the profiles do not require joints or similar surface breaks. It is suitable for led strips with a maximum width of 15mm, whose power level does not exceed 35W/m. In order to obtain a more homogeneous and diffused illumination, we recommend the combined use of both our opal covers and Canovelles-Barcelona-Gomera-COB ecoled strips.

**We offer a 10 year guarantee on the profiles and a 4 year guarantee on the covers.**

Scale 1:1

By applying the lens cover on the Versalles profile together with the flexible led strip we get a beam of 60° light.

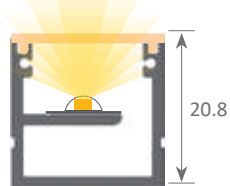

simple cover

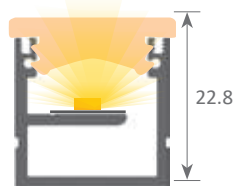

Flex&Cover Arles  
See page 170

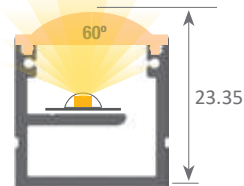

lens cover

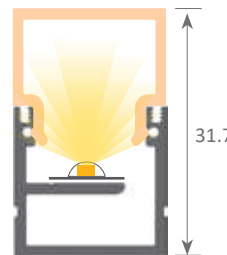

square cover

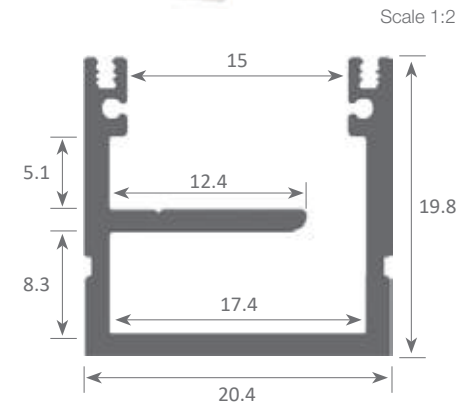

Scale 1:2

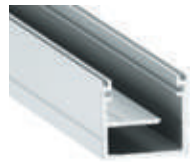

### Aluminium profile

02.018	anodised silver	2m
02.019	anodised black	2m
02.036	white lacquered	2m
02.020	anodised silver	6m
02.021	anodised black	6m
02.033	white lacquered	6m



### Plastic endcaps

19.034	grey without hole
19.293	black without hole
19.429	white without hole



### Endcaps for square cover

19.035	without hole (white)
19.036	without hole (black)



### Clip

20.009	stainless steel
20.010	black oxide finish

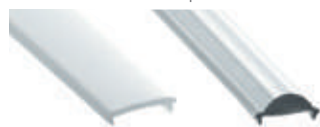

### Polycarbonate cover “easy-ON”

18.022	transparent	2m
18.023	opal	2m
18.024	frosted	2m
18.030	lens	2m
18.025	transparent	6m
18.026	opal	6m
18.027	frosted	6m
18.031	lens	6m

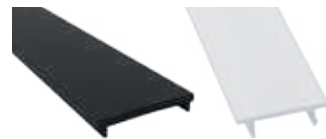

### Black&White cover “easy-ON”

18.028	Black&White	2m
18.029	Black&White	6m

### Polycarbonate cover

18.127	frosted	2m
18.126	frosted	6m

\*Only for WHITE profile

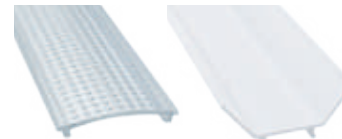

### Polycarbonate cover “easy-ON”

18.130	micropism	2m
18.129	micropism	6m

### Polycarbonate cover with side wings

18.132	frosted	2m
18.131	frosted	6m

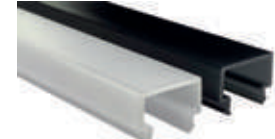

### Square cover

18.032	frosted	2m
18.102	Black&White	2m
18.033	frosted	6m
18.034	Black&White	6m



Patente Europea  
Nº.: 13156605.1

Aluminium alloy extrusion process in accordance with: ISO 9001:2008 - ISO 14001 / Tolerances defined by: UNE-EN 755-9 / UNE-EN 12020-2  
Theoretical weight: 0.273kg / Alloy: 6063 / Perimeter: 159mm / Anodising minimum: 15 microns  
Aluminium purity: 95-98% / Material treatment: T-5 / Covers: Fireproof V0

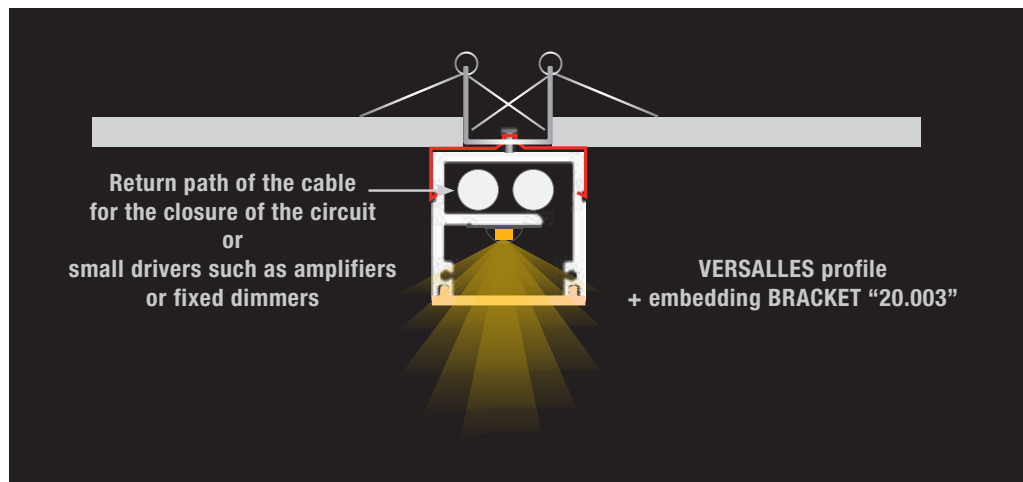

**Embedding clip**

20.003 chrome steel  
(clip not included)



**Adjustable bracket**

20.004 chrome steel  
(clip not included)



**Hanging KIT**

21.001 chrome set of 2 units  
21.002 white set of 2 units  
21.003 black set of 2 units  
(clip not included)

# led profile by Luz Negra

Our PROFESSIONAL led profile series for surfaces and ceiling suspension is manufactured in high purity aluminium and available in silver and black anodised. Ideal for wall surfaces, furniture, shelves and similar areas where a width greater than the standard is required. This allows us to use wider led strips for an increased heat dissipation and a wider angle of light emission.

Thanks to its radiator-like design, this profile achieves greater levels of heat dissipation when compared to any other type. By using its lower channels, the manufacturing of square, rectangular or L-shaped hanging luminaires is also possible.

Its cover (available in 8 different finishing) has our "easy-ON" system. Once combined with this profile, it provides an IP65 rating to the luminaire. Hence, it can be used in places with high levels of humidity, such as bathrooms, kitchens, gyms, spas, cold storage chambers, fridges, or others. We recommend using it with our Canovelles-Barcelona-Gomera-COB ecoled strips.

**We offer a 10 year guarantee on the profiles and a 4 year guarantee on the covers.**

## INFERNO



IP65



Scale 1:1

By applying the lens cover on the Inferno profile together with the flexible led strip we get a beam of 45° light. The information is just approximate. Please check with our technical department.

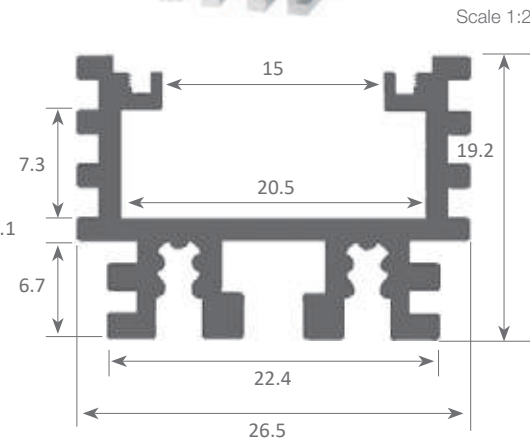
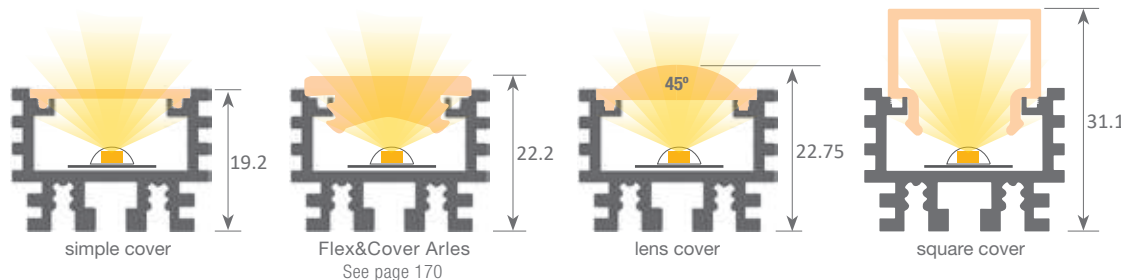

Scale 1:2



### Aluminium profile

02.022	anodised silver	2m
02.023	anodised black	2m
02.024	anodised silver	6m
02.025	anodised black	6m



### Plastic endcaps

19.037	grey without hole
19.039	black without hole
19.040	black with hole



### Aluminium endcaps

19.041	anodised silver without hole
19.042	anodised black with hole



### Endcaps for square cover

19.043	without hole (white)
19.044	without hole (black)



### Polycarbonate cover "easy-ON"

18.022	transparent	2m
18.023	opal	2m
18.024	frosted	2m
18.025	transparent	6m
18.026	opal	6m
18.027	frosted	6m



### Black&White cover

18.028	Black&White	2m
18.029	Black&White	6m



### Polycarbonate cover "easy-ON"

18.030	lens	2m
18.031	lens	6m

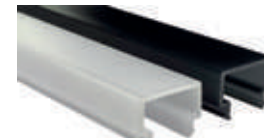

### Square cover

18.032	frosted	2m
18.102	Black&White	2m
18.033	frosted	6m
18.034	Black&White	6m



Patente Europea  
Nº.: 13156605.1

Aluminium alloy extrusion process in accordance with: ISO 9001:2008 - ISO 14001 / Tolerances defined by: UNE-EN 755-9 / UNE-EN 12020-2  
Theoretical weight: 0.446kg / Alloy: 6063 / Perimeter: 211mm / Anodising minimum: 15 microns  
Aluminium purity: 95-98% / Material treatment: T-5 / Covers: Fireproof V0

The increase in distance from the wall improves the ventilation levels, allowing us to obtain a higher rating of heat dissipation

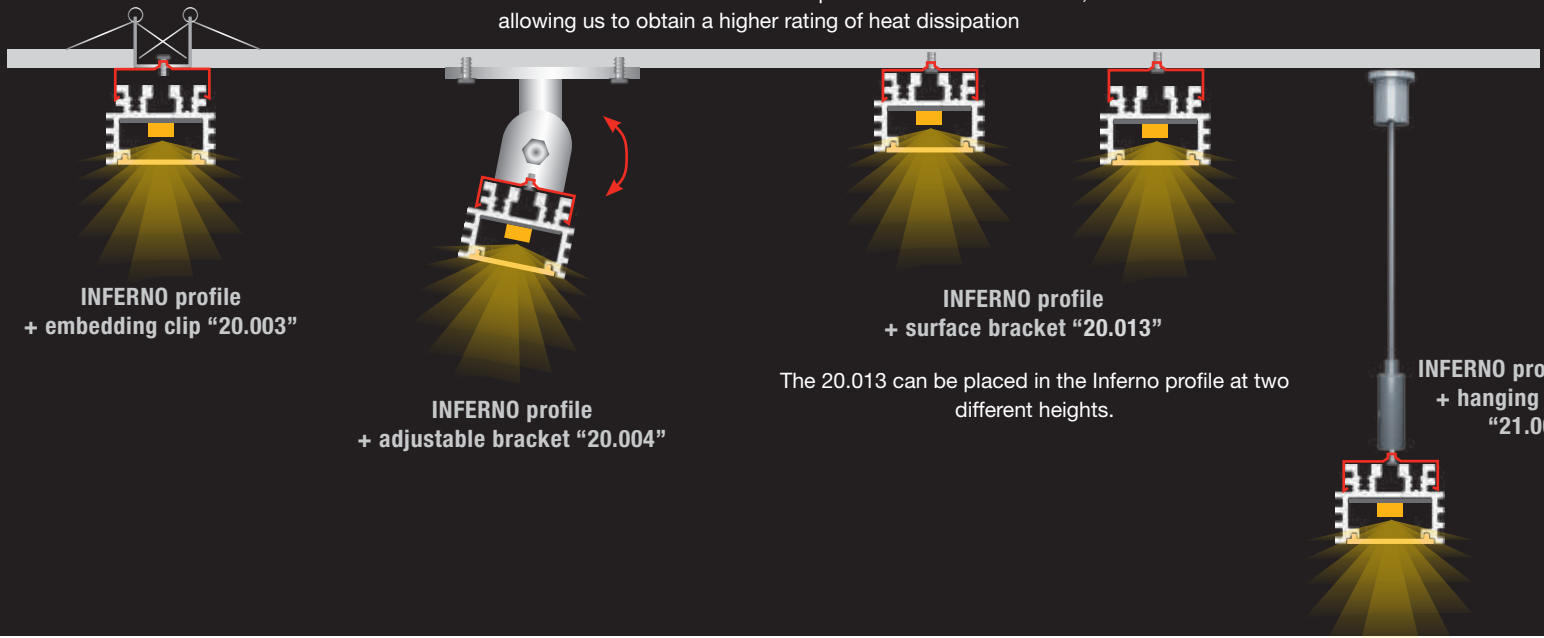

INFERNO profile  
+ embedding clip "20.003"

INFERNO profile  
+ adjustable bracket "20.004"

INFERNO profile  
+ surface bracket "20.013"

The 20.013 can be placed in the Inferno profile at two different heights.

INFERNO profile  
+ hanging KIT  
"21.001"



**Clip**  
20.012 chrome steel  
20.013 black oxide finish



**Adjustable bracket**  
20.004 chrome steel  
(clip not included)



**Embedding clip**  
20.003 chrome steel  
(clip not included)



**Hanging KIT**  
21.001 chrome set of 2 units  
21.002 white set of 2 units  
21.003 black set of 2 units  
(clip not included)



**90° angle bracket**  
22.003 steel



**120° angle bracket**  
22.004 steel



**Profile joint**  
22.005 steel

**120° angle bracket**  
22.004

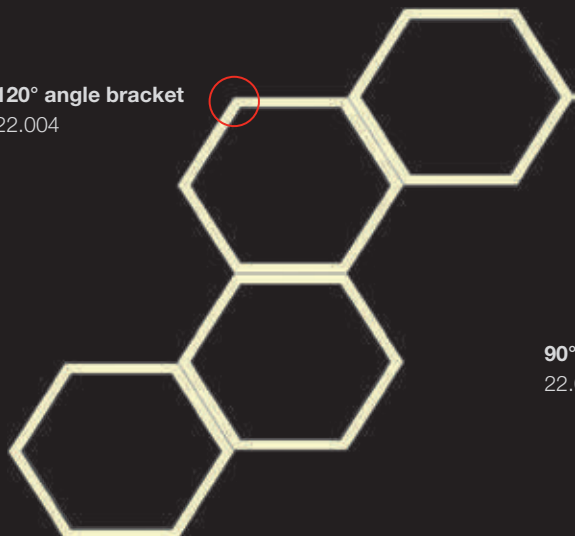

**90° angle bracket**  
22.003

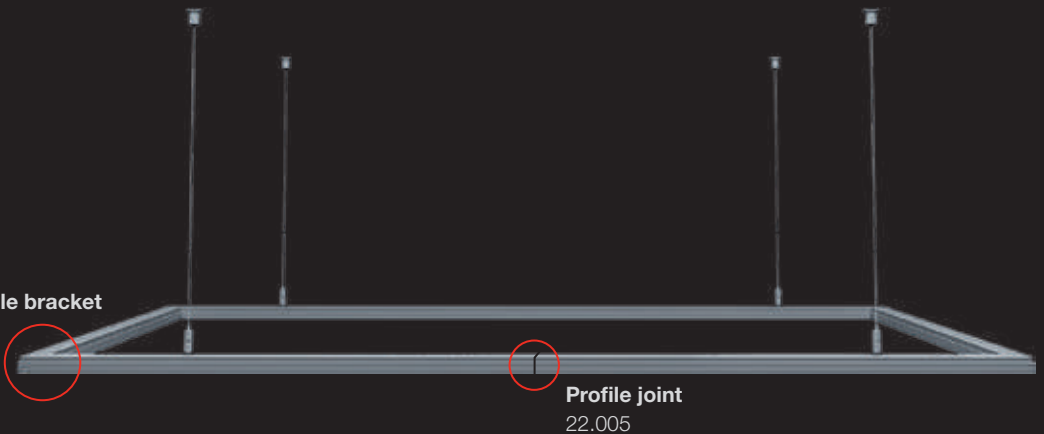

**Profile joint**  
22.005

## CHICAGO

Our PROFESSIONAL led profile series is for surfaces or embedding with a width of only 6mm and manufactured in high purity aluminium and anodised in silver. The very latest in thin led profiles as the width of visible light is only 2.5mm. Its main function is for embedding in furniture and wherever we may need a very fine line of light. This is a very elegant and exclusive product.

We recommend the use of ecoled Getafe and Irún due to its extremely thin PCB and for side lighting.

**We offer a 2 year guarantee on both profiles and covers.**



Scale 1:1

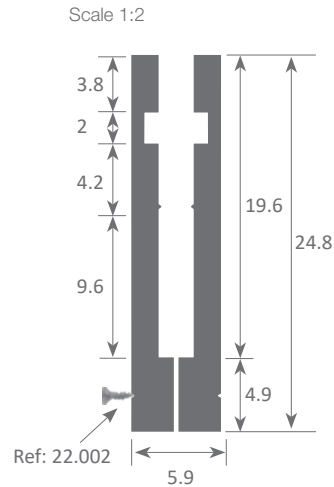

**Aluminium profile**  
01.015 anodised silver 1m



**Endcaps**  
19.014 without hole  
19.015 with hole



**Methacrylate cover**  
18.021 opal 1m  
(to simply installation we recommend fixing the cover with double sided tape).



**Fixing screw**  
22.002 chrome steel

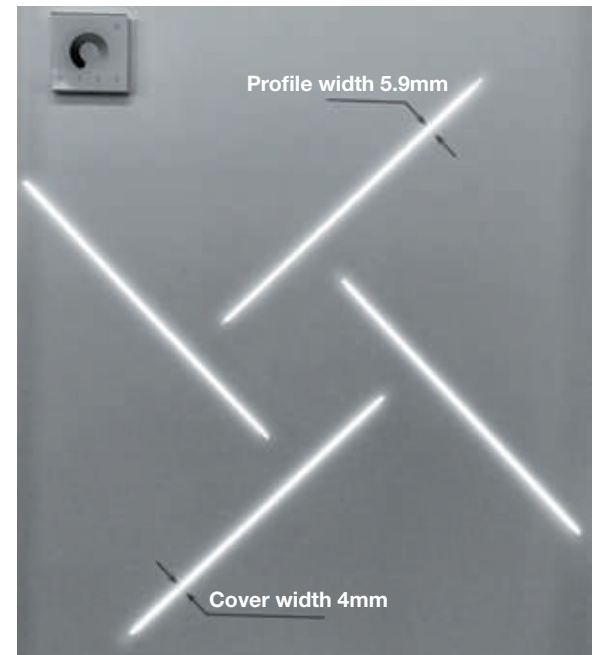

Aluminium alloy extrusion process in accordance with: ISO 9001:2008 - ISO 14001 / Tolerances defined by: UNE-EN 755-9 / UNE-EN 12020-2  
Theoretical weight: 0.285kg / Alloy: 6063 / Perimeter: 116.6mm / Anodising minimum: 15 microns  
Aluminium purity: 95-98% / Material treatment: T-5 / Covers: methacrylate (greater protection against UV rays)



# led profile by Luz Negra

Our PROFESSIONAL led profile series for surfaces and corners, due to its bevelled shape, can also be used as a corner profile. It is manufactured in high purity aluminium and available in anodised silver. Ideal for surfaces, corners, furniture, shelves and similar.

It can be combined with our 30°/60°/90° optic covers or with our white frosted cover.

Suitable for led strips with a maximum width of 12mm and a power not greater than 30W/m. In order to obtain a more homogeneous illumination, while also making the dots invisible, we recommend the combined use of both our frosted cover and Canovelles-Barcelona-Gomera-COB ecoled strips.

**We offer a 2 year guarantee on our profiles and covers.**

## TORINO



Torino with frosted cover

Torino with lens

Scale 1:2

Scale 1:1

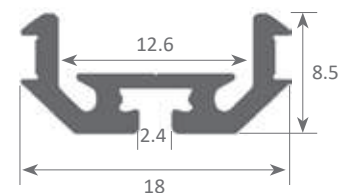
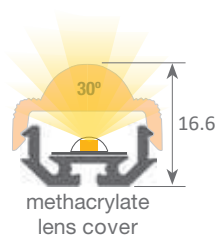
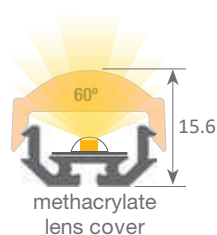
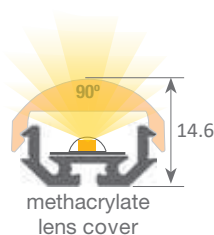
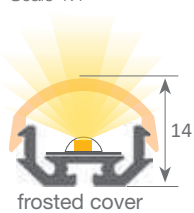

### Aluminium profile

02.026 anodised silver 2m  
02.027 anodised silver 6m

### Aluminium endcaps

19.045 for 30° lens  
19.046 for 60° lens  
19.464 for 60° lens whit hole  
19.047 for 90° lens and frosted cover 18.039

### Clip

20.014 transparent plastic



### Methacrylate cover

18.036 30° lens 2m



### Methacrylate cover

18.037 60° lens 2m



### Methacrylate cover

18.038 90° lens 2m



### Methacrylate cover

18.039 frosted 2m



Aluminium alloy extrusion process in accordance with: ISO 9001:2008 - ISO 14001 / Tolerances defined by: UNE-EN 755-9 / UNE-EN 12020-2  
Theoretical weight: 0.154kg / Alloy: 6063 / Perimeter: 86mm / Anodising minimum: 15 microns  
Aluminium purity: 95-98% / Material treatment: T-5 / Covers: Fireproof V0



Project carried out by ESTUDI314BCN  
Led profile + ecoled flexible led strips by Luz Negra



# led profile by Luz Negra

## DETROIT

Our BASIC led profile series for surfaces is only 8mm width, manufactured in high purity aluminium and anodised in silver (on demand can be supplied with different lacquered/anodised finishing). Ideal for surface applications, on walls, furniture, bookcases and similar, where we require a minimalist profile with very reduced dimensions.

Suitable for led strips with a maximum width of 5mm and power not greater than 16W/m. We recommend the use of ecoled Cies due to its PCB (only 5mm wide).

**We offer 2 years guarantee on profiles and covers.**



Scale 1:1



Scale 1:2

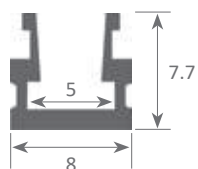

### Aluminium profile

01.013 anodised silver 2m



### Plastic endcaps

19.011 white with hole  
19.360 gray with hole  
19.332 gray without hole



### Clip

20.006 chrome steel



### Polycarbonate cover

18.019 opal 2m



### Adjustable bracket

20.004 chrome steel  
(clip not included)



Aluminium alloy extrusion process in accordance with: ISO 9001:2008 - ISO 14001 / Tolerances defined by: UNE-EN 755-9 / UNE-EN 12020-2  
Theoretical weight: 0.080kg / Alloy: 6063 / Perimeter: 18.2mm / Anodising minimum: 15 microns  
Aluminium purity: 95-98% / Material treatment: T-5 / Covers: methacrylate (greater protection against UV rays)

# led profile by Luz Negra

## TENNESSEE

Our BASIC led profile series for surfaces is only 8mm high and manufactured in high purity anodised aluminium.

This profile is ideal for using on wall surfaces, furniture, shelves and similar areas, where we require a minimalist profile with very reduced dimensions. Its white cover completely embraces the profile and provides a greater angle of light emission.

It is suitable for led strips with a maximum width of 10mm, whose power level does not exceed 20W/m. In order to obtain a more homogeneous illumination, while also making the dots invisible, we recommend the combined use of both our opal cover and Canovelles-Barcelona-Gomera-COB ecoled strips.

**We offer a 2 year guarantee on both profiles and covers.**



Scale 1:1

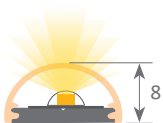

Scale 1:2

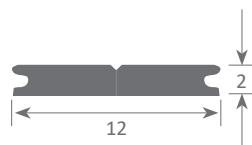

### Aluminium profile

01.014 anodised silver 2m



### Plastic integrated endcaps

19.357 gray without hole  
19.358 gray with hole



### Polycarbonate cover

18.020 opal 2m



Aluminium alloy extrusion process in accordance with: ISO 9001:2008 - ISO 14001 / Tolerances defined by: UNE-EN 755-9 / UNE-EN 12020-2  
Theoretical weight: 0.061kg / Alloy: 6063 / Perimeter: 30.4mm / Anodising minimum: 15 microns  
Aluminium purity: 95-98% / Material treatment: T-5 / Covers: methacrylate (greater protection against UV rays)

# led profile by Luz Negra

Our BASIC led profile series for surfaces is manufactured in high purity aluminium and available in anodised silver and black (on demand we can supply different anodised and lacquered finishings). Ideal for wall surfaces, furniture, shelves and similar.

Suitable for led strips with a maximum width of 5mm and a power not greater than 15W/m. In order to obtain a more homogeneous illumination, while also making the dots invisible, we recommend the combined use of both our frosted cover and Cies ecoled strips.

**We offer a 2 year guarantee on our profiles and covers.**

## NEW YORK MINI



Scale 1:1



Scale 1:2

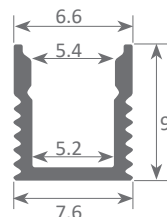

### Aluminium profile

02.029 anodised silver 3m  
02.030 anodised black 3m



### Plastic endcaps

19.215 white with hole  
19.216 white without hole  
19.288 black without hole  
19.287 black with hole



### Clip

20.049 chrome steel

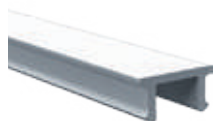

### Polycarbonate cover

18.081 frosted 3m



### Black&White cover

18.085 Black&White 3m



### Adjustable bracket

20.004 chrome steel  
(clip not included)



Aluminium alloy extrusion process in accordance with: ISO 9001:2008 - ISO 14001 / Tolerances defined by: UNE-EN 755-9 / UNE-EN 12020-2  
Alloy: 6063 / Anodising minimum: 15 microns  
Aluminium purity: 95-98% / Material treatment: T-5 / Covers: methacrylate (greater protection against UV rays)

# led profile by Luz Negra

## BERNA

Our BASIC led profile series for surfaces, manufactured in curved aluminium is available in lacquered white (on demand, we can supply different anodised and lacquered finishes). Ideal for wall surfaces, ceilings, display units, furniture, shelves and similar. It is fixed using single or double-sided magnetic adhesive tape.

Suitable for led strips with a maximum width of 35mm and a power not greater than 35W/m. Apart from the flexible led strips, rigid ones can also be combined with this profile).

In order to obtain a more homogeneous illumination, while also making the light dots invisible, we recommend the use of our Canovelles-Barcelona-Gomera-COB ecoled strips.

**We offer a 2 year guarantee on our profiles and covers.**



Scale 1:1

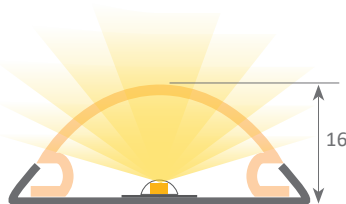

### Aluminium profile

02.028 white aluminium 2m



### Plastic endcaps

19.286 methacrylate frosted



### Methacrylate cover

18.040 frosted white 2m



### WARNING:

As this is not an extruded profile (manually folded profile) there are some tolerances in the final external measurements (mm). The dimensions therefore in this technical drawing are approximate.

# led profile by Luz Negra

## VISBY

Our PROFESSIONAL led profile series for surfaces and ceiling suspension is manufactured in white polycarbonate. The profile is ideal for surface applications, for example ceiling suspended luminaires, floor or wall mounted luminaires, and similar.

It is suitable for led strips with a maximum width of 15mm and a power not greater than 20W/m. In order to obtain a more homogeneous illumination, while also making the dots invisible, we recommend combining it with our Canovelles-Barcelona-Gomera-COB ecoled strips.

**We offer a 2 year guarantee.**

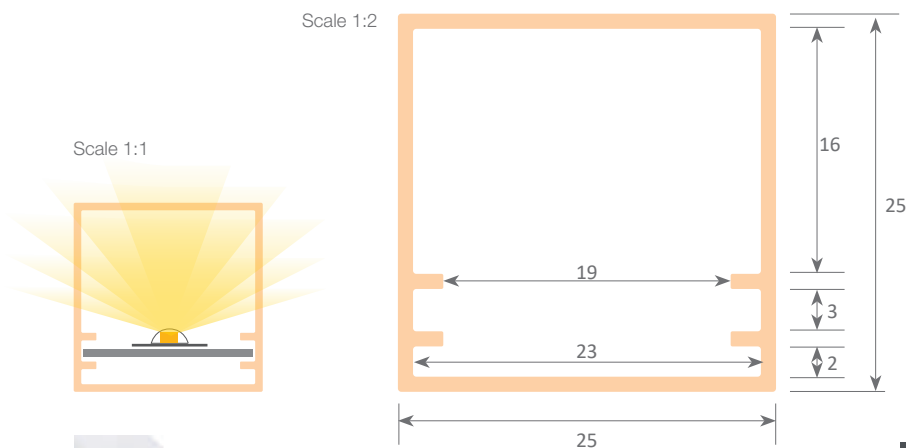

### Polycarbonate profile

02.031 opal white 3m



### Inner plate

22.014 aluminium 2m



### Endcaps

19.225 without hole

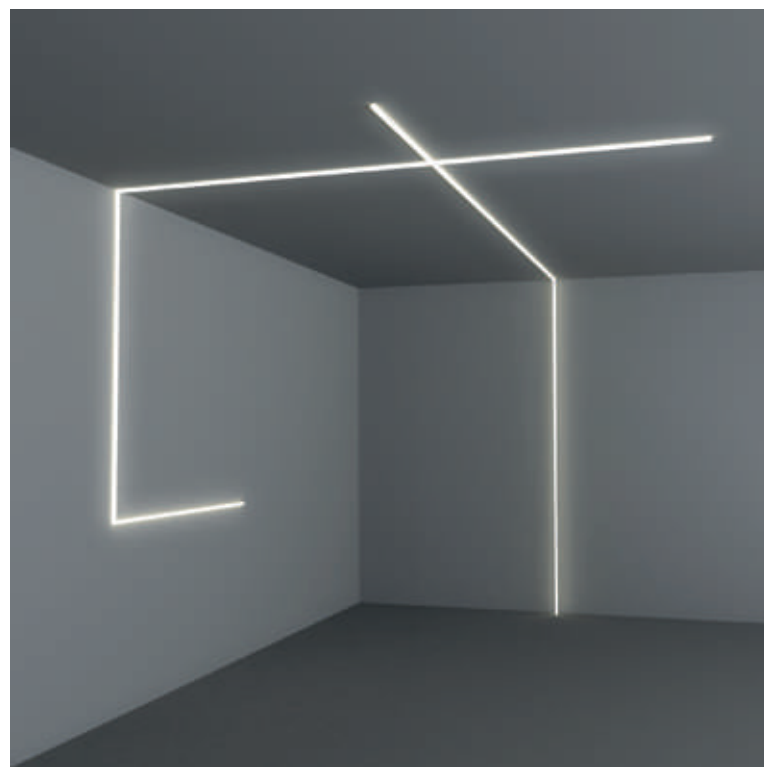

Aluminium alloy extrusion process in accordance with: ISO 9001:2008 - ISO 14001 / Tolerances defined by: UNE-EN 755-9 / UNE-EN 12020-2  
 Theoretical weight: 0.135kg / Alloy: 6063 / Perimeter: 100mm / Anodising minimum: 15 microns  
 Aluminium purity: 95-98% / Material treatment: T-5 / Covers: methacrylate (greater protection against UV rays)

# led profile by Luz Negra

## MONTERREY

Our led profile PROFESSIONAL series for surface is manufactured in 6 different colours of polycarbonate. The profile is suitable for perimetral illumination and can be used in facades, buildings or similar. It is compatible with led strips with a maximum thickness of 15mm and a power not greater than 20W/m. We recommend using it with our frosted cover and our ecoled strips Canovelles-Vizcaya-Cob IP67-Castellón RGB in order to achieve a more uniform and homogeneous illumination.

**We offer a 2 years guarantee.**

Scale 1:1

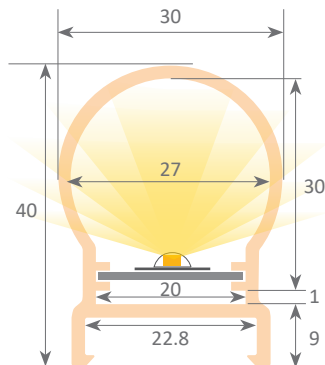

### Polycarbonate profile

08.023	yellow	118cm
08.024	orange	118cm
08.025	blue	236cm
08.026	red	236cm
08.027	green	236cm
08.028	white	236cm



### Plastic endcaps

19.278	yellow
19.279	orange
19.280	blue
19.281	red
19.282	green
19.283	white



### Junction

22.171	red
22.172	blue
22.173	white



### Internal corner

22.177	red
22.178	blue
22.179	white



### External corner

22.180	red
22.181	blue
22.182	white



### Inner plate

22.014	aluminium	2m
--------	-----------	----



### Clip

20.053	polycarbonate
--------	---------------



### Silicone rubber

22.068
--------



### Joint

22.174	red
22.175	Azul
22.176	white



Aluminium alloy extrusion process in accordance with: ISO 9001:2008 - ISO 14001 / Tolerances defined by: UNE-EN 755-9 / UNE-EN 12020-2  
Alloy: 6063 / Anodising minimum: 15 microns  
Aluminium purity: 95-98% / Material treatment: T-5 / Covers: methacrylate (greater protection against UV rays)



led profiles for recessing





BOSTON  
70



FRANKFURT  
71



PHILADELPHIA  
72



BERLIN  
73



BERLIN XL  
74



DALLAS  
76



PHILADELPHIA  
MINI  
78

Our BASIC led profile series for recessing is manufactured in high purity aluminium and available in anodised silver, lacquered white, lacquered black and raw aluminium (on demand, we can supply different anodised and lacquered finishings). Ideal for embedding in furniture, shelves and similar. Suitable for led strips with a maximum width of 14mm and a power not greater than 15W/m, as there is no ventilation when embedded in wooden surfaces. We recommend using it with our Canovelles-Barcelona-Gomera-COB ecoled strips.

**We offer a 2 year guarantee on our profiles and covers.**

Scale 1:1



### Aluminium profile

03.005	anodised silver	2m
03.006	white lacquered	2m
03.007	raw	2m
03.013	black lacquered	2m
03.008	anodised silver	6m
03.009	white lacquered	6m
03.010	raw	6m
03.012	black lacquered	6m

Scale 1:2

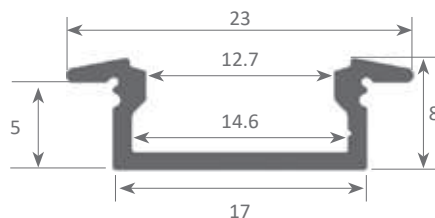

### Plastic endcaps

19.051	white with hole
19.052	white without hole
19.053	grey with hole
19.054	grey without hole
19.445	black with hole
19.446	black without hole

\* California's endcaps can also be used



### Clip

20.005	transparent plastic
--------	---------------------



### 90° angle bracket

22.001	steel (52x13mm)
--------	-----------------



### Polycarbonate cover

18.116	opal	2m
18.146	frosted	2m
18.148	opal	2m
18.018	opal	3m
18.115	opal	6m
18.145	frosted	2m
18.147	opal	2m



### Methacrylate cover

18.014	transparent	2m
18.015	frosted	2m
18.016	transparent	6m
18.017	frosted	6m



Aluminium alloy extrusion process in accordance with: ISO 9001:2008 - ISO 14001 / Tolerances defined by: UNE-EN 755-9 / UNE-EN 12020-2  
Theoretical weight: 0.127kg / Alloy: 6063 / Perimeter: 79mm / Anodising minimum: 15 microns  
Aluminium purity: 95-98% / Material treatment: T-5 / Covers: methacrylate (greater protection against UV rays)

# led profile by Luz Negra

Our PROFESSIONAL led profile series for recessing (only 7.5mm high) is manufactured in high purity aluminium silver, black anodised and textured white lacquered. Ideal for embedding in furniture, shelving and similar areas where we require a minimalist profile with very reduced dimensions.

Its "easy-ON" cover (available in 8 different finishings), when combined with this profile, provides an IP65 rating to the luminaire. Therefore, the profile can be used in places with high levels of humidity, for example bathrooms, kitchens, gyms, spas, cold storage chambers, fridges, and similar.

The profile and its covers are available in lengths of 2 and 6 metres, allowing us to carry out large projects where all the profiles do not have breaks. It is suitable for led strips with a maximum width of 12mm and a power not greater than 15W/m, as there is no ventilation when embedded in wooden surfaces. We recommend using it with our Canovelles-Barcelona-Gomera-COB ecoled strips.

**We offer a 10 year guarantee on the profiles and a 4 year guarantee on the covers.**

## FRANKFURT



IP65



Scale 1:1

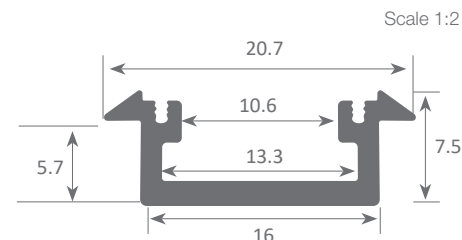
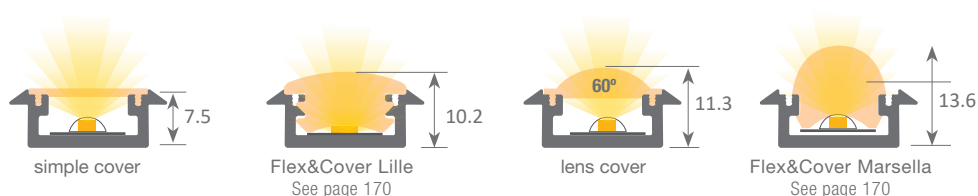

When applying the lens cover on the Frankfurt profile together with the flexible led strip we get a beam of 60° light.



### Aluminium profile

03.001	anodised silver	2m
03.002	anodised black	2m
03.015	white lacquered	2m
03.003	anodised silver	6m
03.004	anodised black	6m
03.014	white lacquered	6m



### Plastic endcaps

19.048	grey
19.049	black

\* Milano's endcaps can also be used



### Plastic endcaps

19.050	grey for lens
--------	---------------



### Clip

20.001	chrome steel
20.002	black oxide finish



### Polycarbonate cover "easy-ON"

18.001	transparent	2m
18.002	opal	2m
18.003	frosted	2m
18.004	transparent	6m
18.005	opal	6m
18.006	frosted	6m
18.134	frosted	60m

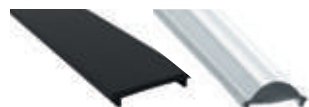

### Black&White cover "easy-ON"

18.007	Black&White	2m
18.008	opaque grey	2m
18.009	Black&White	6m

### Polycarbonate cover "easy-ON"

18.010	lens	2m
18.011	lens	6m

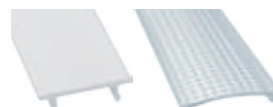

### Polycarbonate cover

18.140	frosted	2m
18.139	frosted	6m

\*Only for WHITE profile

### Polycarbonate cover "easy-ON"

18.135	microprism	2m
18.136	microprism	6m



### 90° angle bracket

22.001	steel (52x13mm)
--------	-----------------



Patente Europea  
Nº.: 13156605.1

Aluminium alloy extrusion process in accordance with: ISO 9001:2008 - ISO 14001 / Tolerances defined by: UNE-EN 755-9 / UNE-EN 12020-2  
Theoretical weight: 0.138kg / Alloy: 6063 / Perimeter: 77mm / Anodising minimum: 15 microns  
Aluminium purity: 95-98% / Material treatment: T-5 / Covers: Fireproof V0

Our BASIC led profile series for recessing is manufactured in high purity aluminium and available in anodised silver, lacquered white, lacquered black and raw aluminium (on demand, we can supply different anodised and lacquered finishings). Ideal for embedding in furniture, shelving and similar, where we require a profile with a dot free effect.

Suitable for led strips with a maximum width of 14mm and a power not greater than 16W/m. We recommend using it with our Canovelles-Barcelona-Gomera-COB ecoled strips.

**We offer a 2 year guarantee on our profiles and covers.**

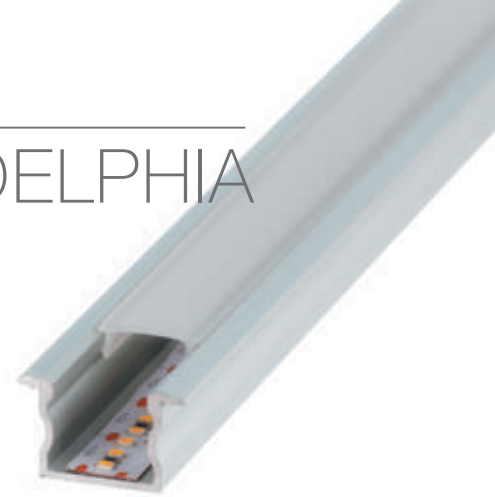

Scale 1:2

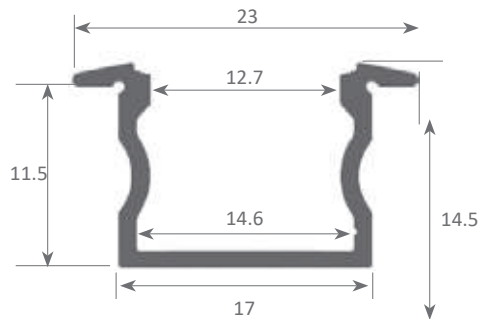

Scale 1:1



### Aluminium profile

04.009	anodised silver	2m
04.010	white lacquered	2m
04.011	raw	2m
04.021	black lacquered	2m
04.012	anodised silver	6m
04.013	white lacquered	6m
04.014	raw	6m
04.020	black lacquered	6m

### Plastic endcaps

19.061	white with hole
19.062	white without hole
19.063	grey with hole
19.064	grey without hole
19.443	black with hole
19.444	black without hole

### Clip

20.005	transparent plastic
--------	---------------------



### Polycarbonate cover

18.116	opal	2m
18.146	frosted	2m
18.148	opal	2m
18.018	opal	3m
18.115	opal	6m
18.145	frosted	2m
18.147	opal	2m



### Methacrylate cover

18.014	transparent	2m
18.015	frosted	2m
18.016	transparent	6m
18.017	frosted	6m



Aluminium alloy extrusion process in accordance with: ISO 9001:2008 - ISO 14001 / Tolerances defined by: UNE-EN 755-9 / UNE-EN 12020-2  
Theoretical weight: 0.176kg / Alloy: 6063 / Perimeter: 105mm / Anodising minimum: 15 microns  
Aluminium purity: 95-98% / Material treatment: T-5 / Covers: methacrylate (greater protection against UV rays)

# led profile by Luz Negra

Our PROFESSIONAL led profile series for recessing is manufactured in high purity anodised in silver, black and textured white lacquered. Ideal for embedding in furniture, shelving and similar areas where we require a profile with a dot free effect.

Its "easy-ON" cover (available in 8 different finishings), when combined with this profile, provides an IP65 rating to the luminaire. Therefore, the profile can be used in places with high levels of humidity, such as bathrooms, kitchens, gyms, spas, cold storage chambers, fridges, or similar.

This profile and its covers are available in lengths of 2 and 6 metres, allowing us to carry out large projects where all the profiles do not need breaks. It is suitable for led strips with a maximum width of 12mm and a power not greater than 15W/m, as there is no ventilation when embedded in wooden surfaces. We recommend using it with our Canovelles-Barcelona-Gomera-COB ecoled strips.

**We offer a 10 year guarantee on the profiles and a 4 year guarantee on the cover.**

## BERLIN



IP65



Scale 1:1

By applying the lens cover on the Berlin profile together with the flexible led strip we get a beam of 30° light.

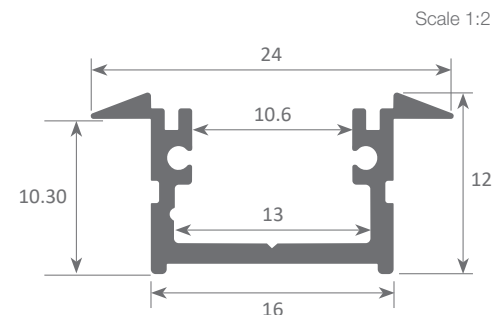
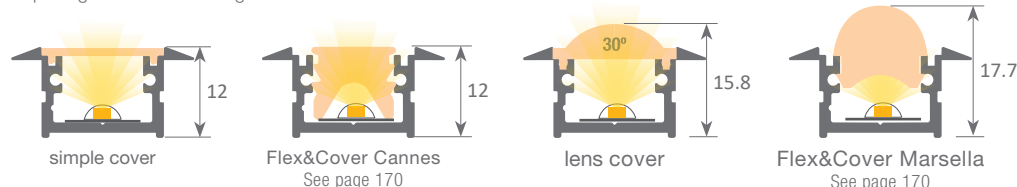

Scale 1:2



### Aluminium profile

04.001	anodised silver	2m
04.002	anodised black	2m
04.023	white lacquered	2m
04.003	anodised silver	6m
04.004	anodised black	6m
04.022	white lacquered	6m



### Plastic endcaps

19.055	grey without hole
19.456	grey with hole*
19.056	black without hole
19.457	black with hole
19.459	white without hole
19.458	white with hole

\*Roma endcaps can also be used



### Plastic endcaps

19.057	grey for lens
19.058	black for lens



### Polycarbonate cover "easy-ON"

18.001	transparent	2m
18.002	opal	2m
18.003	frosted	2m
18.004	transparent	6m
18.005	opal	6m
18.006	frosted	6m
18.134	frosted	60m

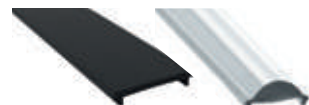

### Black&White cover "easy-ON"

18.007	Black&White	2m
18.008	opaque grey	2m
18.009	Black&White	6m

### Polycarbonate cover "easy-ON"

18.010	lens	2m
18.011	lens	6m

\*Only for WHITE profile

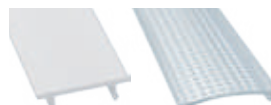

### Polycarbonate cover

18.140	frosted	2m
18.139	frosted	6m

### Polycarbonate cover "easy-ON"

18.135	microprism	2m
18.136	microprism	6m



Aluminium alloy extrusion process in accordance with: ISO 9001:2008 - ISO 14001 / Tolerances defined by: UNE-EN 755-9 / UNE-EN 12020-2  
Theoretical weight: 0.167kg / Alloy: 6063 / Perimeter: 108mm / Anodising minimum: 15 microns  
Aluminium purity: 95-98% / Material treatment: T-5 / Covers: Fireproof V0

Our PROFESSIONAL led profile series for recessing is manufactured in high purity aluminium and available in anodised silver, black and white lacquered. Ideal for embedding in furniture, shelving and similar areas where a width greater than the standard is required. This allows us to use wider led strips for an increased heat dissipation and a wider angle of light emission.

Its cover (available in 8 different finishings), when combined with this profile, provides an IP65 rating to the luminaire. Therefore, the profile can be used in places with high levels of humidity, such as bathrooms, kitchens, gyms, spas, cold storage chambers, fridges and similar.

This profile and its covers are available in lengths of 2 and 6 metres, allowing us to carry out large projects where all the profiles do not need breaks. It is suitable for led strips with a maximum width of 15mm and a power not greater than 15W/m, as there is no ventilation when embedded in wooden surfaces. We recommend using it with our Canovelles-Barcelona-Gomera-COB ecoled strips.

**We offer a 10 year guarantee on the profiles and a 4 year guarantee on the cover.**

## BERLIN XL



IP65



Scale 1:1

By applying the lens cover on the Berlin XL profile together with the flexible led strip we get a beam of 60° light. The information is just approximate. Please check with our technical department.

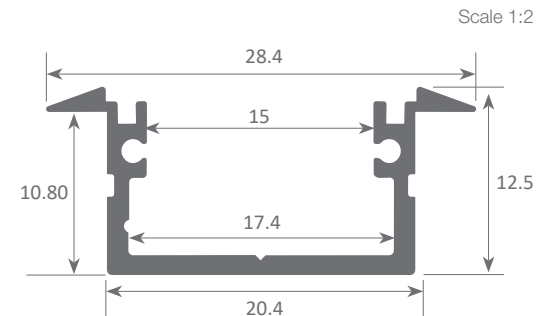
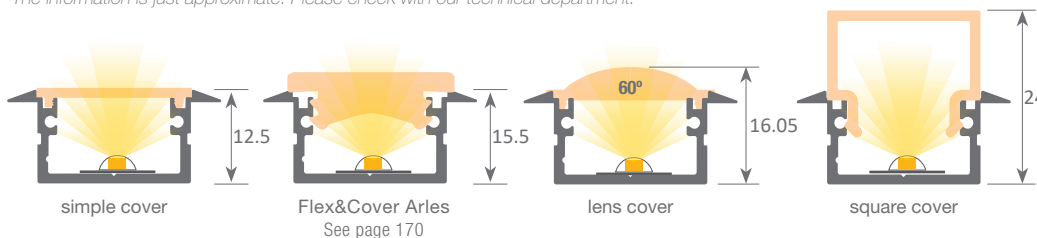

Scale 1:2



### Aluminium profile

04.005	anodised silver	2m
04.006	anodised black	2m
04.019	white lacquered	2m
04.007	anodised silver	6m
04.008	anodised black	6m
04.018	white lacquered	6m



### Plastic endcaps

19.059	grey without hole*
19.060	grey with hole*
19.320	black with hole
19.321	black without hole
19.355	white with hole
19.354	white without hole

\*Roma XL endcaps can also be used



### Clip

20.009	chrome steel
20.010	black oxide finish



### 90° angle bracket

22.001	steel (52x13mm)
--------	-----------------



### Polycarbonate cover "easy-ON"

18.022	transparent	2m
18.023	opal	2m
18.024	frosted	2m
18.030	lens	2m
18.025	transparent	6m
18.026	opal	6m
18.027	frosted	6m
18.031	lens	6m

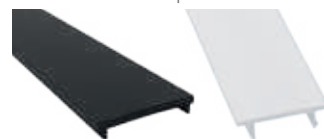

### Black&White cover "easy-ON"

18.028	Black&White	2m
18.029	Black&White	6m

### Polycarbonate cover

18.127	frosted	2m
18.126	frosted	6m

\*Only for WHITE XL profile

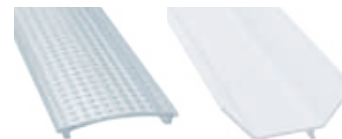

### Polycarbonate cover "easy-ON"

18.130	microprism	2m
18.129	microprism	6m

### Polycarbonate cover with side wings

18.132	frosted	2m
18.131	frosted	6m



### Square cover

18.032	frosted	2m
18.102	Black&White	2m
18.033	frosted	6m
18.034	Black&White	6m



Patente Europea  
Nº.: 13156605.1

Aluminium alloy extrusion process in accordance with: ISO 9001:2008 - ISO 14001 / Tolerances defined by: UNE-EN 755-9 / UNE-EN 12020-2  
Theoretical weight: 0.187kg / Alloy: 6063 / Perimeter: 120mm / Anodising minimum: 15 microns  
Aluminium purity: 95-98% / Material treatment: T-5 / Covers: Fireproof V0



# led profile by Luz Negra

## DALLAS

Our PROFESSIONAL led profile series for recessing and is only 6mm wide (with side wings 12mm). Manufactured in high purity aluminium and available in anodised silver, it stands out for being the thinnest solution for recessing and offers a visible light of only 2.5mm wide.

Mainly used for recessing in furniture, shelving and display units, where the line of light must be extremely thin.

It is an elegant and unique design only suitable for very thin side light led strips and we therefore recommend combining it with our Getafe ecoled strip.

**We offer a 2 year guarantee on our profiles and covers.**

Scale 1:1



Scale 1:2

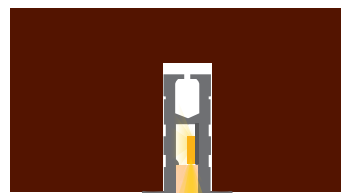
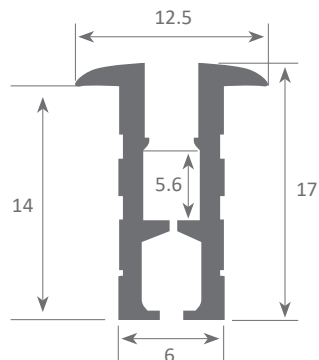

### Aluminium profile (set of 2)

03.011 anodised silver 2m



### Methacrylate cover

18.041 opal 1m

(for easy installation we recommend fixing the cover with double-sided tape).



Aluminium alloy extrusion process in accordance with: ISO 9001:2008 - ISO 14001 / Tolerances defined by: UNE-EN 755-9 / UNE-EN 12020-2  
Theoretical weight: 0.099 + 0.102kg / Alloy: 6063 / Perimeter: 49 + 51mm / Anodising minimum: 15 microns  
Aluminium purity: 95-98% / Material treatment: T-5 / Covers: methacrylate (greater protection against UV rays)



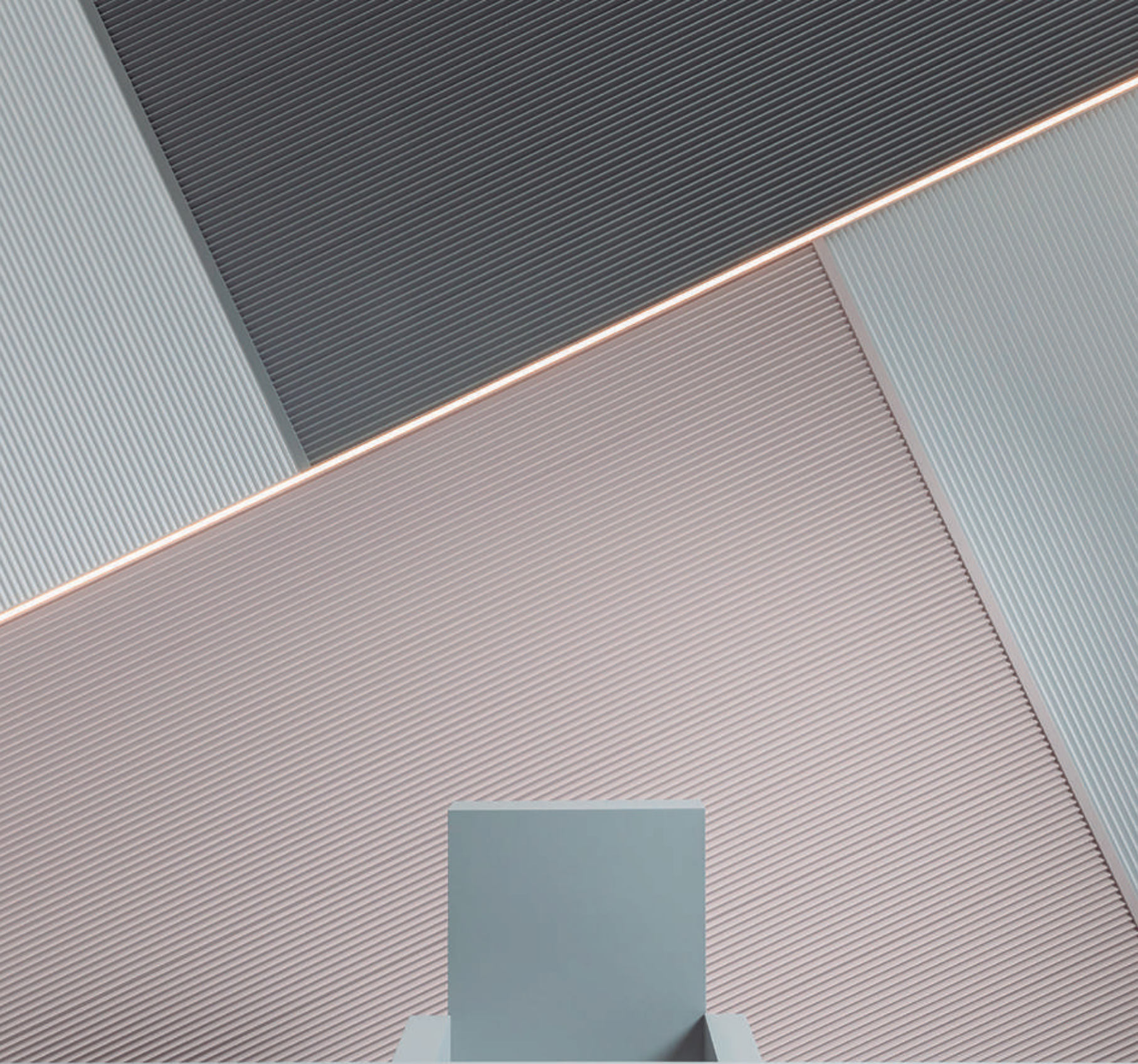

# led profile by Luz Negra

Our BASIC led profile series for recessing is manufactured in high purity aluminium and available in anodised silver and black aluminium (on demand, we can supply different anodised and lacquered finishings). Ideal for embedding in furniture, shelving and similar, where we require a profile with a dot free effect.

Suitable for led strips with a maximum width of 5mm and a power not greater than 15W/m. We recommend using it with our Cíes ecoled strips.

**We offer a 2 year guarantee on our profiles and covers.**

## PHILADELPHIA MINI



Scale 1:1



Scale 1:2

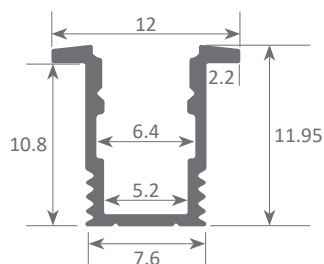

### Aluminium profile

04.015 anodised silver 3m  
04.016 anodised black 3m



### Plastic endcaps

19.217 with hole  
19.218 without hole  
19.289 black with hole  
19.290 black without hole



### Clip

20.050 chrome steel



### Polycarbonate cover

18.081 frosted 3m



### Black&White cover

18.085 Black&White 3m

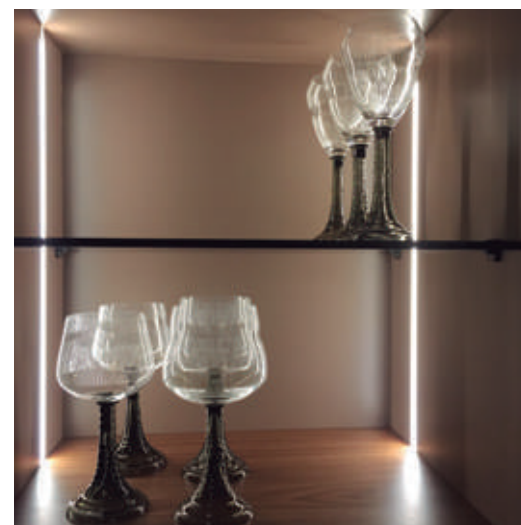

Patente Europea  
Nº.: 13156605.1

Aluminium alloy extrusion process in accordance with: ISO 9001:2008 - ISO 14001 / Tolerances defined by: UNE-EN 755-9 / UNE-EN 12020-2  
Alloy: 6063 / Anodising minimum: 15 microns  
Aluminium purity: 95-98% / Material treatment: T-5 / Covers: Fireproof V0

# The difference is in the small details: small is big!!



In our catalogue you will find our new range of small, yet elegant profiles, perfect for a modern, minimalistic lighting. At Luz Negra we cover for all sizes. Meet the smaller members of our led profile family.

- Much more than small.
- Small, but by no means insignificant.
- Small profile, big inspiration.
- Small, simple yet seductive.
- The power of small.
- Minimalist elegance.



DETROIT See page 62



NEW YORK MINI See page 64



PHILADELPHIA MINI See page 78



NEON MICRO See page 176



NEON CUADRADO See page 178



NEON REDONDO See page 180



TEXAS MINI See page 88



DALLAS See page 76



CHICAGO See page 58

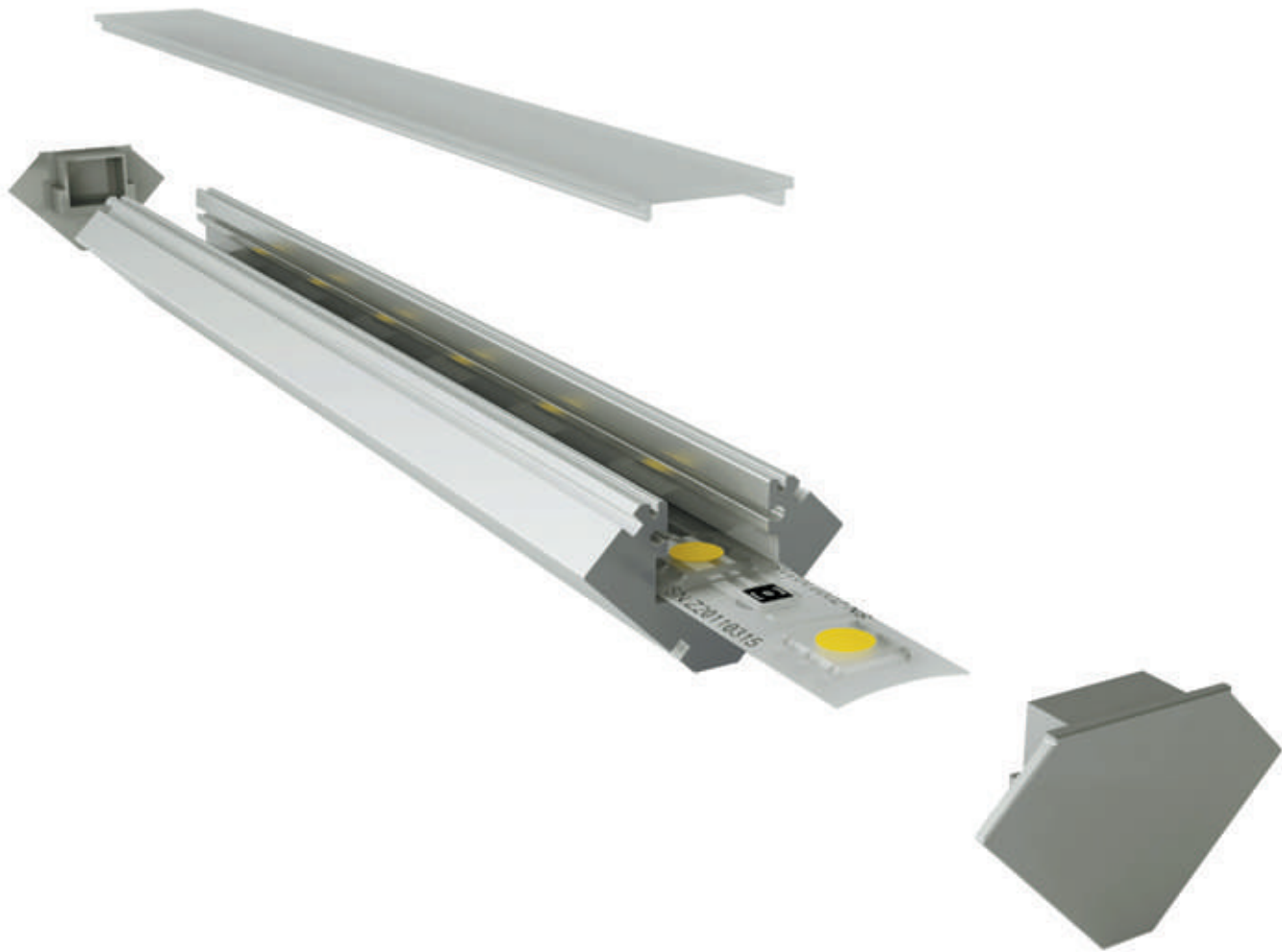

angular led profiles



82 TEXAS



83 SOPHIA



84 SOPHIA XL



86 AMSTERDAM

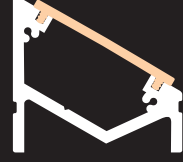

87 SOPHIA XL  
ASYMMETRIC



88 TEXAS MINI



90 ZAGREB



91 SPLIT



91A AMSTERDAM  
MINI

Our BASIC led profile series for angles is high purity aluminium and available in anodised silver, lacquered white and raw aluminium (on demand, we can supply different anodised and lacquered finishings). Ideal for wall surfaces, furniture, shelving and similar areas where we require an angular and continuous light emission along with an optimum heat dissipation.

Suitable for led strips with a maximum width of 12mm and a power not greater than 30W/m.

In order to obtain a more homogeneous illumination, while also a dot free effect, we recommend the combined use of both our frosted covers and Canovelles-Barcelona-Gomera ecoled strips.

**We offer a 2 year guarantee on our profiles and covers.**



Scale 1:1



Scale 1:2

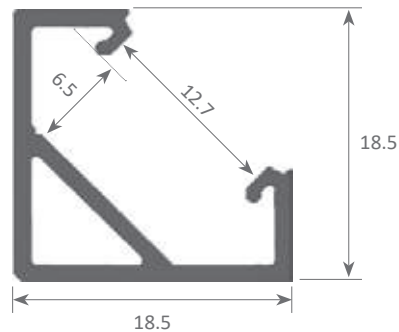

### Aluminium profile

05.015	anodised silver	2m
05.016	white lacquered	2m
05.017	raw	2m
05.018	anodised silver	6m
05.019	white lacquered	6m
05.020	raw	6m



### Plastic endcaps

19.073	white with hole
19.074	white without hole
19.075	grey with hole
19.076	grey without hole



### Clip

20.017	transparent plastic
--------	---------------------



### Adjustable bracket

20.004	chrome steel (clip not included)
--------	-------------------------------------



### Polycarbonate cover

18.116	opal	2m
18.146	frosted	2m
18.148	opal	2m
18.018	opal	3m
18.115	opal	6m
18.145	frosted	2m
18.147	opal	2m



### Methacrylate cover

18.014	transparent	2m
18.015	frosted	2m
18.016	transparent	6m
18.017	frosted	6m



Aluminium alloy extrusion process in accordance with: ISO 9001:2008 - ISO 14001 / Tolerances defined by: UNE-EN 755-9 / UNE-EN 12020-2  
Theoretical weight: 0.213kg / Alloy: 6063 / Perimeter: 128mm / Anodising minimum: 15 microns  
Aluminium purity: 95-98% / Material treatment: T-5 / Covers: methacrylate (greater protection against UV rays)

# led profile by Luz Negra

## SOPHIA



IP65



Our PROFESSIONAL led profile series for corners is manufactured in high purity anodised in silver, black and textured white lacquered. Ideal for wall surfaces, furniture, shelving and similar areas where we require an angled and continuous light emission along with optimum heat dissipation.

Its "easy-ON" cover (available in 8 different finishings), when combined with this profile, provides an IP65 rating to the luminaire. Therefore, the profile can be used in places with high levels of humidity, such as bathrooms, kitchens, gyms, spas, cold storage chambers, fridges, or others.

The profile and its covers are available in lengths of 2 and 6 metres, allowing us to carry out large projects where all the profiles do not need breaks. It is suitable for led strips with a maximum width of 13mm and a power not greater than 30W/m.

In order to obtain a more homogeneous and diffused illumination, we recommend the combined use of both our opal covers and Canovelles-Barcelona-Gomera-Cies ecoled strips.

**We offer a 10 year guarantee on the profiles and a 4 year guarantee on the cover.**

Scale 1:1

When applying the lens cover on the Sophia profile together with the flexible led strip we get a beam of 25° light.

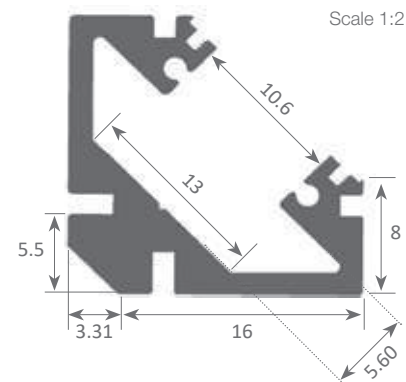
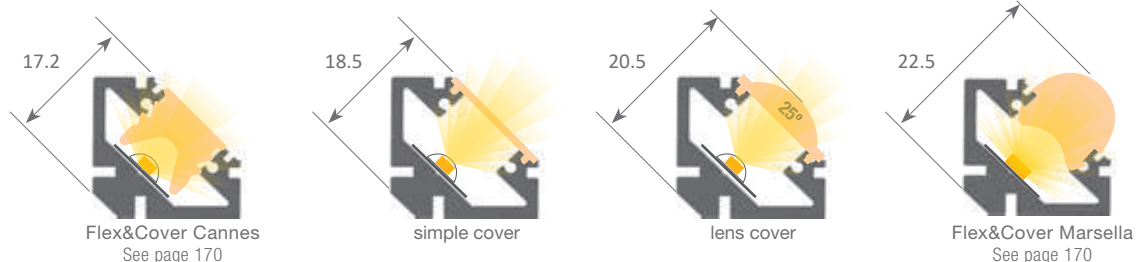

### Aluminium profile

05.001	anodised silver	2m
05.002	anodised black	2m
05.030	white lacquered	2m
05.004	anodised silver	6m
05.005	anodised black	6m
05.029	white lacquered	6m



### Plastic endcaps

19.065	grey without hole
19.066	grey with hole
19.067	black without hole
19.068	black with hole
19.451	white with hole
19.452	white without hole



### Plastic endcaps

19.069	grey without hole lens
19.070	grey with hole lens



### Hanging KIT

21.001	chrome	set of 2 units
21.002	white	set of 2 units
21.003	black	set of 2 units (clip not included)



### Polycarbonate cover "easy-ON"

18.001	transparent	2m
18.002	opal	2m
18.003	frosted	2m
18.004	transparent	6m
18.005	opal	6m
18.006	frosted	6m
18.134	frosted	60m



### Black&White cover "easy-ON"

18.007	Black&White	2m
18.008	opaque grey	2m
18.009	Black&White	6m

### Polycarbonate cover "easy-ON"

18.010	lens	2m
18.011	lens	6m

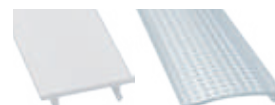

### Polycarbonate cover

18.140	frosted	2m
18.139	frosted	6m
*Only for WHITE profile		



### Clip

20.015	chrome steel
20.016	black oxide finish



Patente Europea  
Nº.: 13156605.1

Aluminium alloy extrusion process in accordance with: ISO 9001:2008 - ISO 14001 Tolerances defined by: UNE-EN 755-9 / UNE-EN 12020-2 / Theoretical weight: 0.338kg / Alloy: 6063 / Perimeter: 137mm / Anodising minimum: 15 microns / Aluminium purity: 95-98% / Material treatment: T-5 / Covers: Fireproof V0

# led profile by Luz Negra

Our PROFESSIONAL led profile series for angles is manufactured in high purity aluminium and available in anodised silver, black and white lacquered. Ideal for wall surfaces, shelving and similar areas where a width greater than the standard is required. This allows us to use wider led strips for an increased heat dissipation and a wider angle of light emission.

Its "easy-ON" cover (available in 6 different finishings), when combined with this profile, provides an IP65 rating to the luminaire. Therefore, the profile can be used in places with high levels of humidity, such as bathrooms, kitchens, gyms, spas, cold storage chambers, fridges, or others.

This profile and its covers are available in lengths of 2 and 6 metres, allowing us to carry out large projects where all the profiles do not need breaks. It is suitable for led strips with a maximum width of 15mm and a power not greater than 35W/m. In order to obtain a more homogeneous and diffused illumination, we recommend the combined use of both our opal covers and Canovelles-Barcelona-Gomera-COB ecoled strips.

**We offer a 10 year guarantee on the profiles and a 4 year guarantee on the covers.**

Scale 1:1

By applying the lens cover on the Sophia XL profile together with the flexible led strip we get a beam of 40° light. The information is just approximate. Please check with our technical department.

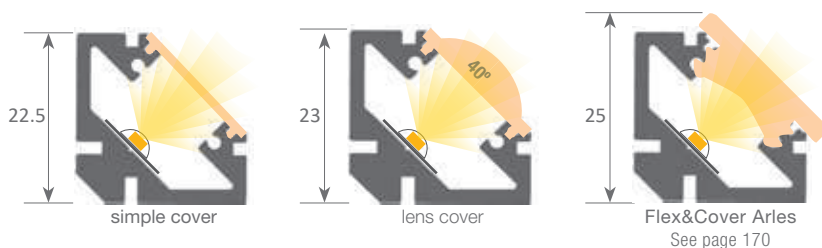

## Aluminium profile

05.011	anodised silver	2m
05.012	anodised black	2m
05.026	white lacquered	2m
05.013	anodised silver	6m
05.014	anodised black	6m
05.025	white lacquered	6m

## Plastic endcaps

19.071	grey without hole
19.072	grey with hole
19.294	black with hole
19.295	black without hole
19.430	white without hole
19.431	white with hole



## Polycarbonate cover "easy-ON"

18.022	transparent	2m
18.023	opal	2m
18.024	frosted	2m
18.030	lens	2m
18.025	transparent	6m
18.026	opal	6m
18.027	frosted	6m
18.031	lens	6m



## Black&White cover "easy-ON"

18.028	Black&White	2m
18.029	Black&White	6m

## Polycarbonate cover

18.127	frosted	2m
18.126	frosted	6m

\*Only for WHITE XL profile

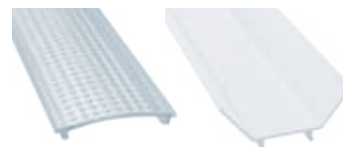

## Polycarbonate cover "easy-ON"

18.130	microprism	2m
18.129	microprism	6m

## Polycarbonate cover with side wings

18.132	frosted	2m
18.131	frosted	6m

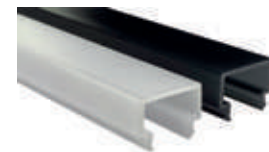

## Square cover

18.032	frosted	2m
18.102	Black&White	2m
18.033	frosted	6m
18.034	Black&White	6m

# SOPHIA XL



IP65

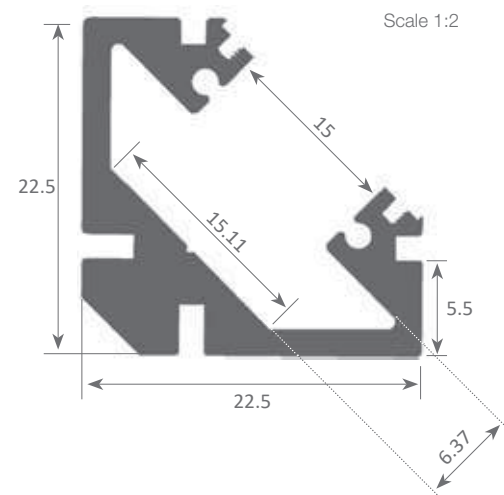

Scale 1:2



Patente Europea  
Nº.: 13156605.1

Aluminium alloy extrusion process in accordance with: ISO 9001:2008 - ISO 14001 / Tolerances defined by: UNE-EN 755-9 / UNE-EN 12020-2  
Theoretical weight: 0.430kg / Alloy: 6063 / Perimeter: 146mm / Anodising minimum: 15 microns  
Aluminium purity: 95-98% / Material treatment: T-5 / Covers: Fireproof V0



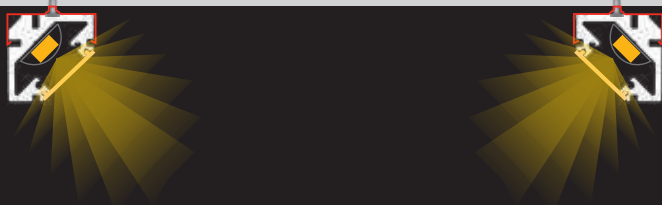

SOPHIA profile  
+ embedding clip "20.012"



SOPHIA profile  
+ hanging KIT "21.001"



**Clip**

- 20.012 chrome steel
- 20.013 black oxide finish



**Hanging KIT**

- 21.001 chrome set of 2 units
- 21.002 white set of 2 units
- 21.003 black set of 2 units  
(clip not included)

# led profile by Luz Negra

## AMSTERDAM

Our BASIC led profile series for angles is manufactured in high purity aluminium and available in anodized silver. Ideal for wall surfaces, furniture, shelving and similar areas where we require an angular and continuous light emission along with an optimum heat dissipation.

Suitable for led strips with a maximum width of 13.9mm and a power not greater than 20W/m.

In order to obtain a more homogeneous illumination, while also making the dots invisible, we recommend the combined use of both our frosted covers and Vizcaya-Topacio-COB ecoled strips.

**We offer a 2 year guarantee on our profiles and covers.**



Scale 1:1

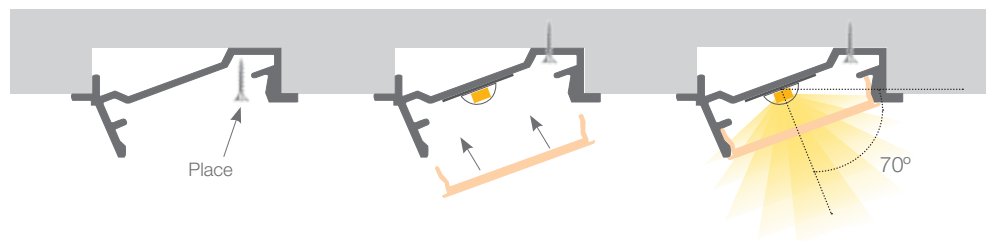
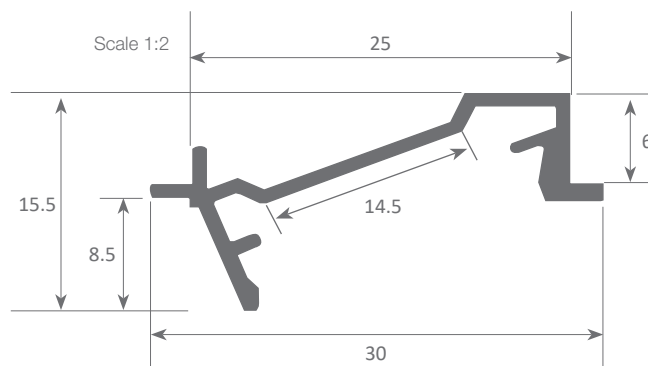
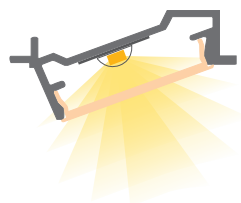

### Aluminium profile

05.023 anodised silver 3m



### Polycarbonate cover

18.044 opal 3m



### Plastic endcaps

19.081 grey without hole  
19.082 grey with hole



Aluminium alloy extrusion process in accordance with: ISO 9001:2008 - GB/T19001-2008 / Tolerances defined by:  $\pm 0.2\text{mm}$   
Theoretical weight: 0.138kg/m / Alloy: 6063 / Perimeter: 107.6303mm / Anodising minimum: 8-10 microns  
Aluminium purity: 97-99% / Material treatment: T-5 / Covers: Fireproof V0

Our PROFESSIONAL led profile series for angles is manufactured in high purity aluminium and silver anodised. Ideal for wall surfaces, shelving and similar areas where a width greater than the standard is required. This allows us to use wider led strips for an increased heat dissipation and a wider angle of light emission.

Its "easy-ON" cover (available in 6 different finishings), when combined with this profile, provides an IP65 rating to the luminaire. Therefore, the profile can be used in places with high levels of humidity, such as bathrooms, kitchens, gyms, spas, cold storage chambers, fridges, or others.

This profile and its covers are available in lengths of 2 and 6 metres, allowing us to carry out large projects where all the profiles do not need breaks. It is suitable for led strips with a maximum width of 12mm and a power not greater than 35W/m. In order to obtain a more homogeneous and diffused illumination, we recommend the combined use of both our opal covers and Canovelles-Barcelona-Gomera-COB ecoled strips.

**We offer a 10 year guarantee on the profiles and a 4 year guarantee on the covers.**

## SOPHIA XL ASYMMETRIC



IP65

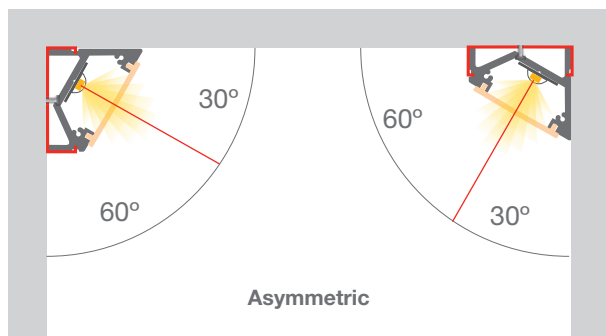

Scale 1:2

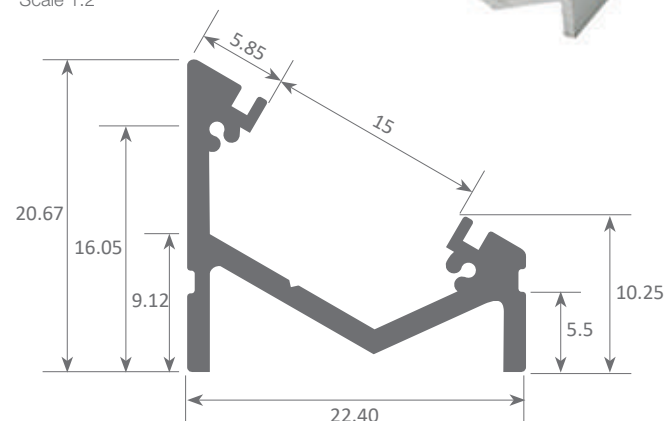

Scale 1:1

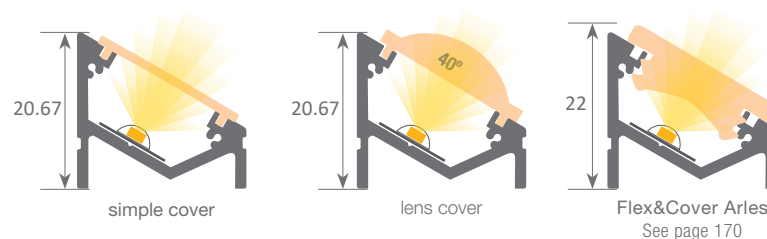

### Aluminium profile

05.007	anodised silver	2m
05.008	anodised black	2m
05.009	anodised silver	6m
05.010	anodised black	6m



### Plastic endcaps

19.210	grey left endcap
19.211	grey right endcap
19.315	black right endcap
19.316	black left endcap



### Polycarbonate cover "easy-ON"

18.022	transparent	2m
18.023	opal	2m
18.024	frosted	2m
18.030	lens	2m
18.025	transparent	6m
18.026	opal	6m
18.027	frosted	6m
18.031	lens	6m



### Square cover

18.032	frosted	2m
18.102	Black&White	2m
18.033	frosted	6m
18.034	Black&White	6m

### Polycarbonate cover

18.127	frosted	2m
18.126	frosted	6m

\*Only for WHITE XL profile

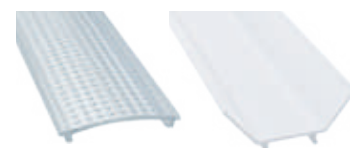

### Polycarbonate cover "easy-ON"

18.130	microprism	2m
18.129	microprism	6m

### Black&White cover "easy-ON"

18.028	Black&White	2m
18.029	Black&White	6m

### Polycarbonate cover with side wings

18.132	frosted	2m
18.131	frosted	6m



### Clip

20.012	chrome steel
20.013	black oxide finish



Patente Europea  
Nº.: 13156605.1

Aluminium alloy extrusion process in accordance with: ISO 9001:2008 - ISO 14001 / Tolerances defined by: UNE-EN 755-9 / UNE-EN 12020-2  
Theoretical weight: 0.251kg / Alloy: 6063 / Perimeter: 122mm / Anodising minimum: 15 microns  
Aluminium purity: 95-98% / Material treatment: T-5 / Covers: Fireproof V0

# led profile by Luz Negra

Our BASIC led profile series for angles is manufactured in high purity aluminium and available in anodised silver (on demand, we can supply different anodised and lacquered finishings). Ideal for wall surfaces, furniture, shelving and similar areas where we require an angular and continuous light emission along with an optimum heat dissipation.

Suitable for led strips with a maximum width of 5mm and a power not greater than 15W/m.

In order to obtain a more homogeneous illumination, while also a dot free effect, we recommend the combined use of both our frosted covers and Cies ecoled strips.

**We offer a 2 year guarantee on our profiles and covers.**

## TEXAS MINI



Scale 1:1



Scale 1:2

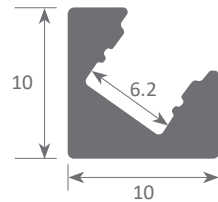

### Aluminium profile

05.024 anodised silver 2m



### Plastic endcaps

19.219 with hole  
19.220 without hole



### Polycarbonate cover

18.086 frosted 2m



### Clip

20.051 anodised silver

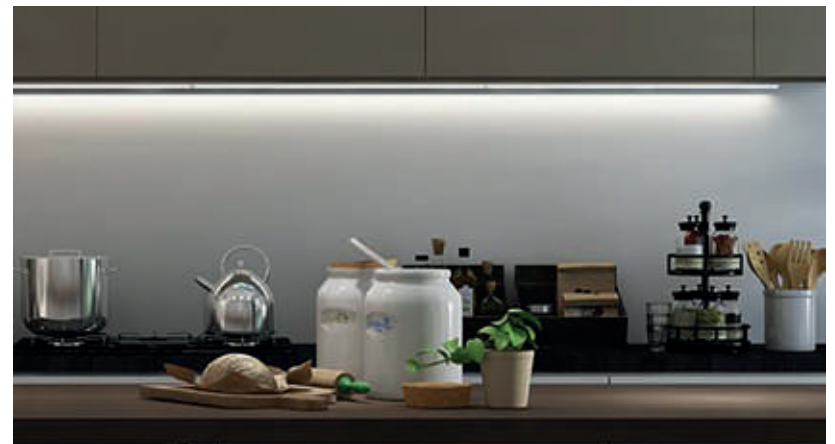

Aluminium alloy extrusion process in accordance with: ISO 9001:2008 - ISO 14001 / Tolerances defined by: UNE-EN 755-9 / UNE-EN 12020-2  
Alloy: 6063 / Anodising minimum: 15 microns  
Aluminium purity: 95-98% / Material treatment: T-5 / Covers: methacrylate (greater protection against UV rays)



# led profile by Luz Negra

Our BASIC led profile series for angles is manufactured in high purity aluminium and available in anodised silver. Ideal for wall surfaces, furniture, shelving and similar areas where we require an angular and continuous light emission along with an optimum heat dissipation.

Suitable for led strips with a maximum width of 10mm and a power not greater than 20W/m.

In order to obtain a more homogeneous illumination, while also a dot free effect, we recommend the combined use of both our frosted covers and Vizcaya-Topacio-Cíes ecoled strips.

**We offer a 2 year guarantee on our profiles and covers.**

## ZAGREB



Scale 1:1



Scale 1:2

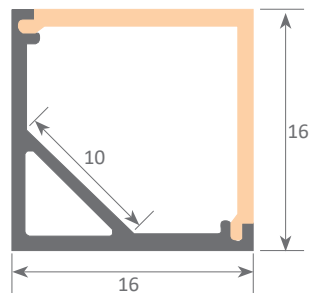

### Aluminium profile

05.021 anodised silver 3m



### Plastic endcaps

19.077 grey with hole  
19.078 grey without hole



### Polycarbonate cover

18.042 opal 3m



### Clip

20.018 plastic



Aluminium alloy extrusion process in accordance with: ISO 9001:2008 - GB/T19001-2008 / Tolerances defined by:  $\pm 0.2\text{mm}$   
Theoretical weight: 0.108kg/m / Alloy: 6063 / Perimeter: 65.7445mm / Anodising minimum: 8-10 microns  
Aluminium purity: 97-99% / Material treatment: T-5 / Covers: Fireproof V0

# led profile by Luz Negra

## SPLIT

Our BASIC led profile series for angles is manufactured in high purity aluminium and available in anodised silver aluminium. Ideal for wall surfaces, furniture, shelving and similar areas where we require an angular and continuous light emission along with an optimum heat dissipation.

Suitable for led strips with a maximum width of 10mm and a power not greater than 20W/m.

In order to obtain a more homogeneous illumination, while also a dot - free effect, we recommend the combined use of both our opal covers and Élite ecoled strips.

**We offer a 2 year guarantee on our profiles and covers.**



Scale 1:1



Scale 1:2

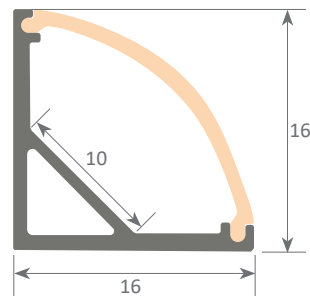

### Aluminium profile

05.021 anodised silver 3m



### Plastic endcaps

19.079 grey with hole  
19.080 grey without hole

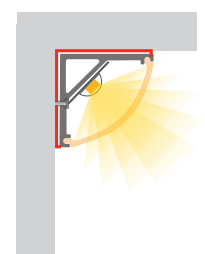
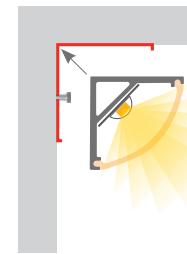
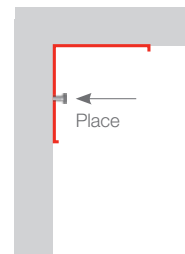

### Polycarbonate cover

18.043 opal 3m



### Clip

20.018 plastic



Aluminium alloy extrusion process in accordance with: ISO 9001:2008 - GB/T19001-2008 / Tolerances defined by:  $\pm 0.2\text{mm}$   
Theoretical weight: 0.108kg/m / Alloy: 6063 / Perimeter: 65.7445mm / Anodising minimum: 8-10 microns  
Aluminium purity: 97-99% / Material treatment: T-5 / Covers: Fireproof V0

# led profile by Luz Negra

Our PROFESSIONAL led profile series for angles is manufactured in high purity aluminium and available in silver anodised or black anodised.

Ideal for surface applications, walls, furniture, shelving and similar areas where we require an angular profile which can give out light at an angle. This helps to give a dot-free effect along with optimum heat dissipation. Suitable for led strips with a maximum width of 5mm and a power not greater than 12W/m. We recommend using with our COB ecoled strips to achieve a more homogeneous and diffused illumination.

**We offer a 2 year guarantee on our profiles and covers.**

## AMSTERDAM MINI

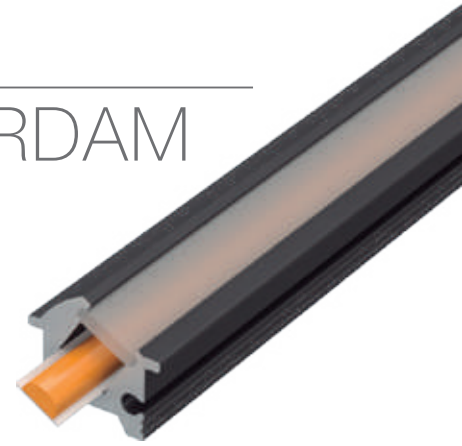

Scale 1:1



Scale 1:2

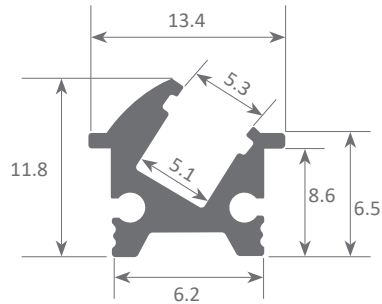

### Aluminium profile

05.027 silver anodised 1m  
05.028 black anodised 1m



### Plastic endcaps

19.435 black without hole (right)  
19.436 black without hole (left)  
19.437 grey without hole (right)  
19.438 grey without hole (left)



### Polycarbonate cover

18.014 frosted 1m



### Clip

20.017 aluminium





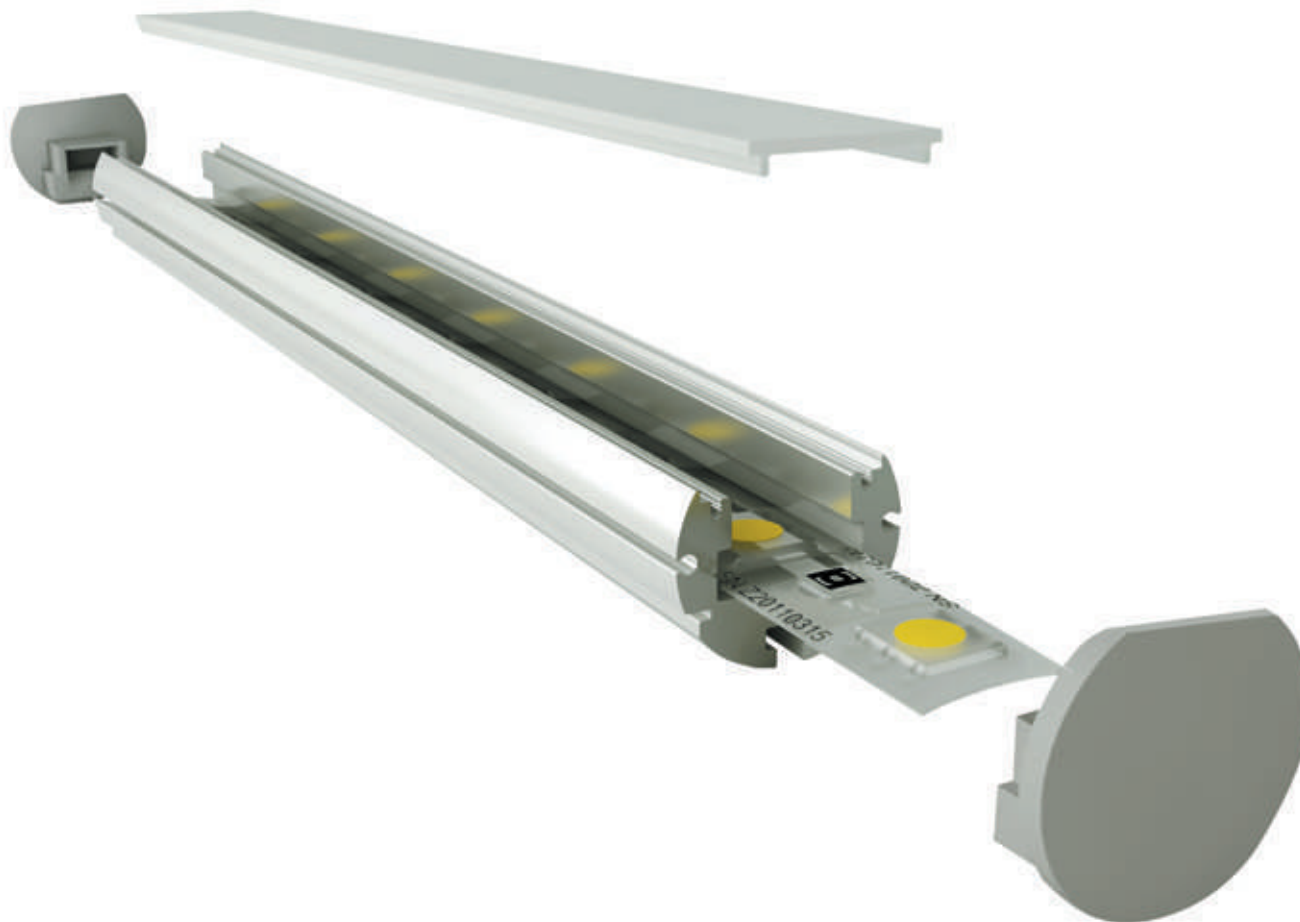

circular led profiles



PARIS

94



MIAMI

98

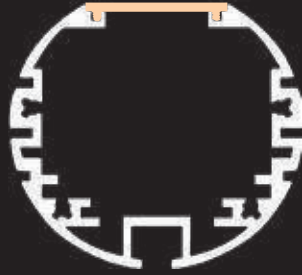

PARIS XL

100



OSLO  
B&W

102

OSLO

103

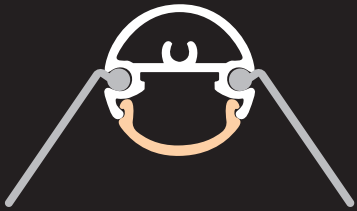

VIENA

103A



OSLO  
MINI

103B

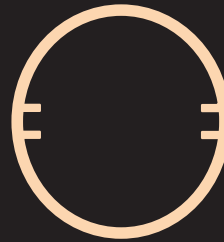

OSLO  
DOBLE

103C



OSLO 40

103D

# led profile by Luz Negra

Our PROFESSIONAL led profile series for surfaces and ceiling suspension is manufactured in high purity anodised aluminium and available in 3 different colours. The profile has a wide range of applications, examples of which include ceiling suspended luminaires, luminaires for displaying paintings, wardrobe garment rails, floor or wall mounted luminaires, and others.

Its "easy-ON" cover (available in 8 different finishings), when combined with this profile, provides an IP65 rating to the luminaire. Therefore, the profile can be used in places with high levels of humidity, for example bathrooms, kitchens, gyms, spas, cold storage chambers, fridges and others.

This profile and its covers are available in lengths of 2 and 6 metres, allowing us to carry out large projects where all the profiles do not need joints. It is suitable for led strips with a maximum width of 12mm and a power not greater than 30W/m. In order to obtain a more homogeneous and diffused illumination, we recommend the combined use of both our opal diffusers and Canovelles-Barcelona-Gomera-COB ecoled strips.

**We offer a 10 year guarantee on the profiles and a 4 year guarantee on the covers.**

Scale 1:1

When applying the lens cover on the Paris profile together with the flexible led strip we get a beam of 35° light.

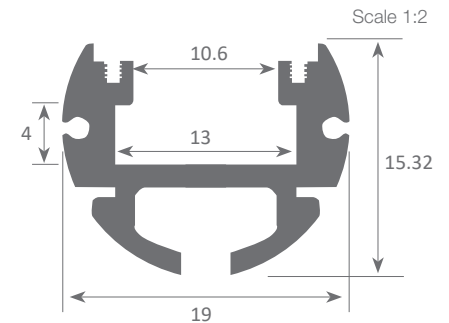
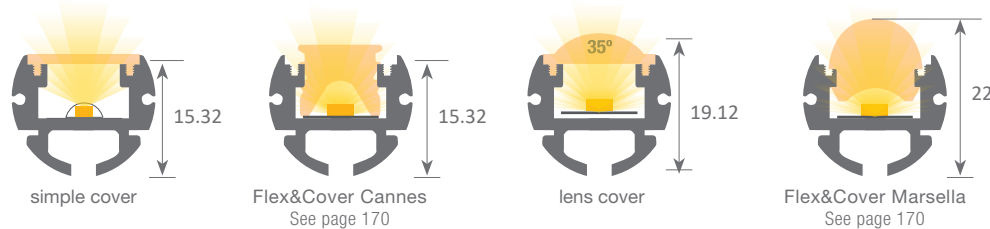

## PARIS



IP65



### Aluminium profile

13.001	anodised silver	2m
13.002	anodised black	2m
13.004	anodised silver	6m
13.005	anodised black	6m



### Plastic endcaps

19.083	grey without hole
19.084	grey with hole
19.085	black without hole
19.086	black with hole



### Plastic endcaps

19.087	grey without hole lens
19.088	grey with hole lens
19.089	black without hole lens
19.090	black with hole lens



### Polycarbonate cover "easy-ON"

18.001	transparent	2m
18.002	opal	2m
18.003	frosted	2m
18.004	transparent	6m
18.005	opal	6m
18.006	frosted	6m
18.134	frosted	60m

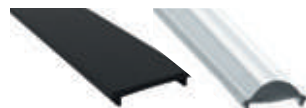

### Black&White cover "easy-ON"

18.007	Black&White	2m
18.008	opaque grey	2m
18.009	Black&White	6m

### Polycarbonate cover "easy-ON"

18.010	lens	2m
18.011	lens	6m



### Polycarbonate cover

18.140	frosted	2m
18.139	frosted	6m

\*Only for WHITE profile

### Polycarbonate cover "easy-ON"

18.135	microprism	2m
18.136	microprism	6m



Patente Europea  
Nº.: 13156605.1

Aluminium alloy extrusion process in accordance with: ISO 9001:2008 - ISO 14001 / Tolerances defined by: UNE-EN 755-9 / UNE-EN 12020-2  
Theoretical weight: 0.273kg / Alloy: 6063 / Perimeter: 121mm / Anodising minimum: 15 microns  
Aluminium purity: 95-98% / Material treatment: T-5 / Covers: Fireproof V0

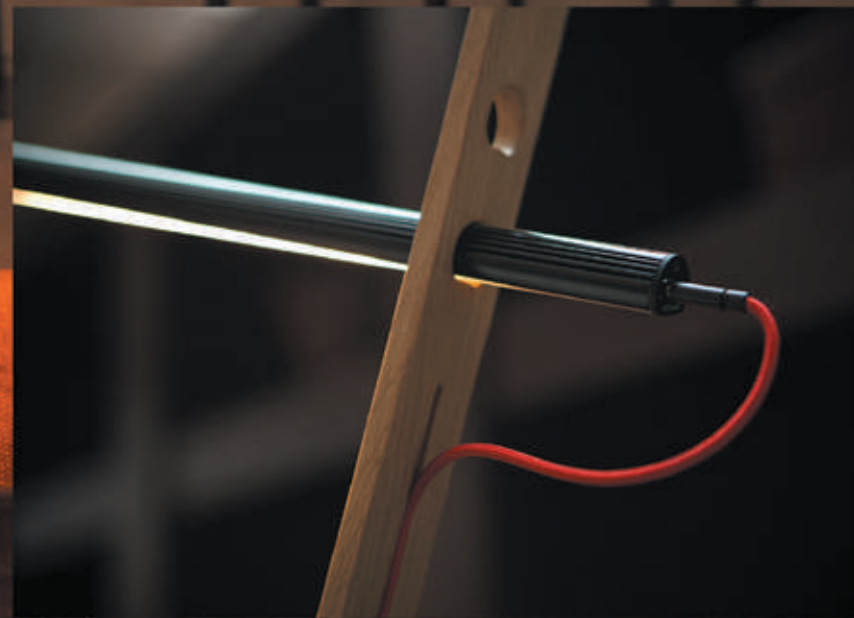

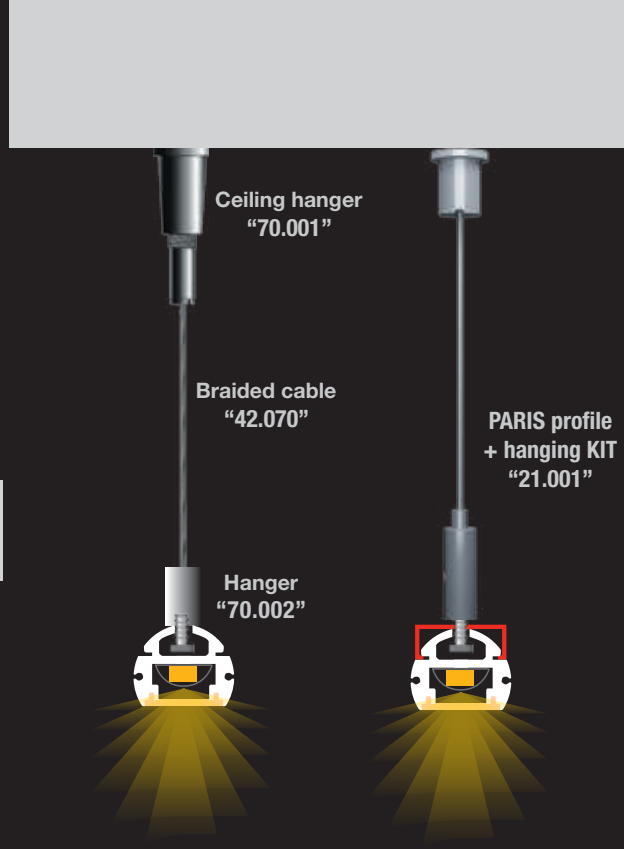
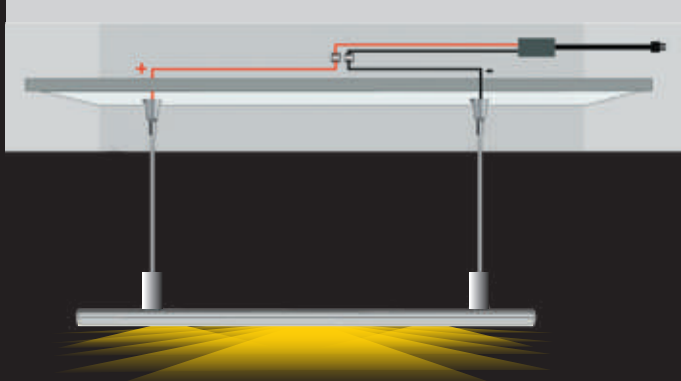

PARIS profile  
+ surface bracket  
"20.007"



PARIS profile  
+ support "22.008"

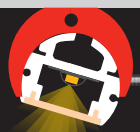

PARIS profile  
+ bracket "20.019"



Hanger  
"70.002"



PARIS profile  
+ hanging KIT  
"21.001"



**Clip**  
20.007 chrome steel  
20.008 black oxide finish



**Ceiling hanger**  
70.001 silver  
70.003 chrome



**Hanger**  
70.002



**Hanging KIT**  
21.001 chrome set of 2 units  
21.002 white set of 2 units  
21.003 black set of 2 units  
(clip not included)



**Braided cable**  
42.070 steel



**Supporting arm**  
22.006 silver anodised  
22.007 black anodised  
22.088 white anodised  
Measurements: 170x50mm  
\* (clip not included)



**Centre support**  
22.008 swivel support



**Clip**  
20.019 metal

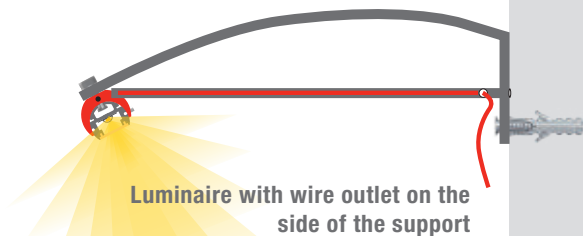

Luminaire with wire outlet on the  
side of the support

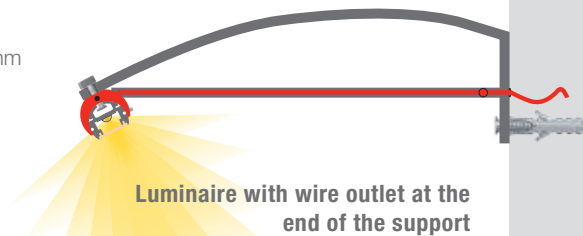

Luminaire with wire outlet at the  
end of the support

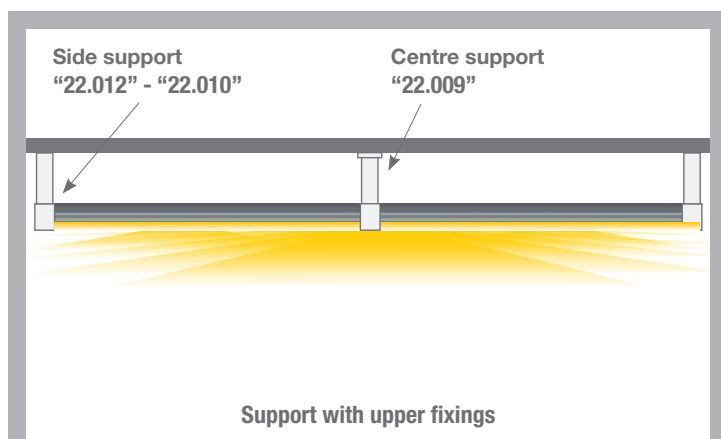

**Centre support**  
22.009 aluminium



**Side support**  
22.010 aluminium



**Side support**  
22.012 aluminium

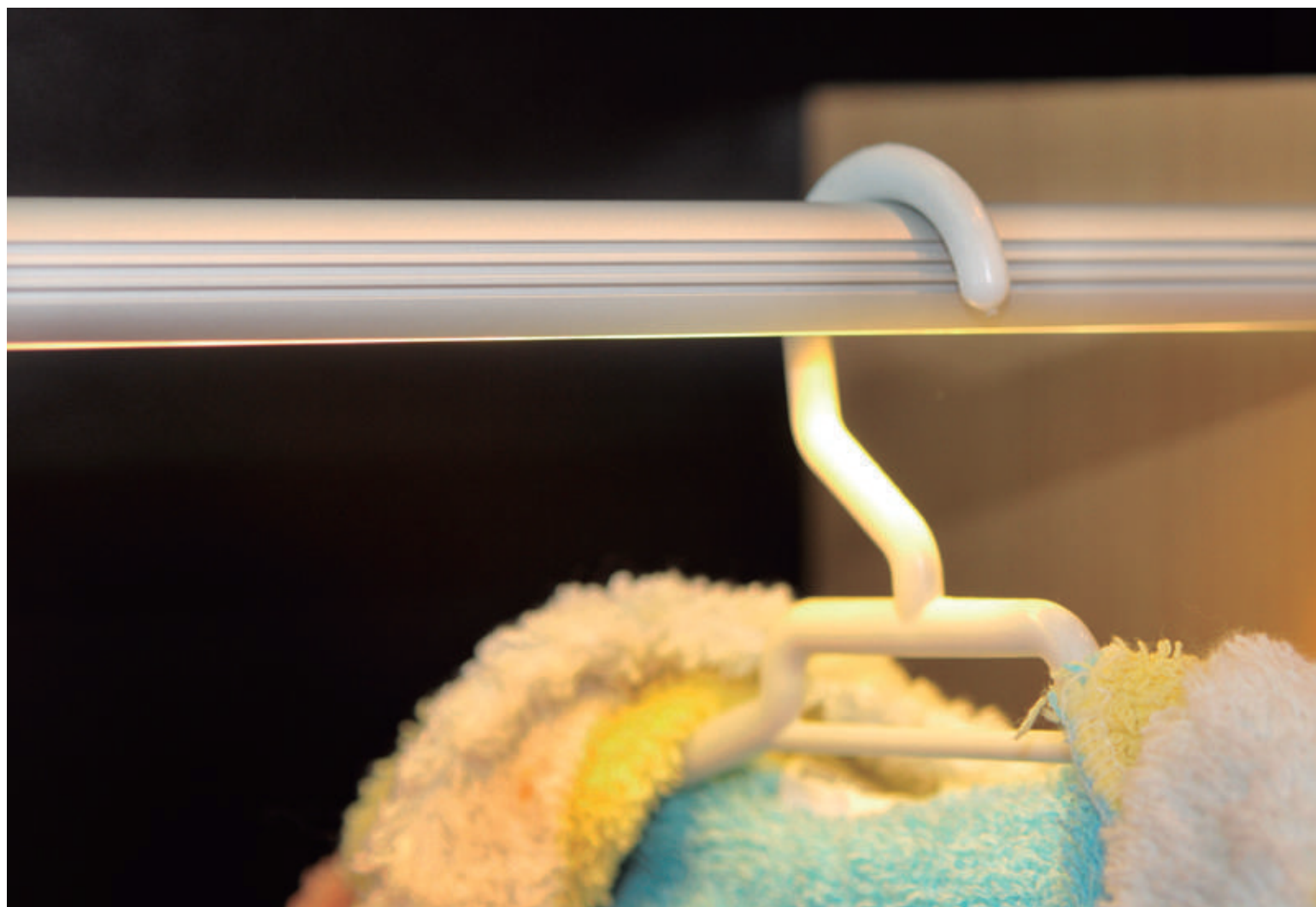

# led profile by Luz Negra

## MIAMI

Our BASIC led profile series for angles and ceiling suspension is manufactured in high purity aluminium and available in anodised silver, lacquered white and raw aluminium (on demand, we can supply different anodised and lacquered finishings. This profile has a wide range of applications, examples of which include ceiling suspended luminaires, luminaires for displaying paintings, wardrobe garment rails, floor or wall mounted luminaires, and others.

It can be used with led strips with a maximum width of 12.5mm and a power not greater than 30W/m. In order to obtain a more homogeneous illumination, while also making the dots invisible, we recommend the combined use of both our frosted covers and Canovelles-Barcelona-Gomera-COB ecoled strips.

**We offer a 2 year guarantee on our profiles and covers.**

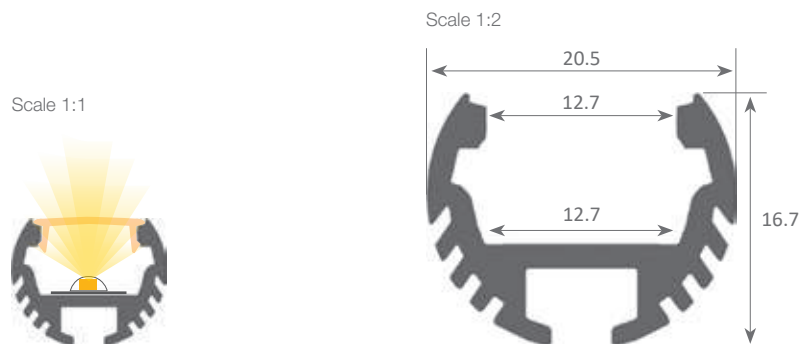

### Aluminium profile

13.007	anodised silver	2m
13.008	white lacquered	2m
13.009	raw	2m
13.010	anodised silver	6m
13.011	white lacquered	6m
13.012	raw	6m



### Polycarbonate cover

18.116	opal	2m
18.146	frosted	2m
18.148	opal	2m
18.018	opal	3m
18.115	opal	6m
18.145	frosted	2m
18.147	opal	2m



### Plastic endcaps

19.091	white with hole
19.092	white without hole
19.093	grey with hole
19.094	grey without hole



### Methacrylate cover

18.014	transparent	2m
18.015	frosted	2m
18.016	transparent	6m
18.017	frosted	6m



### Clip

20.005	transparent plastic
--------	---------------------



### clip

20.019	metal
--------	-------



### Supporting arm

22.006	silver anodised
22.007	black anodised
Measurements: 170x50mm	
* (clip not included)	

Paris complements can also be used



**MIAMI profile  
+ hanging KIT "21.001"**



Aluminium alloy extrusion process in accordance with: ISO 9001:2008 - ISO 14001 / Tolerances defined by: UNE-EN 755-9 / UNE-EN 12020-2  
Theoretical weight: 0.265kg / Alloy: 6063 / Perimeter: 125mm / Anodising minimum: 15 microns  
Aluminium purity: 95-98% / Material treatment: T-5 / Covers: methacrylate (greater protection against UV rays)

Made with Paris XL led Profile  
Cortesy of singular.design





## PARIS XL



IP65

Our PROFESSIONAL led profile series for surfaces and ceiling suspension is manufactured in high purity aluminium and available in anodised silver, black, inox and white lacquered. It covers many uses where we require a width greater than the standard, examples of which include ceiling suspended luminaires, luminaires for displaying paintings, and others. Additionally, its optimum width allows us to use wider led strips for an increased heat dissipation and a wider angle of light emission.

Its upper channel allows us to manufacture square, rectangular or L-shaped hanging luminaires. By combining its "easy-ON" cover (available in 6 different finishings), we provide an IP65 to the luminaire. Therefore, the profile can be used in places with high levels of humidity, for example bathrooms, kitchens, gyms, spas, cold storage chambers, fridges, or others.

The profile and its covers are available in lengths of 2 and 6 metres, thus enabling us to carry about large projects where all the profiles don't need joints. Suitable for led strips with a maximum width of 20mm. Apart from using our flexible led strips, Canovelles-Barcelona-Gomera-COB we can also use rigid ones.

**We offer a 10 year guarantee on profiles and a 4 year guarantee on covers.**

Scale 1:1

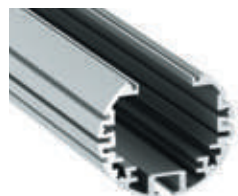
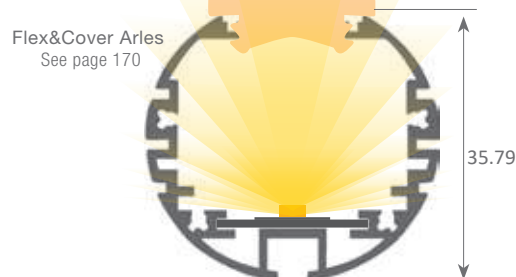
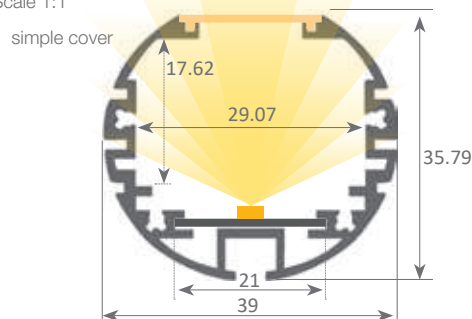

### Perfil de aluminio

13.013	anodised silver	2m
13.015	anodised black	2m
13.033	white lacquered	2m
13.016	anodised silver	6m
13.018	anodised black	6m
13.020	white lacquered	6m



### Aluminium endcaps

19.095	anodised silver
19.096	anodised black
19.432	white lacquered



### Clip

20.020	transparent polycarbonate
20.021	metal



### Supporting arm

22.006	silver anodised
22.007	black anodised
Measurements: 170x50mm	
* (clip not included)	



### Polycarbonate cover "easy-ON"

18.022	transparent	2m
18.023	opal	2m
18.024	frosted	2m
18.030	lens	2m
18.025	transparent	6m
18.026	opal	6m
18.027	frosted	6m
18.031	lens	6m

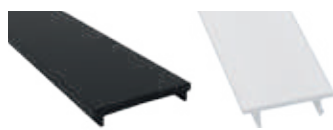

### Black&White cover "easy-ON"

18.028	Black&White	2m
18.029	Black&White	6m

### Polycarbonate cover

18.127	frosted	2m
18.126	frosted	6m

\*Only for WHITE XL profile

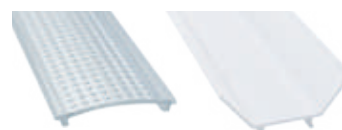

### Polycarbonate cover "easy-ON"

18.130	microprism	2m
18.129	microprism	6m

### Polycarbonate cover with side wings

18.132	frosted	2m
18.131	frosted	6m

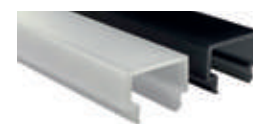

### Square cover

18.032	frosted	2m
18.102	Black&White	2m
18.033	frosted	6m
18.034	Black&White	6m



Patente Europea  
Nº.: 13156605.1

Aluminium alloy extrusion process in accordance with: ISO 9001:2008 - ISO 14001 / Tolerances defined by: UNE-EN 755-9 / UNE-EN 12020-2  
Theoretical weight: 0.740kg / Alloy: 6063 / Perimeter: 341mm / Anodising minimum: 15 microns  
Aluminium purity: 95-98% / Material treatment: T-5 / Covers: Fireproof V0



#### Inner plate

22.036 aluminium 2 m  
22.191 aluminium 6 m



#### 90° angle bracket

22.003 steel



#### Hanging KIT

21.001 chrome set of 2 units  
21.002 white set of 2 units  
21.003 black set of 2 units  
(clip not included)



#### Profile joint

22.005 steel



#### 120° angle bracket

22.004 steel

Scale 1:1

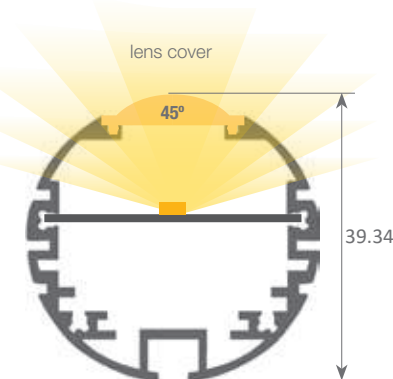
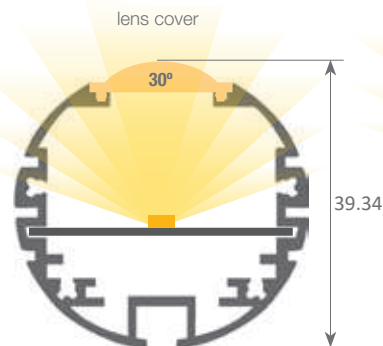
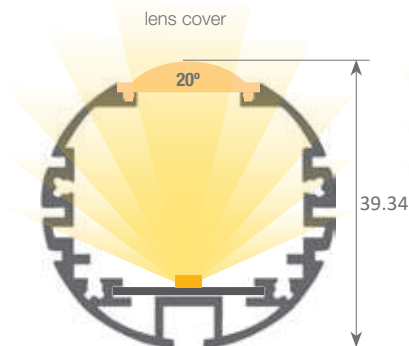

Hanging KIT  
"21.001"

By applying the lens cover on the Paris XL profile together with the flexible led strip we achieve 3 different light angles.  
The information is just approximate. Please check with our technical department

# led profile by Luz Negra

Our PROFESSIONAL led profile series which is manufactured in Black&White, is ideal for surfaces, ceiling suspended luminaires or wall mounted luminaires and similar.

It is suitable for led strips with a maximum width of 15mm and a power not greater than 20W/m. In order to obtain a more homogeneous illumination, while also making a non dot effect, we recommend combining it with our Elite series of led strips, COB and also our ecoled digital model Hawaii RGB.

**We offer a 2 year guarantee.**

## OSLO Black&White

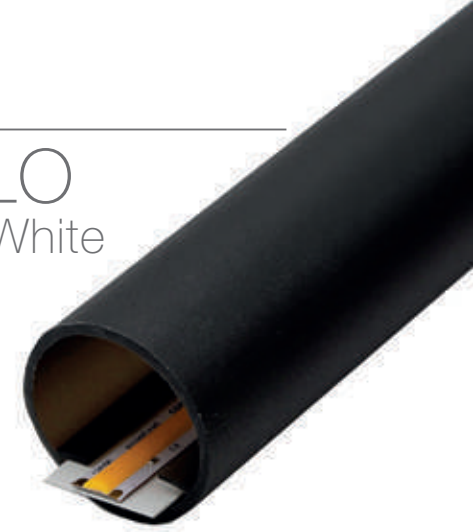

Scale 1:1

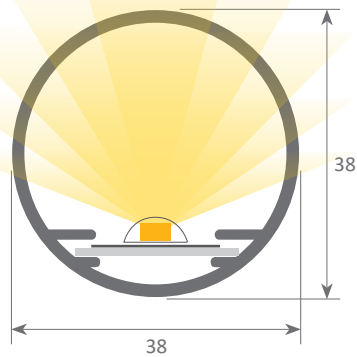

**Methacrylate profile**  
13.020 black frosted 3m



**Endcaps**  
19.104 methacrylate



**Plastic endcaps**  
19.100 blue  
19.101 white  
19.102 black  
19.103 red



**Inner plate**  
22.189 aluminium 3m



**Hanging KIT**  
21.001 chrome set of 2 units  
21.002 white set of 2 units  
21.003 black set of 2 units  
(clip not included)



**Clip**  
20.020 transparent polycarbonate  
20.021 metal

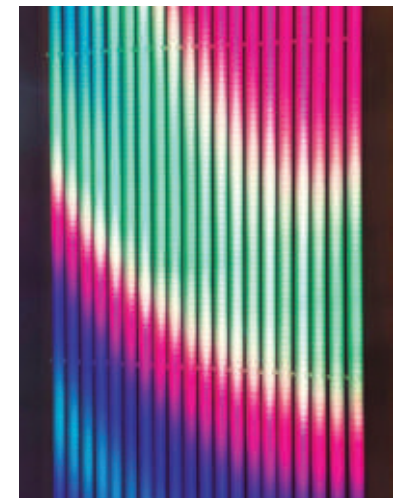

**Oslo Black&White with digital led strip**



Plastic profile extrusion process in accordance with: ISO 9001  
Theoretical weight: 0.275kg/m / Raw material: acrylic PMMA / Perimeter: 119.4mm / Acrylic purity: 99.95%

# led profile by Luz Negra

## OSLO

Our PROFESSIONAL led profile series for surfaces and ceiling suspension is manufactured in white frosted methacrylate. The profile is ideal for surface applications, for example ceiling suspended luminaires or wall mounted luminaires, and similar.

It is suitable for led strips with a maximum width of 15mm and a power not greater than 20W/m. In order to obtain a more homogeneous illumination, while also making the dots invisible, we recommend combining it with our Canovelles-Barcelona-Gomera-COB ecoled strips.

**We offer a 2 year guarantee.**

Scale 1:1

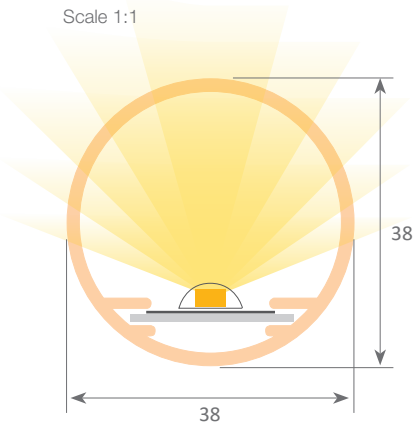

**Methacrylate profile**  
13.019 white frosted 3m



**Endcaps**  
19.099 frosted methacrylate



**Plastic endcaps**  
19.100 blue  
19.101 white  
19.102 black  
19.103 red



**Inner plate**  
22.189 aluminium 3m



**Hanging KIT**  
21.001 chrome set of 2 units  
21.002 white set of 2 units  
21.003 black set of 2 units  
(clip not included)



**Clip**  
20.020 transparent polycarbonate  
20.021 metal



Plastic profile extrusion process in accordance with: ISO 9001  
Theoretical weight: 0.275kg/m / Raw material: acrylic PMMA / Perimeter: 119.4mm / Acrylic purity: 99.95%

# led profile by Luz Negra

Our PROFESSIONAL led profile series for circular is manufactured in high purity aluminium and available in anodised white and white lacquered. The profile has two sliding side wings, modifying the angle of light, thanks to its rounded glazed methacrylate diffuser. It is ideal for use suspended from ceiling\*. Suitable for led strips with a maximum width of 10mm and a power not greater than 21W/m. (Allows the insertion of led strips with a 10mm PCB in sliding form and with an 8mm PCB placed frontwise). We recommend the combined use of both our opal diffusers and COB 8mm ecoled strips. **We offer a 5 year guarantee.**

## VIENA

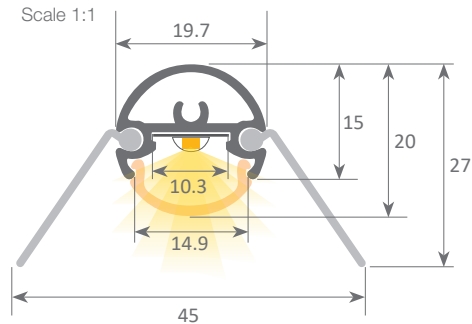

### Aluminium profile

13.026	black anodised	2m
13.029	white lacquered	2m



### Aluminium profile side wing

13.027	black anodised	2m
13.028	white lacquered	2m

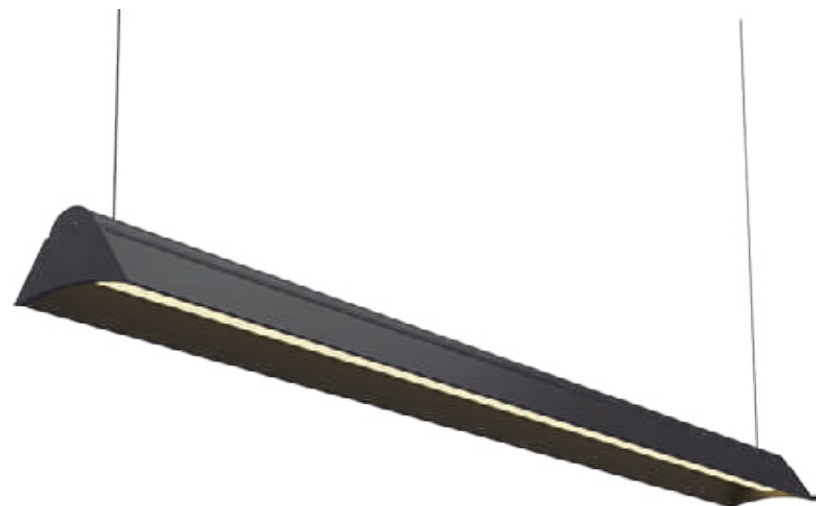

### Methacrylate cover

18.128	frosted	2m
--------	---------	----



### Universal hanging kit with screw connection

21.020	black	set of 2 units
21.021	white	set of 2 units
21.022	chrome	set of 2 units



### Methacrylate endcaps

19.425	white
19.426	black

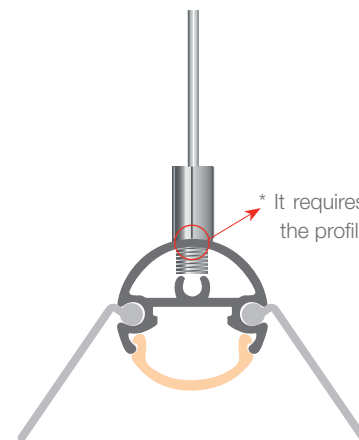

# led profile by Luz Negra

Led profile PROFESSIONAL series, manufactured in white frosted methacrylate. Multifunctional profile, ideal for surface and wall applications, hanging, etc. Suitable for led strips with a width and power not higher than 8mm and 10w/m. We recommend using it with ecoled Cob 8mm in order to achieve a more homogeneous and uniform illumination.

**We Offer a 2 year guarantee.**

## OSLO MINI



Scale 1:1

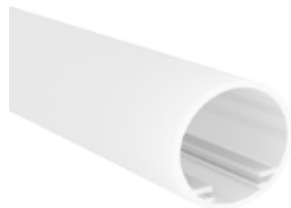
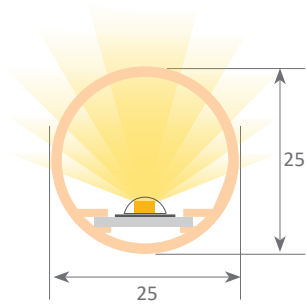

**Methacrylate profile**

13.024 white frosted

3m



**Inner plate**

22.019 aluminium  
(2000x14x0.75mm)



**Hanging KIT**

21.001 chrome set of 2 units  
21.002 white set of 2 units  
21.003 black set of 2 units  
(clip not included)



**Endcaps**

19.361 frosted methacrylate



**Clip**

20.071 polycarbonate transparent



**Tubular base**

22.124 white



**Tubular holding piece**

22.125 white



# led profile by Luz Negra

## OSLO DOBLE

Led profile PROFESSIONAL series for hanging/surface, manufactured in white frosted methacrylate. Multifunctional profile, ideal for applications on surfaces, ceilings, walls, etc. Profile ideal for Up&Down illumination in order to achieve a 360° lighting effect. Suitable for led strips with a width and power not greater than 10mm and 10W/m. We recommend using it with our ecoled strips Élite 5 - COB 5mm in order to obtain a more homogeneous and uniform illumination.

It marks a slight shade on both sides, where the inner plate is placed.

**We offer a 2 year guarantee.**

Scale 1:1

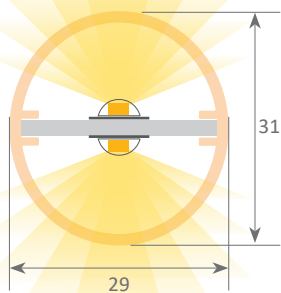

### Methacrylate profile

13.025 white frosted

3m



### Inner plate

22.143 aluminium  
(2000x25x0.75mm)



### Endcaps

19.366 frosted methacrylate



### Clip

20.071 polycarbonate transparent



### Hanging KIT

21.001 chrome set of 2 units  
21.002 white set of 2 units  
21.003 black set of 2 units  
(clip not included)



Plastic profile extrusion process in accordance with: ISO9001  
Theoretical weight: 152gr/m gr/m / Raw material: acrylic PMMA / Perimeter: 94.2mm / Acrylic purity: 99.99%

# led profile by Luz Negra

## OSLO 40

Our PROFESSIONAL led profile series for surfaces and ceiling suspension is manufactured in white frosted methacrylate. The profile is ideal for surface applications, for example ceiling suspended luminaires or wall mounted luminaires, and similar.

It is suitable for led strips with a maximum width of 15mm and a power not greater than 20W/m. In order to obtain a more homogeneous illumination, while also making the dots invisible, we recommend combining it with our Canovelles-Barcelona-Gomera-COB ecoled strips.

**We offer a 2 year guarantee.**



Scale 1:1

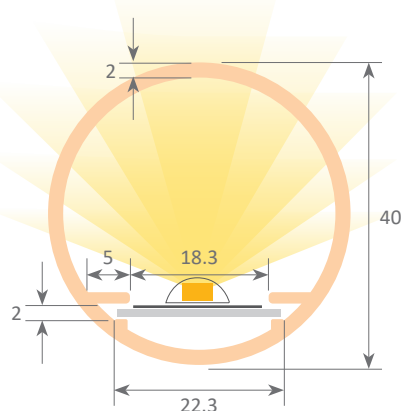

**Methacrylate profile**  
13.031 white frosted 3m



**Endcaps**  
19.420 frosted methacrylate



**Clip**  
20.020 transparent polycarbonate  
20.021 metal



**Inner plate**  
22.189 aluminium 3m



**Hanging KIT**  
21.001 chrome set of 2 units  
21.002 white set of 2 units  
21.003 black set of 2 units  
(clip not included)



Plastic profile extrusion process in accordance with: ISO 9001  
Theoretical weight: 0.275kg/m / Raw material: acrylic PMMA / Perimeter: 119.4mm / Acrylic purity: 99.95%





**Flat crosspiece**

22.118 white  
22.119 black



**Crosspiece**

22.116 white  
22.117 black



**Joining piece**

22.120 white  
22.121 black



**T-shape joining piece**

22.122 white  
22.123 black



**90° angle piece**

22.126 white  
22.127 black



**120° angle piece**

22.128 white  
22.129 black



**Crossing angle piece**

22.130 white  
22.131 black



**Base**

22.132 white  
22.133 black



**Adjustable base**

22.134 white  
22.135 black



**Base**

22.136 white  
22.137 black





led profiles for stairs and skirting boards

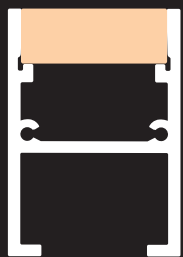

AZORES

106



DUBLIN

107



DUBLIN XL

108



EDIMBURGO

110



LONDRES

111



FLORENCIA

112



NIZA ECO

114



NIZA DUO

115

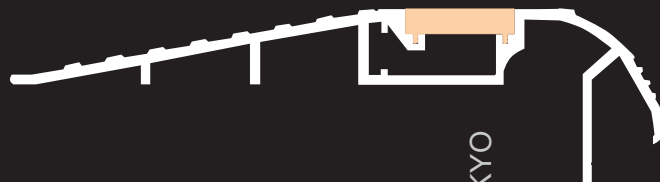

TOKYO

116



ESTAMBUL

118



DUBAI

119



QATAR

120

Our PROFESSIONAL led profile series, treadable for indoor and outdoor use, is manufactured in high purity aluminium and available in anodised silver. Suitable for illuminating stairs and floors, such as gardens, bathrooms, corridors, balconies, and others.

This profile and its covers are available in lengths of 2 metres, allowing us to carry out large projects where all the profiles do not need joints. Suitable for led strips with a maximum width of 17mm and a power not greater than 40W/m. In order to avoid system malfunctions and potential failures, we recommend combining this profile with our Canovelles-Vizcaya ecoled strips or similar products with our DUO waterproof system. When installed under conditions of high humidity, we suggest filling it with Epoxy resin in order to achieve an IP67 rating (a 2mm thick layer on top of the led strip).

**We offer a 2 year guarantee.**

Scale 1:1

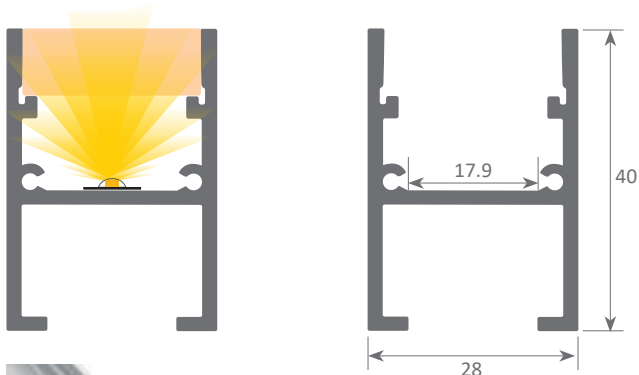

**Aluminium profile**  
07.010 anodised silver 2m



**Endcaps**  
19.224 aluminium white lacquered



**Union endcaps**  
19.356 aluminium



**Polycarbonate cover**  
18.084 opal 2m



**Epoxy Resin**  
22.018 1 Kg  
+ 1 catalyst of 400g



Patente Europea  
Nº.: 13156605.1

Aluminium alloy extrusion process in accordance with: ISO 9001:2008 - ISO 14001 / Tolerances defined by: UNE-EN 755-9 / UNE-EN 12020-2  
Alloy: 6063 / Anodising minimum: 15 microns  
Aluminium purity: 95-98% / Material treatment: T-5 / Covers: Fireproof V0

# led profile by Luz Negra

Our PROFESSIONAL led profile series, treadable and for indoor use is manufactured in high purity aluminium and available in anodised silver. Suitable for a wide range of floor lighting, such as stairs, bathrooms, theatres and similar.

By combining its "easy-ON" cover with this profile, we provide an IP65 protection to the luminaire. Therefore, the profile can be used in places with high levels of humidity, while also being highly durable to treading.

This profile and its covers are available in lengths of 2 and 6 metres, allowing us to carry out large projects where all the profiles do not need joints. Suitable for led strips with a maximum width of 11 mm and a power not greater than 20W/m. In order to avoid system malfunctions and potential failures, we recommend combining this profile with our Canovelles-Vizcaya ecoled strips or similar products with our DUO waterproof system.

When installed under conditions of high humidity, we highly suggest filling it with the resin in order to achieve an IP68 rating.

**We offer a 10 year guarantee on the profiles and a 4 year guarantee on the covers.**

## DUBLIN



IP65



Scale 1:1



Scale 1:2

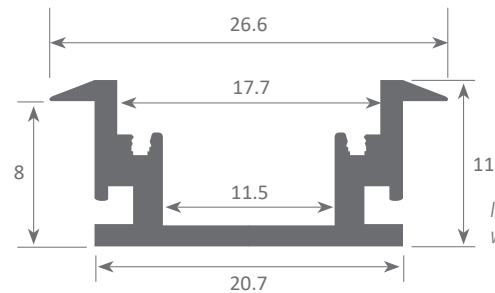

*In order to be able to waterproof approx 12 metres of DUBLIN led profile we would need these quantities of both resin and catalyst.*



### Aluminium profile

07.001 anodised silver 2m  
07.002 anodised silver 6m



### Endcaps

19.116 aluminium



### Polycarbonate cover IK10

18.012 frosted 2m  
18.013 frosted 6m



### Epoxy Resin

22.018 1 Kg  
+ 1 catalyst of 400g



Patente Europea  
Nº.: 13156605.1

Aluminium alloy extrusion process in accordance with: ISO 9001:2008 - ISO 14001 / Tolerances defined by: UNE-EN 755-9 / UNE-EN 12020-2  
Theoretical weight: 0.233 kg / Alloy: 6063 / Perimeter: 111 mm / Anodising minimum: 15 microns  
Aluminium purity: 95-98% / Material treatment: T-5 / Covers: Fireproof V0

# led profile by Luz Negra

Our PROFESSIONAL led profile series, treadable for indoor and outdoor use, is manufactured in high purity aluminium and available in anodised silver. Suitable for illuminating stairs and floors, such as gardens, bathrooms, corridors, balconies, and others.

Its "easy-ON" cover, when combined with this profile, provides an IP65 rating. Therefore, it can be used in places with high levels of humidity, while also being highly resistant to treading.

This profile and its covers are available in lengths of 3 metres, allowing us to carry out large projects where all the profiles do not need joints. Suitable for led strips with a maximum width of 12mm and a power not greater than 30W/m. In order to avoid system malfunctions and potential failures, we recommend combining this profile with our Canovelles-Vizcaya ecoled strips or similar products with our DUO waterproof system. When installed under conditions of high humidity, we suggest filling it with epoxy resin in order to achieve an IP67 rating (a 2mm thick layer on top of the led strip).

**We offer a 10 year guarantee on the profiles and a 4 year guarantee on the covers.**

## DUBLIN XL



IP65

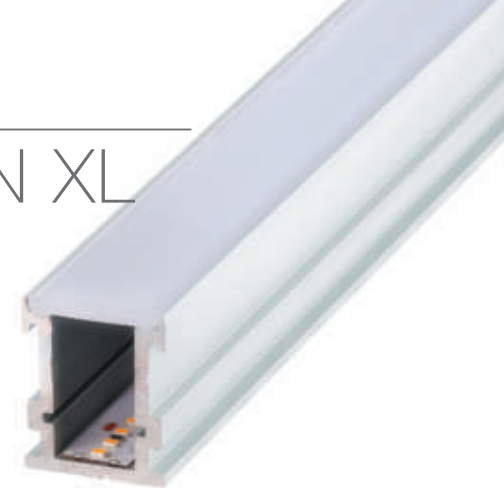

Scale 1:1

*In order to be able to waterproof approx 8-10 metres of DUBLIN XL led profile we would need these quantities of both resin and catalyst.*

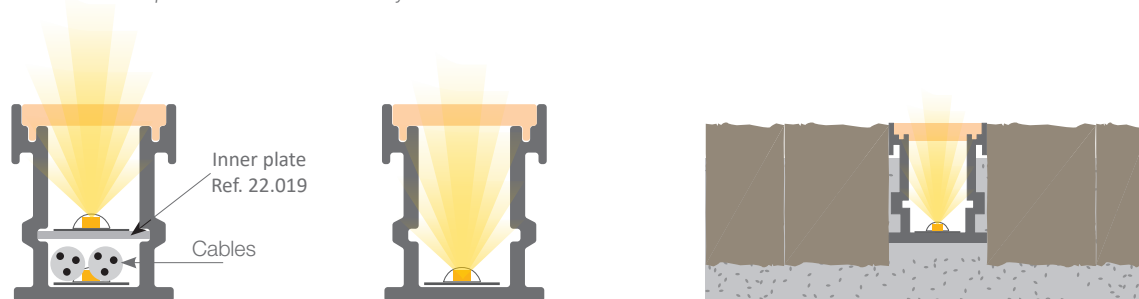

### Aluminium profile

07.003 anodised silver 3m



### Plastic endcaps

19.117 with hole  
19.118 without hole



### Epoxy resin

22.018 1 Kg  
+ 1 catalyst of 400g



### Polycarbonate cover IK10

18.053 opal 3m



### Inner plate

22.019 aluminium 2m  
(2000x14x0.75 mm)

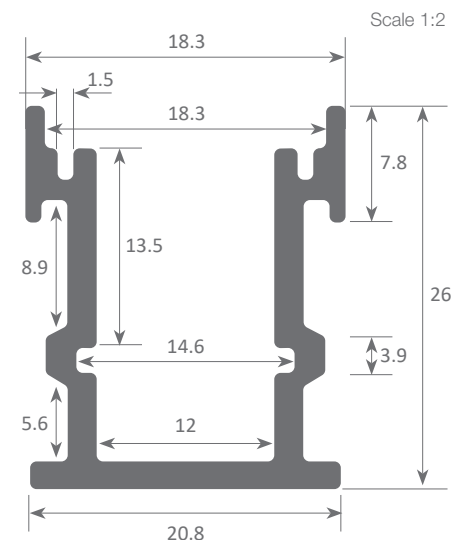

Patente Europea  
Nº.: 13156605.1

Aluminium alloy extrusion process in accordance with: ISO 9001:2008 - ISO 14001 / Tolerances defined by: UNE-EN 755-9 / UNE-EN 12020-2  
Theoretical weight: 0.480 kg / Alloy: 6063 / Perimeter: 176,4 mm / Anodising minimum: 15 microns  
Aluminium purity: 95-98% / Material treatment: T-5 / Covers: Fireproof V0



# led profile by Luz Negra

Our PROFESSIONAL led profile series is for skirting boards, lighting up aisles or corridors and white lacquered aluminium. This profile and its cover are both available in lengths of 2m and can house led strips with a maximum PCB of 13mm width and a power not greater than 20W/m.

We recommend combining it with COB our Granada ecoled strip to obtain a more homogeneous illumination.

It is fixed to the wall with conventional silicone.

**We offer a 2 year guarantee on profiles and covers.**

## EDIMBURGO

Scale 1:1

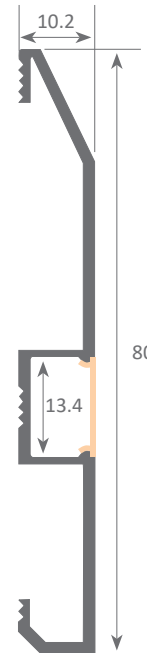
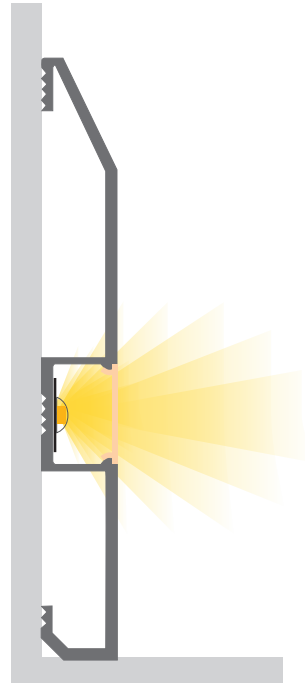

### Aluminium profile

06.008 white lacquered 2m  
(matt)



### Polycarbonate cover

18.052 opal 2m



### Plastic endcaps

19.114 white without hole set of 2 units

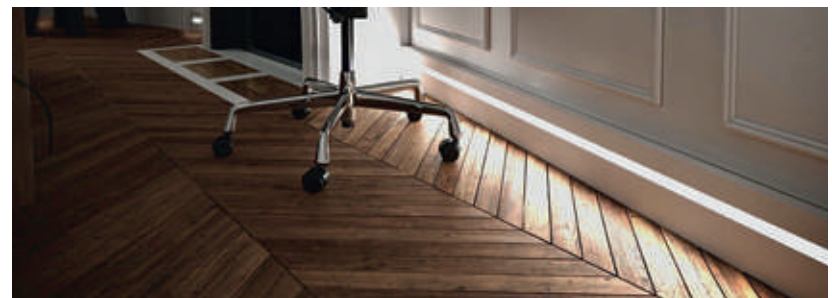

Aluminium alloy extrusion process in accordance with: ISO 9001:2008 - ISO 14001 / Tolerances defined by: UNE-EN 755-9 / UNE-EN 12020-2  
Alloy: 6060 / Anodising minimum: 15 microns  
Aluminium purity: 95-98% / Material treatment: T-5 / Covers: methacrylate (greater protection against UV rays)



# led profile by Luz Negra

Our PROFESSIONAL led profile series is for skirting boards, lighting up aisles or corridors and white lacquered aluminium. This profile and its cover are both available in lengths of 2m and can house led strips with a maximum PCB of 13mm width.

We recommend combining it with COB our Canovelles ecoled strip to obtain a more homogeneous illumination.

It is fixed to the wall with conventional silicone.

**We offer a 2 year guarantee on profiles and covers.**

## LONDRES

Scale 1:1

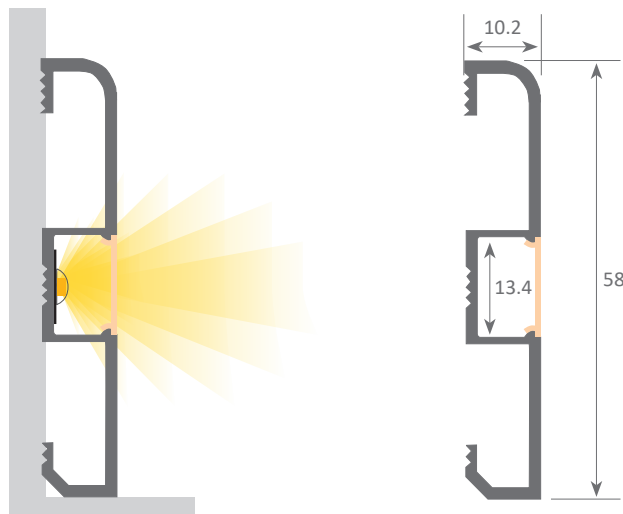

### Aluminium profile

06.009 white lacquered 2m  
(matt)



### Polycarbonate cover

18.052 opal 2m



### Plastic endcaps

19.115 white without hole set of 2 units



Aluminium alloy extrusion process in accordance with: ISO 9001:2008 - ISO 14001 / Tolerances defined by: UNE-EN 755-9 / UNE-EN 12020-2  
Alloy: 6060 / Anodising minimum: 15 microns  
Aluminium purity: 95-98% / Material treatment: T-5 / Covers: methacrylate (greater protection against UV rays)

## FLORENCIA



IP65



Our PROFESSIONAL led profile series, treadable and for indoor use, is manufactured in high purity aluminium and available in anodised silver and black. Suitable for illuminating floors and stairs, bathrooms, corridors, theatres, or similar.

Its "easy-ON" cover, when combined with this profile, provides an IP65 rating. Therefore, the profile can be used in places with high levels of humidity, while also being highly durable to treading. Its double side channels allow us to house all types of cabling (circuit closure wires for avoiding tension drops, telephone cables, etc).

Combined with our rigid led strips, it can be used as an ultra thin surface luminaire for ceilings.

This profile and its covers are available in lengths of 2 and 6 metres, allowing us to carry out large projects where all the profiles do not need joints. Suitable for led strips with a maximum width of 21mm and a power not greater than 40W/m. In order to avoid system malfunctions and potential failures, We recommend combining it with Canovelles our Vizcaya ecoled strip or similar products with our DUO waterproof system.

When installed under conditions of high humidity, we strongly recommend filling the profile with the resin in order to achieve an IP68.

**We offer a 10 year guarantee on the profiles and a 4 year guarantee on the covers.**

Scale 1:1

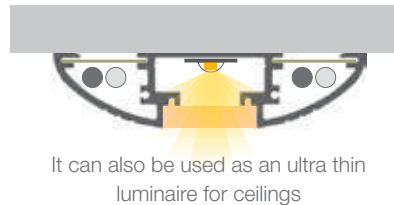
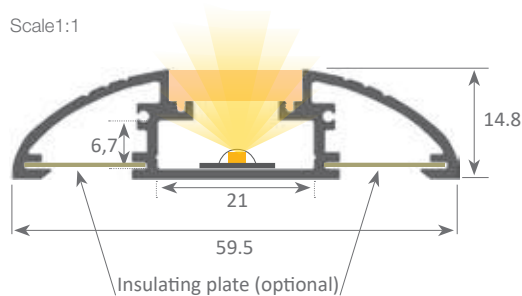

### Aluminium profile

07.004	anodised silver	2m
07.015	anodised black	2m
07.005	anodised silver	6m
07.014	anodised black	6m



### Endcaps

19.119	silver aluminium
19.466	black aluminium
19.120	grey plastic without hole
19.121	grey plastic with hole



### Epoxy resin

22.018	1 Kg
+ 1 catalyst of 400g	



### Polycarbonate cover IK10

18.012	frosted	2m
18.013	frosted	6m



### Inferior insulating plate

22.020	aluminium	2m
--------	-----------	----

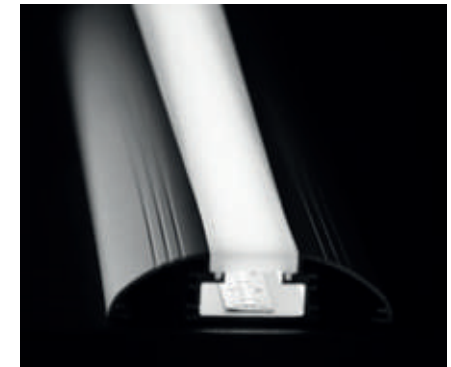
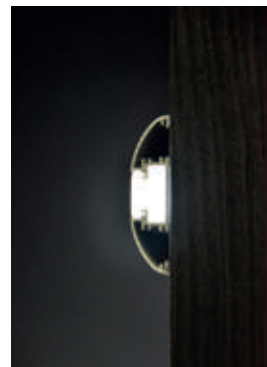

Patente Europea  
Nº.: 13156605.1

Aluminium alloy extrusion process in accordance with: ISO 9001:2008 - ISO 14001 / Tolerances defined by: UNE-EN 755-9 / UNE-EN 12020-2  
Alloy: 6063 / Anodising minimum: 15 microns  
Aluminium purity: 95-98% / Material treatment: T-5 / Covers: Fireproof V0



# led profile by Luz Negra

## NIZA ECO

Our BASIC led profile series, suitable for stair lighting is manufactured in high purity aluminium and available in anodised silver (on demand, we can supply anodised black or other coloured finishings). Its rubber cover, combined with this profile, provides an IP20 rating while at the same time offering a more homogeneous illumination. Although this is an option with reduced dimensions, it is at the same time an economical solution. We recommend using it with our Cies ecoled strips.

**We offer a 2 year guarantee on our profiles and covers.**

Scale 1:1

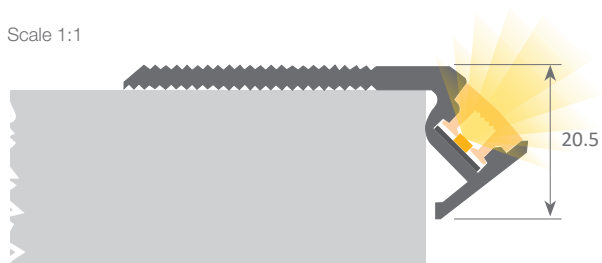

Scale 1:2

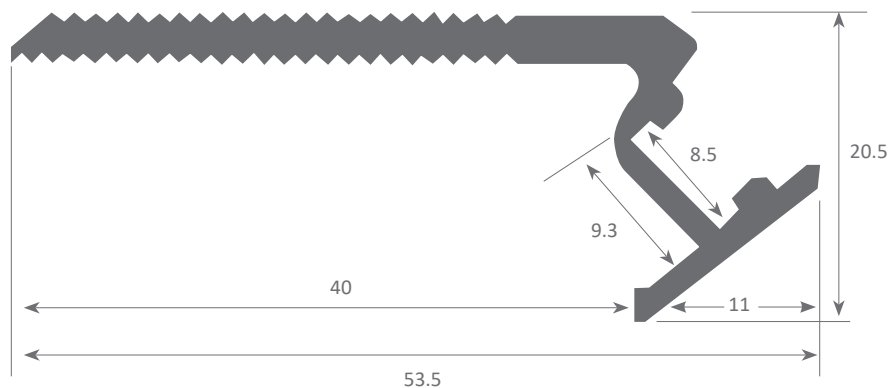

### Aluminium profile

06.001 anodised silver 2.40m



### Plastic endcaps

19.109 grey set of 2 units



### Cover

18.045 opal 2.40m



Aluminium alloy extrusion process in accordance with: ISO 9001:2008 - ISO 14001 / Tolerances defined by: UNE-EN 755-9 / UNE-EN 12020-2  
Alloy: 6063 / Anodising minimum: 15 microns  
Aluminium purity: 95-98% / Material treatment: T-5 / Covers: Fireproof V0

# led profile by Luz Negra

Our BASIC led profile series, suitable for stair lighting is manufactured in high purity aluminium and available in black anodised (on demand can be supplied with silver anodised or other coloured finishings).

Its rubber cover, when combined with this profile, provides an IP20 while also offering a more homogeneous illumination. Also, its design allows us to achieve upward as well as downward light emissions, which is also interesting for lighting up the lower part of the step.

This profile and its cover are available in lengths of 2.40 metres. We recommend using it with our Cies ecoled strips (with PCB not wider than 8mm and IP20).

**We offer a 2 year guarantee on our profiles and covers.**

## NIZA DUO

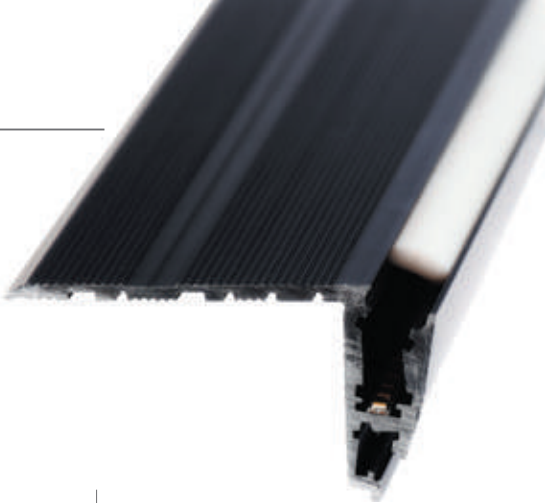

Scale 1:1

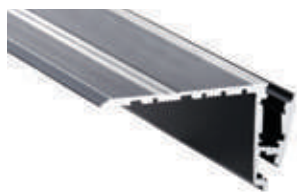
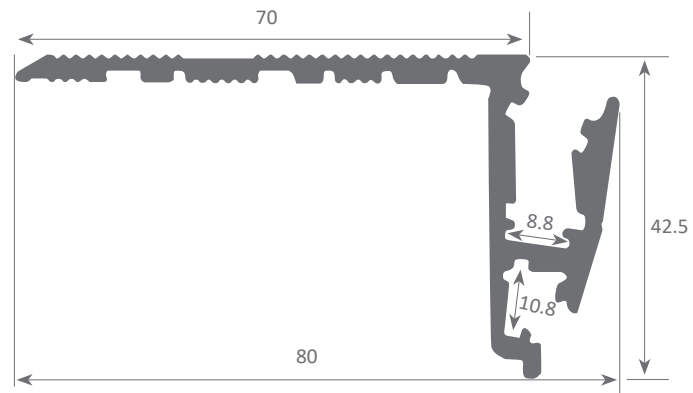

**Aluminium profile**  
06.002 anodised black 2.40m



**Upper cover**  
18.046 white 2.40m



**Endcaps**  
19.110 black aluminium set of 2 units



**Indicator with drawings**  
22.016



**Lower cover**  
18.047 white 2.40m



**(on request)**  
18.048 red 2.40m  
18.049 blue 2.40m  
18.050 yellow 2.40m  
18.051 pink 2.40m



**Indicator with numbers**  
22.015



Aluminium alloy extrusion process in accordance with: ISO 9001:2008 - ISO 14001 / Tolerances defined by: UNE-EN 755-9 / UNE-EN 12020-2  
Alloy: 6063 / Anodising minimum: 15 microns  
Aluminium purity: 95-98% / Material treatment: T-5 / Covers: Fireproof V0

# led profile by Luz Negra

Our PROFESSIONAL led profile series, treadable and for indoor use is manufactured in high purity aluminium and available in anodised silver and black.

Its "easy-ON" cover, when combined with this profile, provides an IP65 rating. Therefore, the profile can be used in places with high levels of humidity, while also being highly durable to treading. Front lighting is achieved by placing a led strip with a maximum width of 14mm under the cover. Additionally, by means of a metal plate, we can obtain side lighting, thus ensuring a perfect dot free light emission. The step's lower area can also be illuminated by using a second led strip.

This profile and its cover are both available in lengths of 2 and 6 metres, allowing us to carry out large projects where all the profiles do not need joints. In order to avoid system malfunctions and potential failures, we recommend combining the profile with our Canovelles-Vizcaya led strips or similar products with our DUO waterproof system. For side lighting, we use a metal plate and we recommend the use of our Granada-Cies-Alicante or Avila ecoled strips with this profile.

**We offer a 10 year guarantee on the profiles and a 4 year guarantee on the covers.**

## TOKYO



IP65

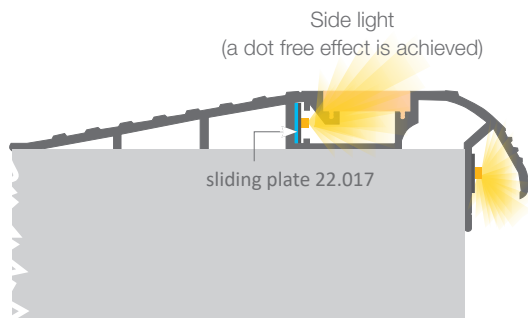
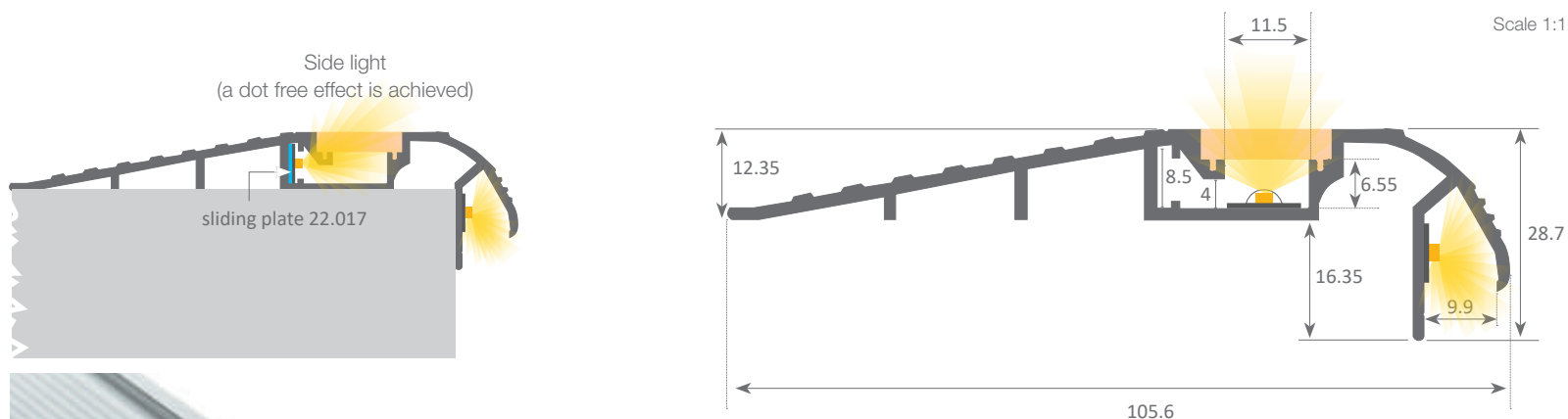

### Aluminium profile

06.003	anodised silver	2m
06.004	anodised black	2m
06.005	anodised silver	6m
06.006	anodised black	6m

### Plastic endcaps

19.111	grey	set of 2 units
19.112	black	set of 2 units



### Polycarbonate cover IK10

18.012	frosted	2m
18.013	frosted	6m



### Inner plate

22.017	aluminium	2m
--------	-----------	----



Patente Europea  
Nº.: 13156605.1

Aluminium alloy extrusion process in accordance with: ISO 9001:2008 - ISO 14001 / Tolerances defined by: UNE-EN 755-9 / UNE-EN 12020-2  
Theoretical weight: 0.813 kg / Alloy: 6063 / Perimeter: 384 mm / Anodising minimum: 15 microns  
Aluminium purity: 95-98% / Material treatment: T-5 / Covers: Fireproof V0

A man with a mustache, wearing a grey sweater and dark pants, sits on a wide staircase. The steps are illuminated from below with a warm, orange glow. The walls on either side are covered in a complex, perforated metal lattice. The lighting is dramatic, with deep shadows and bright highlights from the steps.

Project carried out by the architect Juan Carlos Roure with the collaboration of Lumen's Boulevard.

# led profile by Luz Negra

## ESTAMBUL

Our PROFESSIONAL led profile series, treadable and for indoor use, is intended for achieving illuminated joints on carpets, parquet floor or similar. It is manufactured in high purity aluminium and available in anodised black.

This profile and its covers are available in lengths of 3 metres and allow you to house led strips with a maximum PCB width of 10mm.

We recommend combining this profile with ecoled Canovelles to obtain a dot free effect.

**We offer a 2 year guarantee on our profiles and covers.**



Scale 1:1

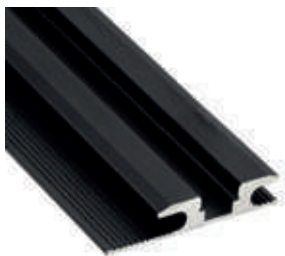
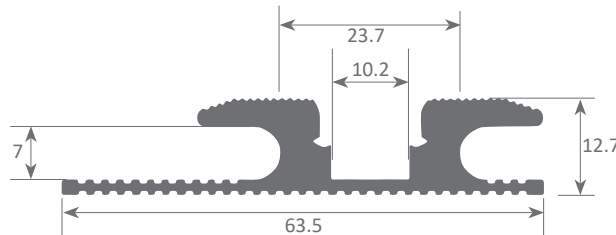

### Aluminium profile

07.008 anodised black 3m

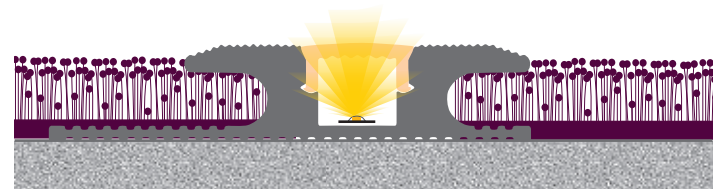

Estambul profile used on carpet



### Polycarbonate cover

18.055 frosted 3m



### Endcaps

19.124 anodised black

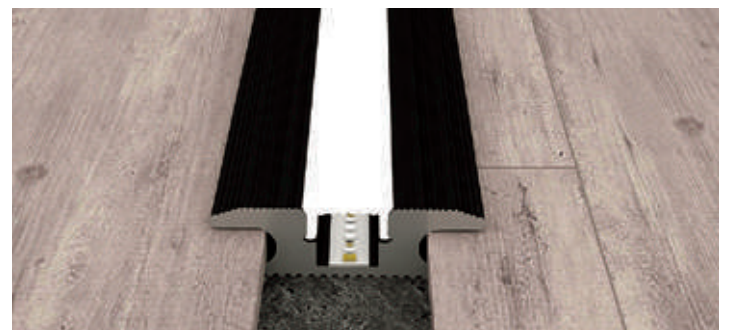

Estambul profile used on parquet



Aluminium alloy extrusion process in accordance with: ISO 9001:2008 - ISO 14001 / Tolerances defined by: UNE-EN 755-9 / UNE-EN 12020-2  
Theoretical weight: 2,2 kg / Alloy: 6060 / Anodising minimum: 15 microns  
Aluminium purity: 95-98% / Material treatment: T-5 / Covers: Fireproof V0



# led profile by Luz Negra

## DUBAI

Our PROFESSIONAL led profile series, manufactured in black anodised is intended for achieving illuminated joints on carpets, parquet floor or similar. Suitable for illuminating parquet floors, stairs, carpets or others.

This profile and its covers are available in lengths of 3 metres and allow to house led strips with a maximum PCB width of 10mm.

We recommend combining this profile with ecoled Canovelles to obtain a dot free effect.

**We offer a 2 year guarantee on our profiles and covers.**



Scale 1:1

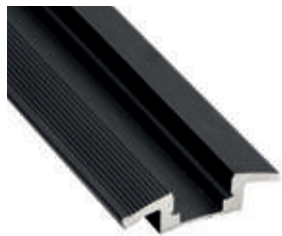
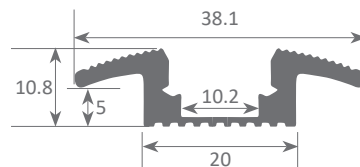

### Aluminium profile

07.009 anodised black 3m

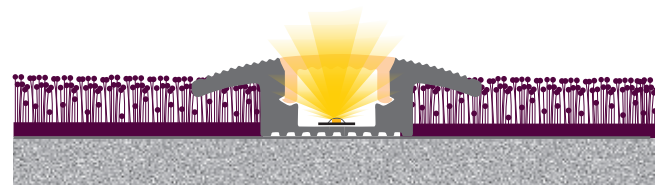

Dubái profile used on carpet



### Polycarbonate cover

18.055 frosted 3m



### Endcaps

19.125 anodised black



Dubái profile used on parquet



Aluminium alloy extrusion process in accordance with: ISO 9001:2008 - ISO 14001 / Tolerances defined by: UNE-EN 755-9 / UNE-EN 12020-2  
Theoretical weight: 1,025 kg / Alloy: 6060 / Anodising minimum: 15 microns  
Aluminium purity: 95-98% / Material treatment: T-5 / Covers: Fireproof V0

# led profile by Luz Negra

## QATAR

Our PROFESSIONAL led profile series, treadable and for indoor use, is manufactured in high purity aluminium and available in anodised black. It is intended for lateral side lighting, and suitable for illuminating floors and stairs, or others.

This profile and its covers are available in lengths of 3 metres and allow you to house led strips with a maximum PCB width of 10mm.

We recommend combining this profile with ecoled Canovelles to obtain a dot free effect.

**We offer a 2 year guarantee on our profiles and covers.**



Scale 1:1

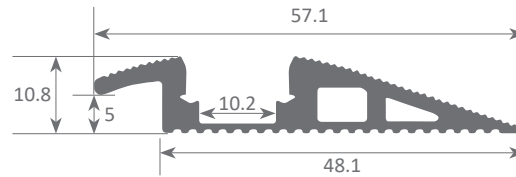

Scale 1:2

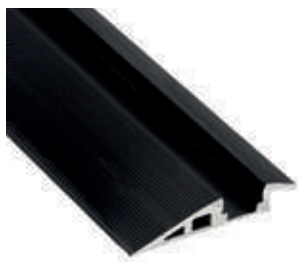

### Aluminium profile

07.007 anodised black 3m  
07.012 anodised silver 3m

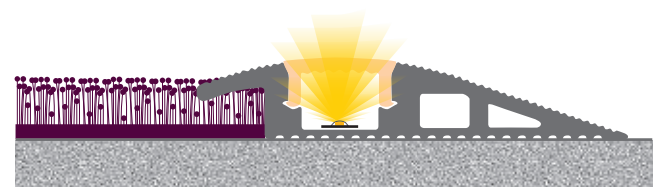

Qatar profile used on carpet



### Polycarbonate cover

18.055 frosted 3m



### Endcaps

19.123 anodised black

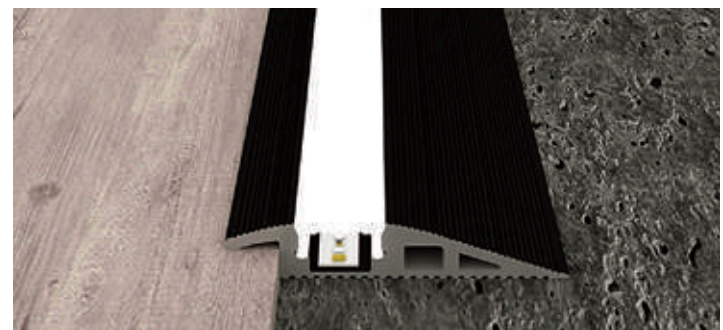

Qatar profile used on parquet



Aluminium alloy extrusion process in accordance with: ISO 9001:2008 - ISO 14001 / Tolerances defined by: UNE-EN 755-9 / UNE-EN 12020-2  
Theoretical weight: 1,5 kg / Alloy: 6060 / Anodising minimum: 15 microns  
Aluminium purity: 95-98% / Material treatment: T-5 / Covers: Fireproof VØ

nk PORCELANOSA Grupo

nk brassware

# architectural led profiles



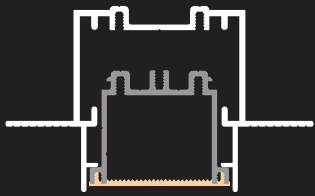

MADEIRA

124



PRAGA

126



BELFAST

127



BUDAPEST

128

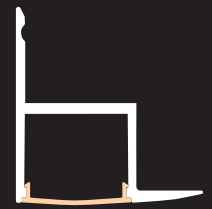

KANSAS

129



MONTANA

130



ALASKA

131



PORTLAND

132



BALTIMORE

133

# led profile by Luz Negra

Our PROFESSIONAL led profile series is manufactured in high purity aluminium and is available in raw aluminium. It is ideal for illuminating ceilings and wall surfaces, where the profile is perfectly integrated. These optimum adherence properties are achievable thanks to Madeira's two side trims, which end up entirely covered under the plaster wall's surface once the mounting has been finished. We recommend the use of a metal mesh on our Madeira, in order to strengthen the mounted joints and also to avoid cracks in the future.

It is suitable for led strips with a maximum width of 20mm and a power not greater than 30W/m. In order to obtain a more homogeneous illumination while also improving the dot free effect, we recommend the use of our Canovelles-Barcelona-Gomera-COB ecoled strips.

**We offer a 10 year guarantee on our profiles and covers.**

## MADEIRA



IP65



Scale 1:1

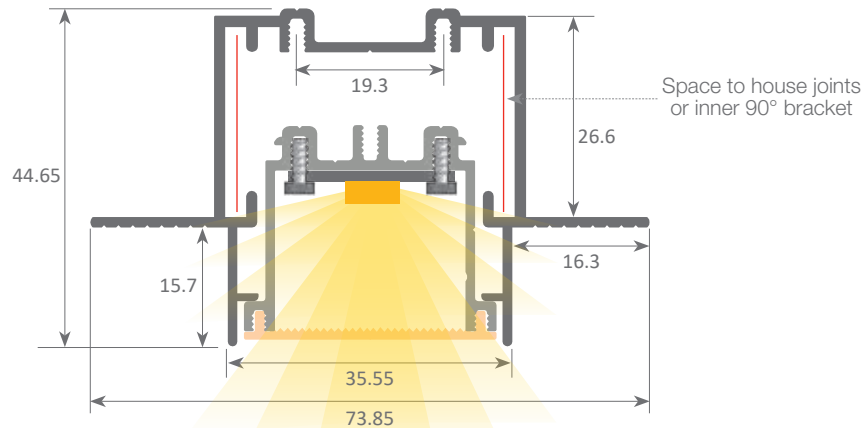

**Aluminium profile**

08.009 raw

6m



**Aluminium tray**

15.007 lacquered white 6 m



**Aluminium endcaps**

19.213 raw

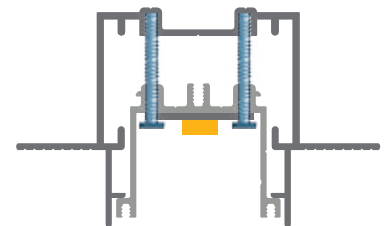

Fixing screws between Madeira tray and profile (Ref: 22.080)



**“easy-ON” cover**

18.070 “easy-ON” frosted 6m  
 18.071 transparent microprism 6m  
 18.072 frosted microprism 6m  
 18.073 Black&White 6m



**90° angle bracket**

22.035 aluminium set of 2 units



**Flat bracket**

22.058 aluminium set of 2 units



**Safety cable**

22.039 steel 18cm



Aluminium alloy extrusion process in accordance with: ISO 9001:2008 - ISO 14001 / Tolerances defined by: UNE-EN 755-9 / UNE-EN 12020-2  
 Theoretical weight: 0.756kg / Alloy: 6063 / Perimeter: 409mm / Anodising minimum: 15 microns  
 Aluminium purity: 95-98% / Material treatment: T-5 / Covers: methacrylate (greater protection against UV rays)



## Front removable tray system with triple fall protection (safety anchorage)

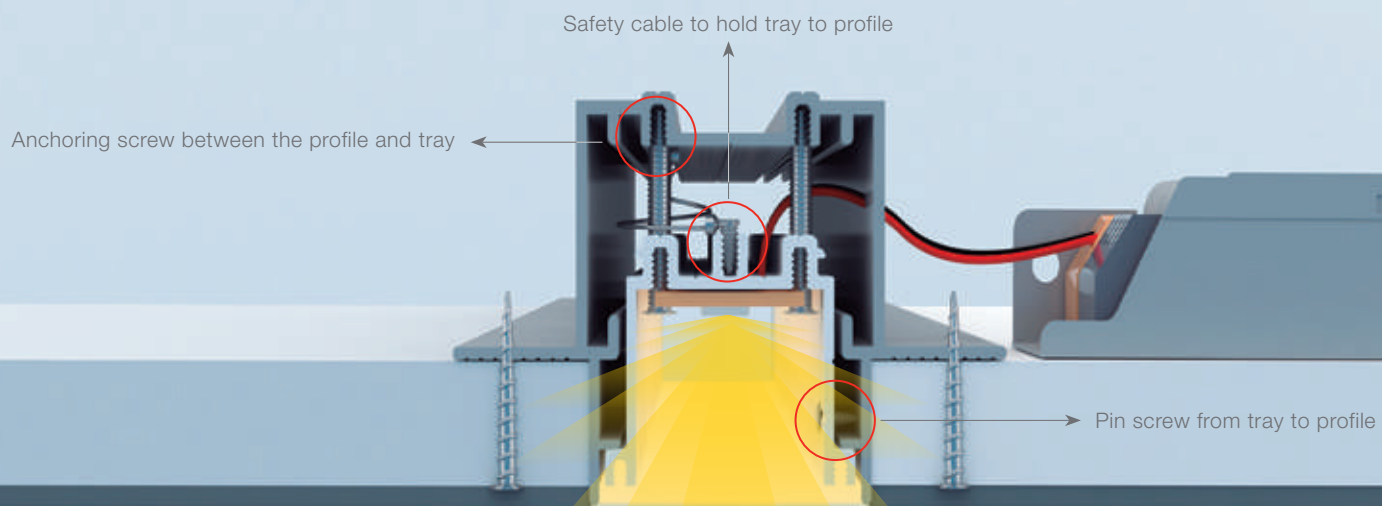

# led profile by Luz Negra

## PRAGA

Our PROFESSIONAL led profile series for recessing is manufactured in high purity white lacquered aluminium.

The cover is available in opal white. This profile allows us to house a rigid led strip, achieving high luminosity (specially suitable for supermarkets, shopping centres, etc.).

This profile and its covers are available in 2m lengths.

**We offer a 2 year guarantee on our profiles and covers.**



Scale 1:1

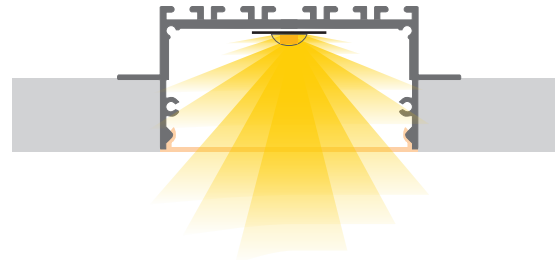
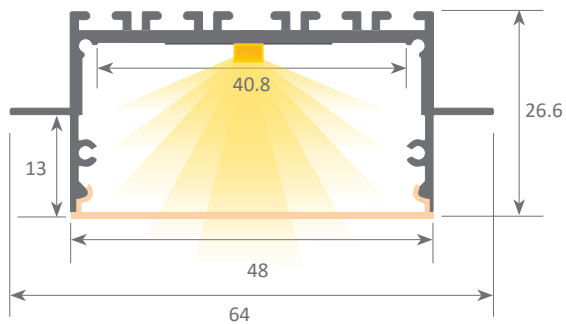

**Aluminium profile**  
08.007 white lacquered 2m



**Aluminium endcaps**  
19.136 without hole



**Polycarbonate cover**  
18.059 opal 2m

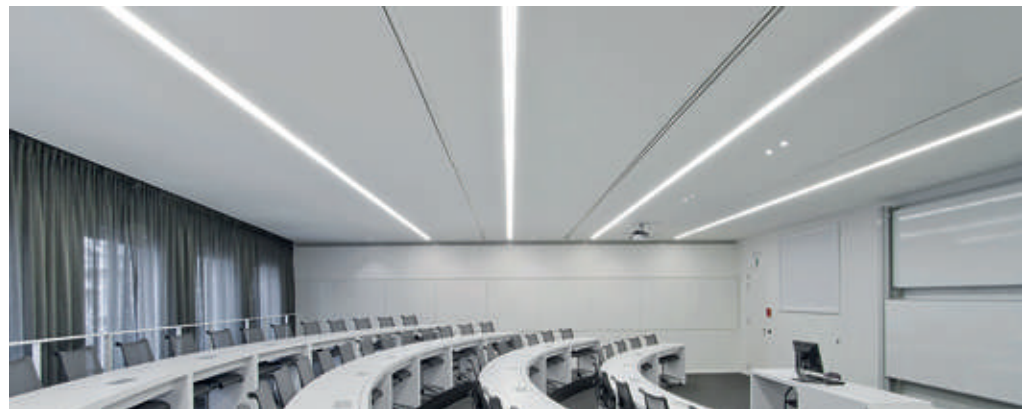

Aluminium alloy extrusion process in accordance with: ISO 9001:2008 - ISO 14001 / Tolerances defined by: UNE-EN 755-9 / UNE-EN 12020-2  
Alloy: 6060 / Anodising minimum: 15 microns  
Aluminium purity: 95-98% / Material treatment: T-5 / Covers: methacrylate (greater protection against UV rays)



# led profile by Luz Negra

Our PROFESSIONAL led profile series for recessing is manufactured in high purity white lacquered aluminium.

The cover is available in opal white. This profile allows us to house a rigid led strip, achieving high luminosity (specially suitable for supermarkets, shopping centres, etc).

This profile and its covers are available in 2m lengths.

**We offer a 2 year guarantee on our profiles and covers.**

## BELFAST



Scale 1:1

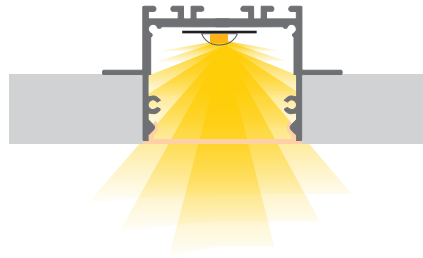
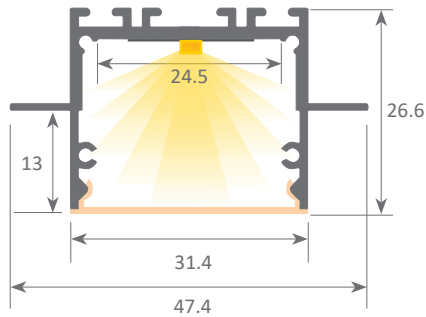

**Aluminium profile**  
08.006 white lacquered 2m



**Aluminium endcaps**  
19.135 without hole



**Polycarbonate cover**  
18.058 opal 2m

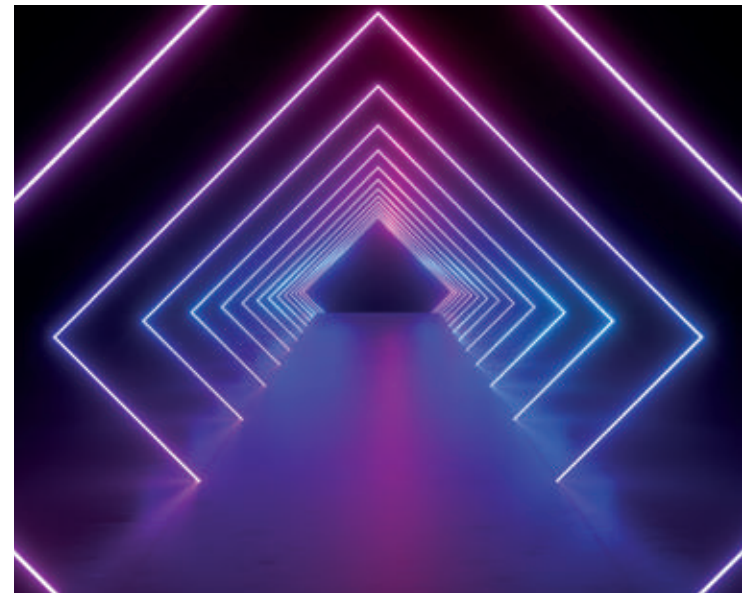

Aluminium alloy extrusion process in accordance with: ISO 9001:2008 - ISO 14001 / Tolerances defined by: UNE-EN 755-9 / UNE-EN 12020-2  
Alloy: 6060 / Anodising minimum: 15 microns  
Aluminium purity: 95-98% / Material treatment: T-5 / Covers: methacrylate (greater protection against UV rays)

Our PROFESSIONAL led profile series for recessing is manufactured in high purity white lacquered aluminium.

The cover is available in opal white finishing. This profile allows us to use a flexible led strip with a power not greater than 20W/m. We recommend using ecoled Élite.

Both profile and covers are available in 2m lengths.

**We offer a 2 year guarantee on our profiles and covers.**



Scale 1:1

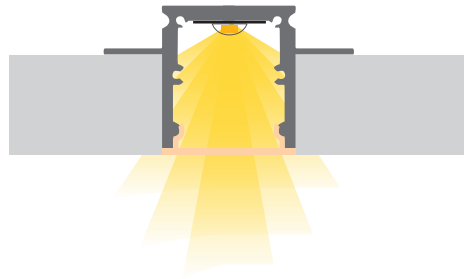
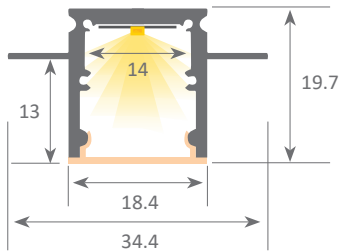

### Aluminium profile

08.005 white lacquered 2m



### Aluminium endcaps

19.134 white without hole



### Polycarbonate cover

18.057 opal 2m

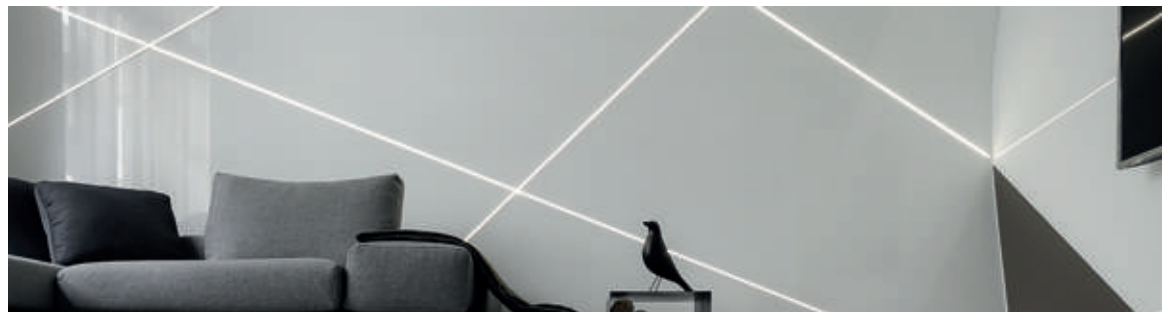

Aluminium alloy extrusion process in accordance with: ISO 9001:2008 - ISO 14001 / Tolerances defined by: UNE-EN 755-9 / UNE-EN 12020-2  
Alloy: 6060 / Anodising minimum: 15 microns  
Aluminium purity: 95-98% / Material treatment: T-5 / Covers: methacrylate (greater protection against UV rays)

# led profile by Luz Negra

Our BASIC led profile series for ceilings and walls is manufactured in high purity aluminium, available in silver anodised. This profile is designed to be used in ceilings or walls, offering an easy, elegant and perimetral lighting.

This is perfect for concealing the edges in false ceilings. It is suitable for led strips with a maximum width of 20mm and a power not greater than 40W/m. We recommend using 20mm rigid led strips or ecoled Éite.

**We offer a 2 year guarantee on our profiles and covers.**

## KANSAS



Scale 1:1

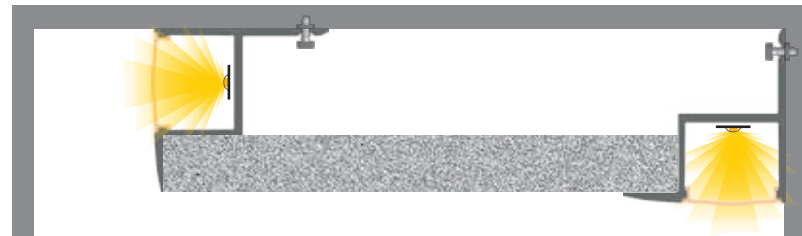
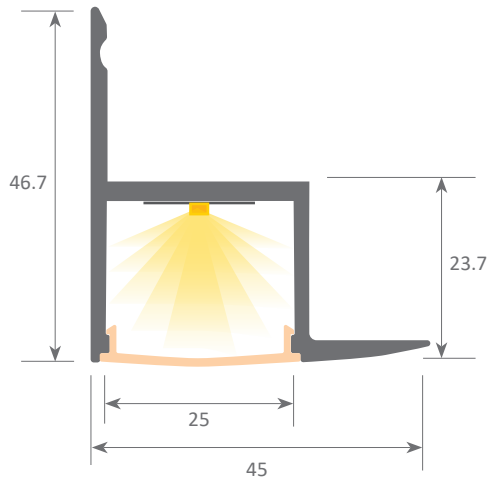

### Aluminium profile

08.008 anodised silver 2m



### Polycarbonate cover

18.060 frosted 2m

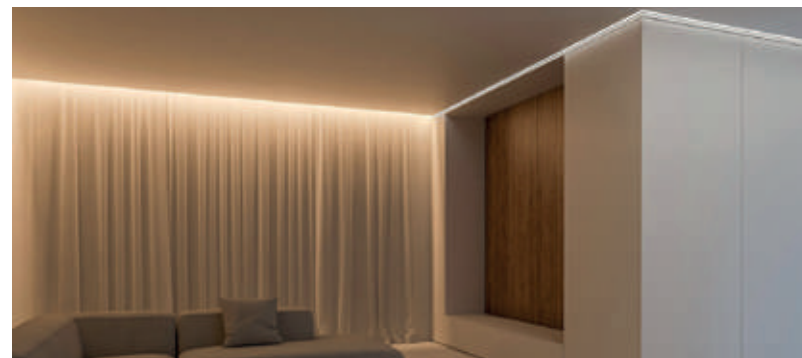

Aluminium alloy extrusion process in accordance with: ISO 9001:2008 - ISO 14001 / Tolerances defined by: UNE-EN 755-9 / UNE-EN 12020-2  
Theoretical weight: 0.7kg / Alloy: 6063 / Perimeter: 223.30mm / Anodising minimum: 15 microns  
Aluminium purity: 95-98% / Material treatment: T-5 / Covers: methacrylate (greater protection against UV rays)

# led profile by Luz Negra

## MONTANA

Our PROFESSIONAL led profile series is manufactured in high purity aluminium and is available in silver anodised. It is ideal for illuminating ceilings and wall surfaces, where the profile is perfectly integrated. These optimum adherence properties are achievable thanks to Montana's two perforated side trims, which end up entirely covered under the plaster wall's surface once the mounting has been finished. We recommend the use of a metal mesh on our Montana, in order to strengthen the mounted joints and also to avoid cracks in the future.

It is suitable for led strips with a maximum width of 20mm and a power not greater than 30W/m. In order to obtain a more homogeneous illumination while also improving the dot free effect, we recommend combining it with our Canovelles-Barcelona-Gomera-COB ecoled strips. It can also be combined with our rigid led strips.

**We offer a 2 year guarantee on our profiles and covers.**

Scale 1:1

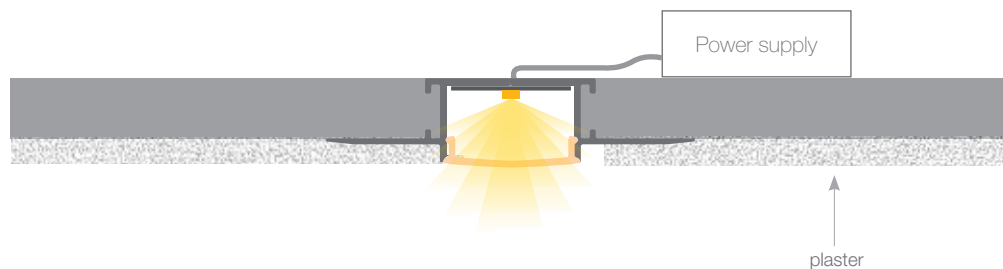
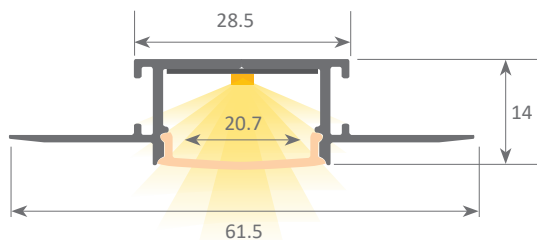

**Aluminium profile**  
08.004 anodised silver 2m



**Plastic endcaps**  
19.132 grey without hole  
19.133 grey with hole



**Polycarbonate cover**  
18.056 frosted 2m

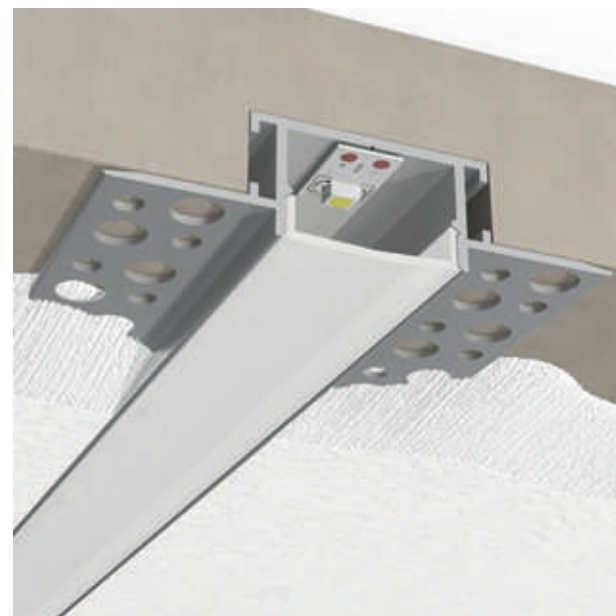

Aluminium alloy extrusion process in accordance with: ISO 9001:2008 - ISO 14001 / Tolerances defined by: UNE-EN 755-9 / UNE-EN 12020-2  
Alloy: 6063 / Anodising minimum: 15 microns  
Aluminium purity: 95-98% / Material treatment: T-5 / Covers: methacrylate (greater protection against UV rays)

## ALASKA

Our PROFESSIONAL led profile series is manufactured in high purity aluminium and available in silver anodised. The profile is ideal for illuminating bathrooms, kitchens and similar areas, where it is mounted on tiles, ceramic or stoneware surfaces. Also, due to its perforated L-shaped trim, it is easy to fit the profile into concrete and this way we achieve a perfect adhesion to the wall.

This profile has one trim and can be mounted between two tiles or used as a corner/wall ending. It is suitable for led strips with a maximum width of 12.5mm and a power not greater than 20W/m. In order to obtain a more homogeneous illumination, while also improving the dot free effect, we recommend combining it with our Canovelles-Barcelona-Gomera-COB ecoled strips.

**We offer a 2 year guarantee on our profiles and covers.**



Scale 1:1

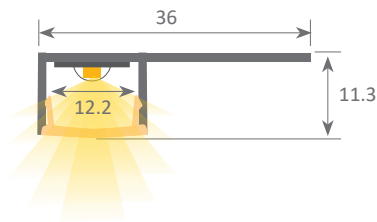

### Aluminium profile

08.001 anodised silver 3m

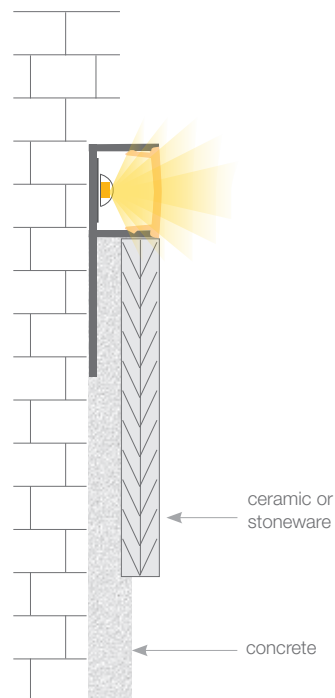

### Polycarbonate cover

18.116	opal	2m
18.146	frosted	2m
18.148	opal	2m
18.018	opal	3m
18.115	opal	6m
18.145	frosted	2m
18.147	opal	2m



### Methacrylate cover

18.014	transparent	2m
18.015	frosted	2m
18.016	transparent	6m
18.017	frosted	6m



### Plastic endcaps

19.126	grey without hole
19.127	grey with hole



Aluminium alloy extrusion process in accordance with: ISO 9001:2008 - ISO 14001 / Tolerances defined by: UNE-EN 755-9 / UNE-EN 12020-2  
Theoretical weight: 0.198kg / Alloy: 6063 / Perimeter: 111.8mm / Anodising minimum: 15 microns  
Aluminium purity: 95-98% / Material treatment: T-5 / Covers: methacrylate (greater protection against UV rays)

## PORTLAND

Our PROFESSIONAL led profile series is manufactured in high purity aluminium and available in silver anodised. This profile is ideal for illuminating bathrooms, kitchens and similar areas, where it is mounted on tiles, ceramic or stoneware surfaces. Also, due to its two perforated L-shaped trims, it is easy to fit the profile into concrete in order to achieve a perfect adhesion to the wall. This profile is designed for outer corners.

It is suitable for led strips with a maximum width of 12.5mm and a power not greater than 20W/m. In order to obtain a more homogeneous illumination while also improving the dot free effect, we recommend combining it with our Canovelles-Barcelona-Gomera-COB ecoled strips.

**We offer a 2 year guarantee on our profiles and covers.**

Scale 1:1

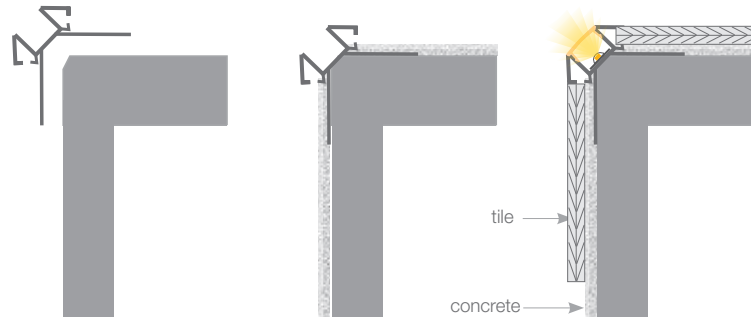
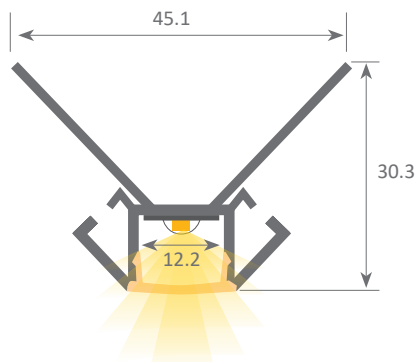

### Aluminium profile

08.003 anodised silver 3m



### Plastic endcaps

19.130 white without hole

19.131 white with hole



### Polycarbonate cover

18.116 opal 2m

18.146 frosted 2m

18.148 opal 2m

18.018 opal 3m

18.115 opal 6m

18.145 frosted 2m

18.147 opal 2m



### Methacrylate cover

18.014 transparent 2m

18.015 frosted 2m

18.016 transparent 6m

18.017 frosted 6m

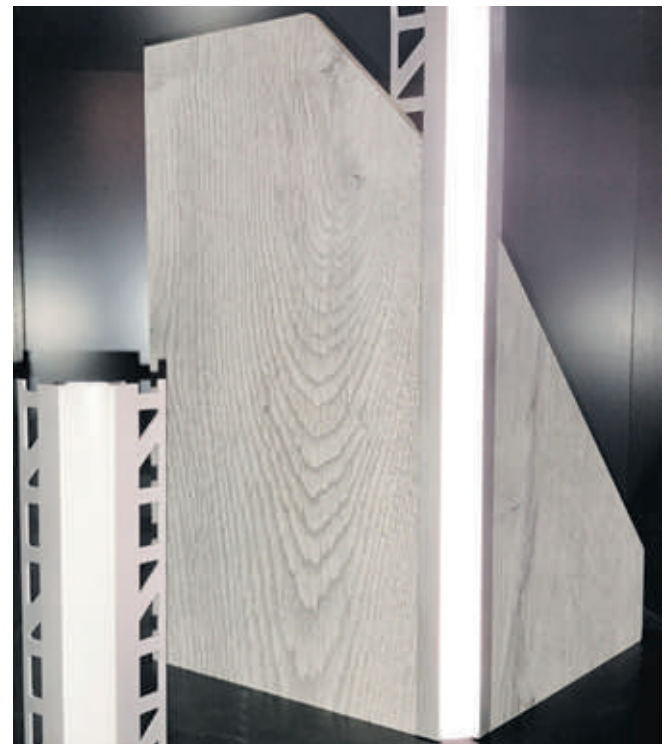

Aluminium alloy extrusion process in accordance with: ISO 9001:2008 - ISO 14001 / Tolerances defined by: UNE-EN 755-9 / UNE-EN 12020-2  
Theoretical weight: 0.356kg / Alloy: 6063 / Perimeter: 227.6mm / Anodising minimum: 15 microns  
Aluminium purity: 95-98% / Material treatment: T-5 / Covers: methacrylate (greater protection against UV rays)

# led profile by Luz Negra

## BALTIMORE

Our PROFESSIONAL led profile series is manufactured in high purity aluminium and available in silver anodised. This profile is ideal for illuminating bathrooms, kitchens and similar areas, where it is mounted on tiles, ceramic or stoneware surfaces. Also, due to its perforated L-shaped trims, it is easy to fit the profile into concrete in order to achieve a perfect adhesion to the wall. This profile is designed for inner corners.

It is suitable for led strips with a maximum width of 12.5mm and a power not greater than 20W/m. In order to obtain a more homogeneous illumination while also improving the dot free effect, we recommend combining it with our Canovelles-Barcelona-Gomera-COB ecoled strips.

**We offer a 2 year guarantee on our profiles and covers.**

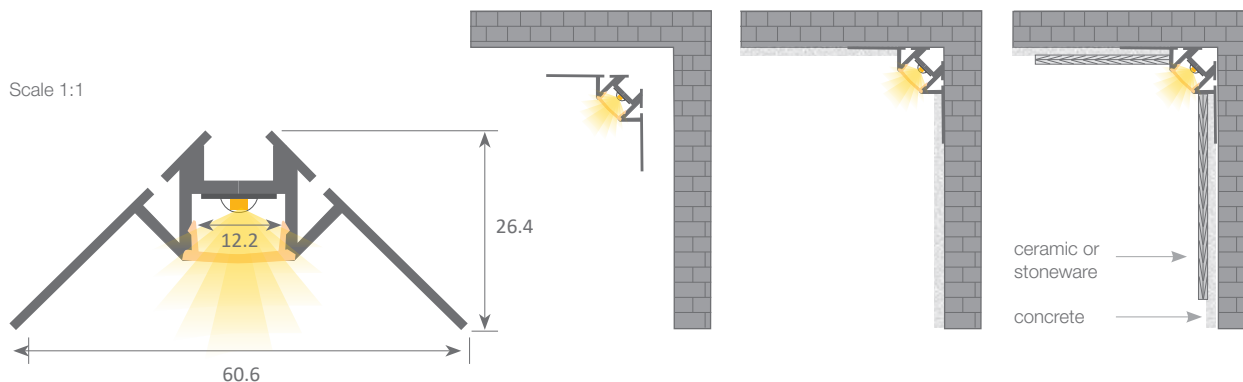

### Aluminium profile

08.002 anodised silver 3m



### Plastic endcaps

19.128 white without hole  
19.129 white with hole



### Polycarbonate cover

18.116 opal 2m  
18.146 frosted 2m  
18.148 opal 2m  
18.018 opal 3m  
18.115 opal 6m  
18.145 frosted 2m  
18.147 opal 2m



### Methacrylate cover

18.014 transparent 2m  
18.015 frosted 2m  
18.016 transparent 6m  
18.017 frosted 6m



Aluminium alloy extrusion process in accordance with: ISO 9001:2008 - ISO 14001 / Tolerances defined by: UNE-EN 755-9 / UNE-EN 12020-2  
Theoretical weight: 0.423kg / Alloy: 6063 / Perimeter: 238.7mm / Anodising minimum: 15 microns  
Aluminium purity: 95-98% / Material treatment: T-5 / Covers: methacrylate (greater protection against UV rays)

led profiles for walls







KENTUCKY

136



WASHINGTON

137



CLEVELAND

138



BURDEOS

140



ATLANTA SLIM

141



VENEZIA

142



MÓNACO

143



GALICIA

144



COMENZA  
PASAMANOS

146



TALLIN

149A

# led profile by Luz Negra

Our PROFESSIONAL led profile series is manufactured in high purity aluminium and available in silver anodised. The profile is suitable for corridors and walls, where it offers Up&Down led lighting. Suitable for led strips with a maximum width of 12mm and a power not greater than 20W/m. In order to obtain a more homogeneous illumination, while also improving the dot free effect, we recommend combining it with our Canovelles-Barcelona-Gomera-COB ecoled led strips. **We offer a 2 year guarantee on our profiles and covers.**

## KENTUCKY



**Aluminium profile**  
09.005 anodised silver 3m



**Aluminium endcaps**  
19.141 without hole



**Polycarbonate cover**  
18.063 opal 3m



**Clip**  
20.024 chrome steel

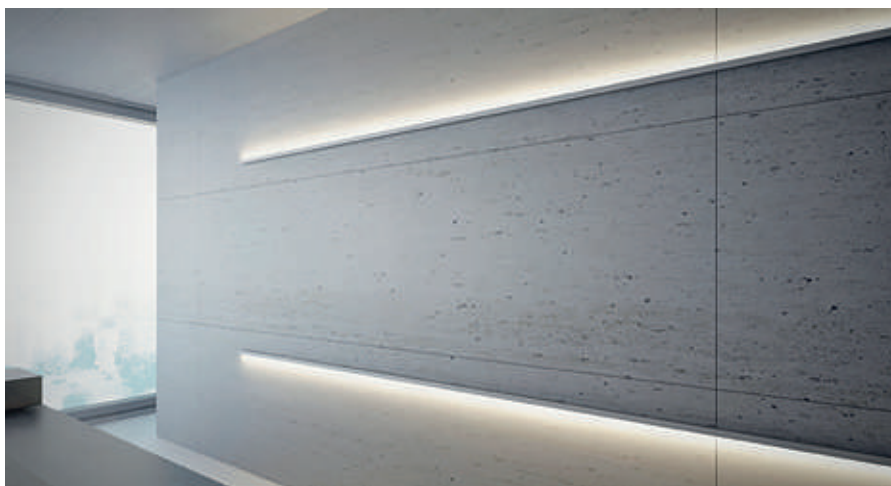
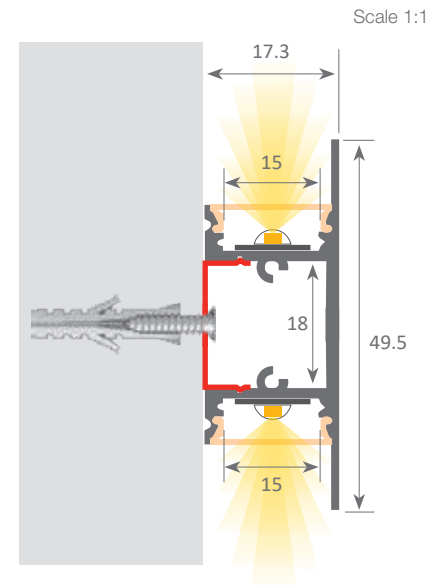

Option: aluminium skirting board



Aluminium alloy extrusion process in accordance with: ISO 9001:2008 - ISO 14001 / Tolerances defined by: UNE-EN 755-9 / UNE-EN 12020-2  
Theoretical weight: 0.320kg / Alloy: 6063 / Perimeter: 135.5mm / Anodising minimum: 15 microns  
Aluminium purity: 95-98% / Material treatment: T-5 / Covers: Fireproof V0

# led profile by Luz Negra

Our PROFESSIONAL led profile series is manufactured in high purity aluminium and available in silver anodised, white lacquered or black lacquered. The profile is suitable for aisles and walls, where it offers Up&Down led lighting. Its central channel houses the power supply and allows the cables to pass through for the circuit's closure, therefore reducing steep voltage drops.

Suitable for led strips with a maximum width of 25mm and a power not greater than 40W/m.

In order to obtain a more homogeneous illumination, while also improving the dot free effect, we recommend combining it with our Canovelles-Barcelona-Gomera-COB ecoled led strips. It can also be used with our rigid led strips.

**We offer a 2 year guarantee on our profiles and covers.**

## WASHINGTON



### Aluminium profile

09.006	anodised silver	3m
09.054	white lacquered	3m
09.055	black lacquered	3m



### Polycarbonate cover

18.064	opal	3m
--------	------	----



### Plastic endcaps

19.142	grey without hole
19.136	white without hole
19.137	black without hole



### Clip

20.025	chrome steel
--------	--------------

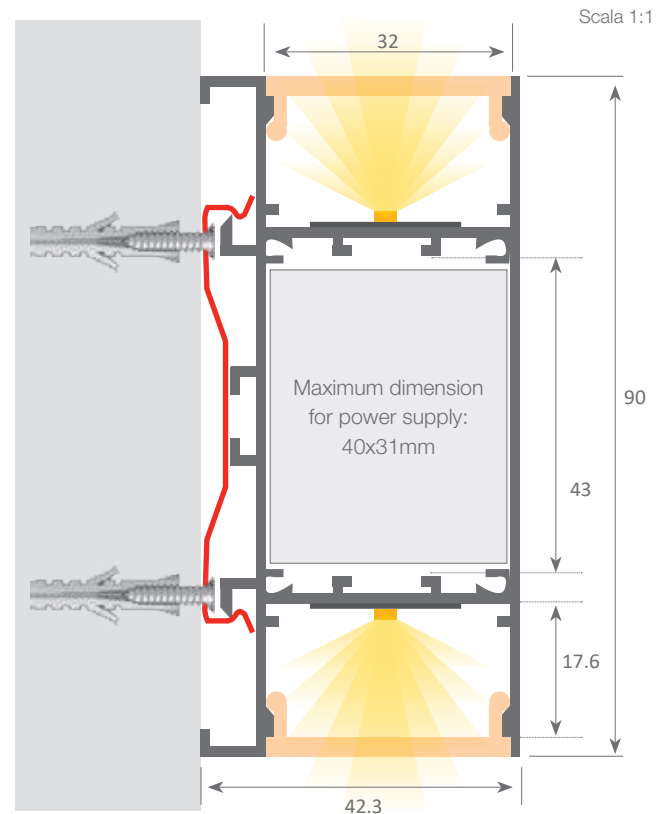

Aluminium alloy extrusion process in accordance with: ISO 9001:2008 - ISO 14001  
Tolerances defined by: UNE-EN 755-9 / UNE-EN 12020-2 / Theoretical weight: 1.450kg / Alloy: 6063  
Perimeter: 641.4mm / Anodising minimum: 15 microns / Aluminium purity: 95-98% / Material treatment: T-5 / Covers: Fireproof V0

# led profile by Luz Negra

## CLEVELAND

Our BASIC led profile series is manufactured in high purity aluminium and available in silver anodised. It is ideal for indirectly lighting up aisles and walls. It can also be used in drywalls and between wooden panels to indirectly light upwards and downwards.

Suitable for led strips with a maximum width of 12mm and a power not greater than 20W/m.

In order to obtain a more homogeneous illumination, while also improving the dot free effect, we recommend combining it with our ecoled Canovelles-Barcelona-Gomera-COB ecoled strips.

**We offer a 2 year guarantee.**

Scale 1:1

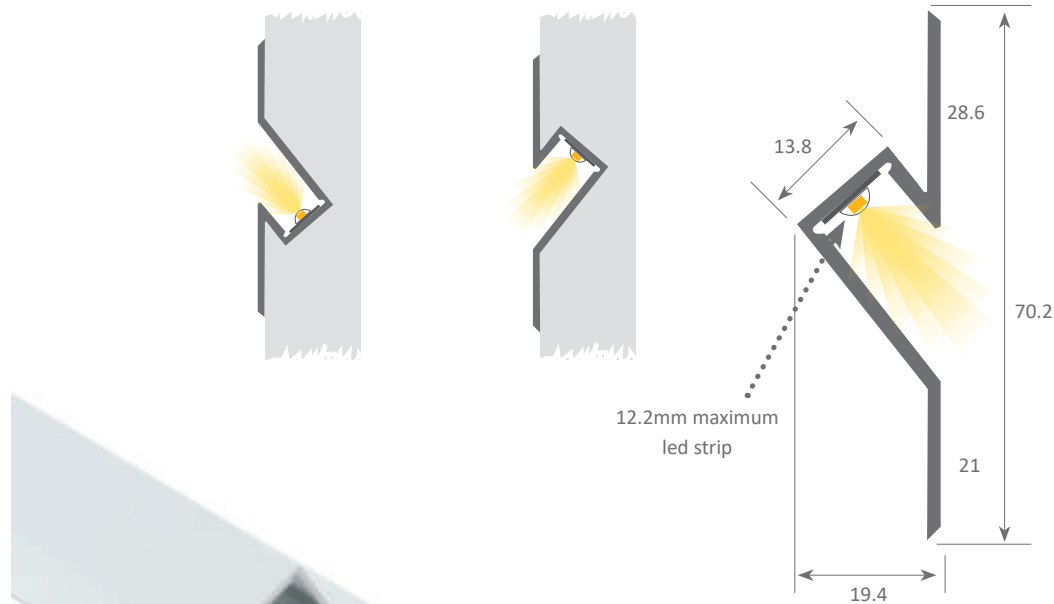

### Aluminium profile

09.004 anodised silver 3m



### Plastic endcaps

19.139 grey without hole

19.140 grey with hole

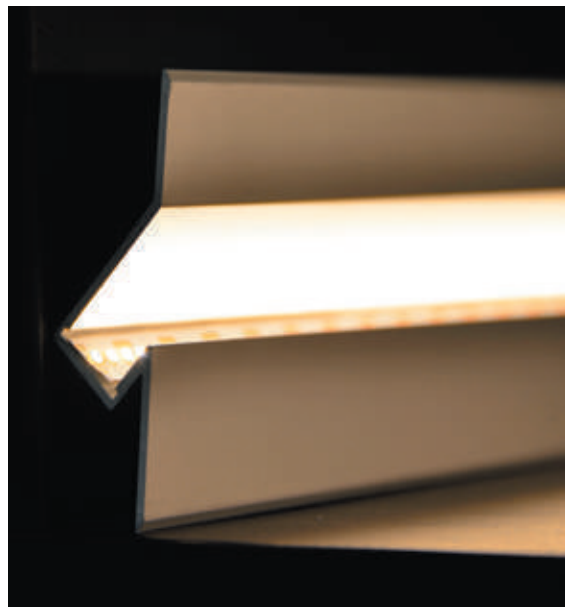

Aluminium alloy extrusion process in accordance with: ISO 9001:2008 - ISO 14001 / Tolerances defined by: UNE-EN 755-9 / UNE-EN 12020-2  
Theoretical weight: 0.426kg / Alloy: 6063 / Perimeter: 201.4mm / Anodising minimum: 15 microns  
Aluminium purity: 95-98% / Material treatment: T-5 / Covers: Fireproof V0



# led profile by Luz Negra

Our BASIC led profile series is manufactured in white plastic and does not require a cover. It is ideal for indirectly lighting up furniture and display units.

Once mounted, the profile can also be used between wooden panels to indirectly light upwards and downwards.

Suitable for led strips with a maximum width of 10mm and a power not greater than 16W/m. In order to obtain a more homogeneous illumination, we recommend combining it with our Cies ecoled strip.

**We offer a 2 year guarantee.**

## BURDEOS

Scale 1:2

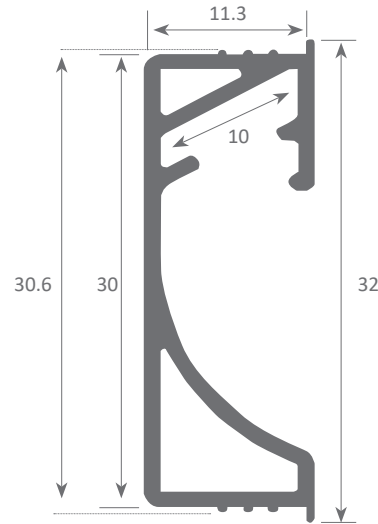
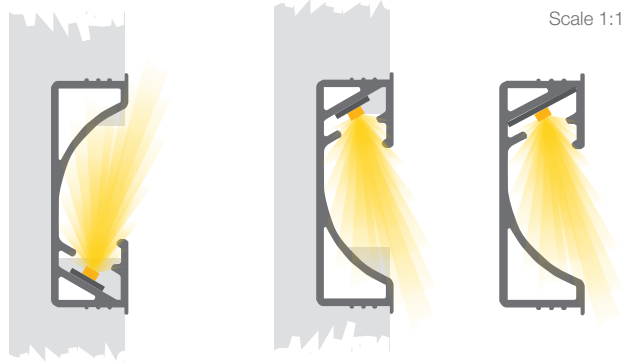
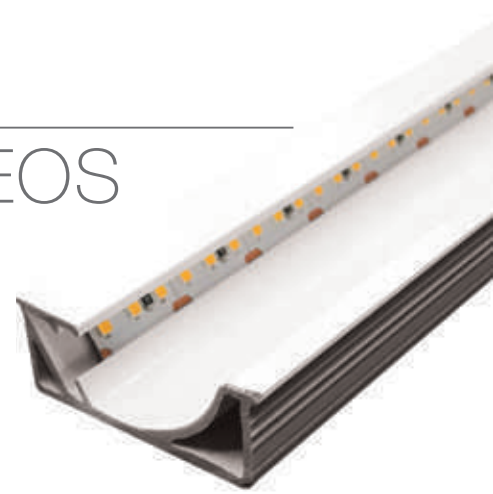

**Plastic profile**

09.003 white

2.60m



# led profile by Luz Negra

Our BASIC led profile series is manufactured in high purity aluminium and available in silver anodised. It is ideal for indirect lighting in walls and ceilings. It can be integrated into the wall, plasterboard or wooden panels to indirectly light upwards or downwards.

Suitable for led trips with a maximum width of 12mm and a power not greater than 20W/m. We recommend combining it with COB our Elite ecoled strip in order to achieve an homogeneous illumination, while also improving the dot free effect.

**We offer a 2 year guarantee on our profiles and covers.**

## ATLANTA SLIM

Scale 1:1

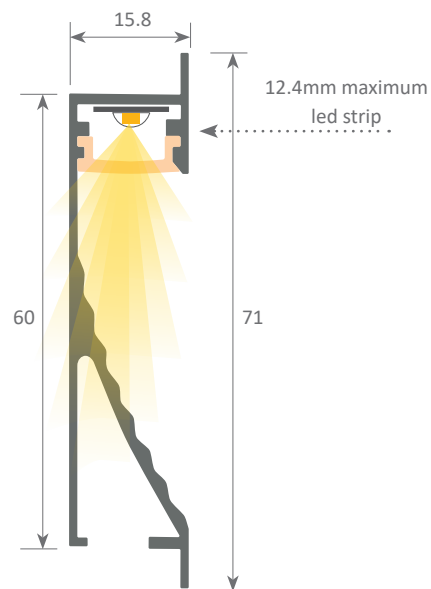

For use as skirting board

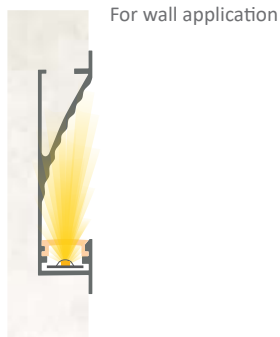

For wall application



### Aluminium profile

09.002 anodised silver 3m



### Plastic endcaps

19.138 white left (with hole) set of 2 pieces  
white right (without hole)



### Polycarbonate cover

18.062 opal 3m

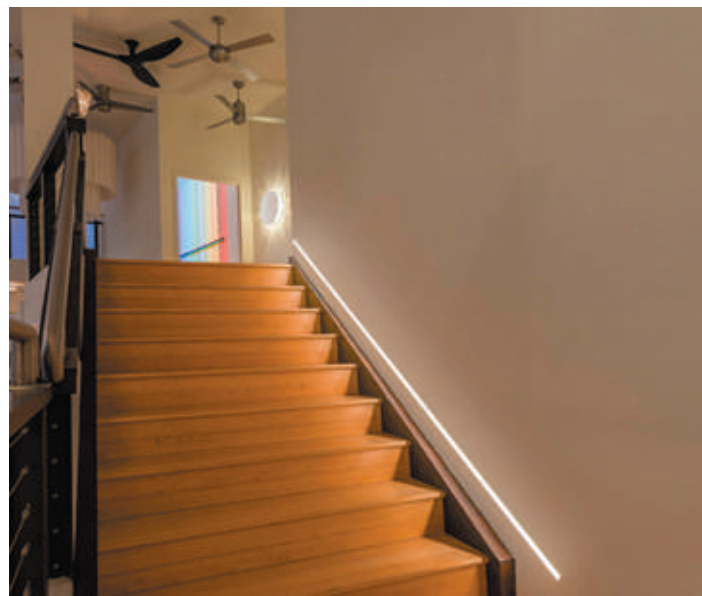

Aluminium alloy extrusion process in accordance with: ISO 9001:2008 - ISO 14001 / Tolerances defined by: UNE-EN 755-9 / UNE-EN 12020-2  
Theoretical weight: 0.380kg / Alloy: 6063 / Perimeter: 265mm / Anodising minimum: 15 microns  
Aluminium purity: 95-98% / Material treatment: T-5 / Covers: Fireproof V0

# led profile by Luz Negra

## VENEZIA

Our BASIC led profile series for wall applications is a folded aluminium profile and with a lacquered white finish. It is ideal for ceiling and ambience lighting. Drivers can be housed inside along with other types of cables, such as telephone, network or similar, allowing circuit closures and therefore avoiding voltage drops.

This profile is available in 2m lengths and suitable for using with our Vizcaya-Barcelona flexible ecoled strips.

**We offer a 2 year guarantee.**

Scale 1:1

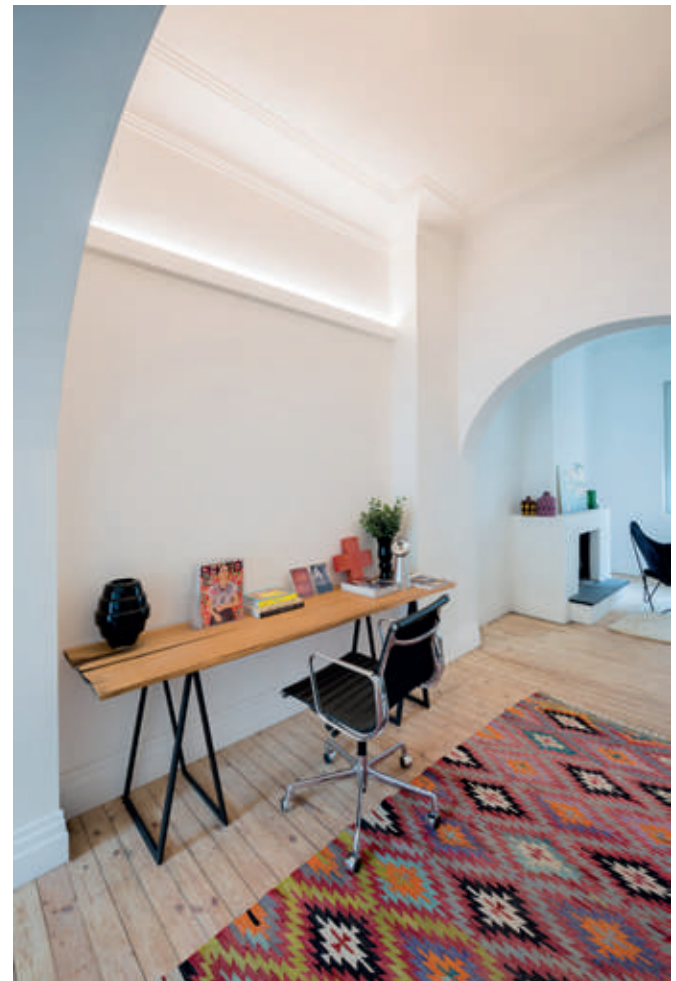
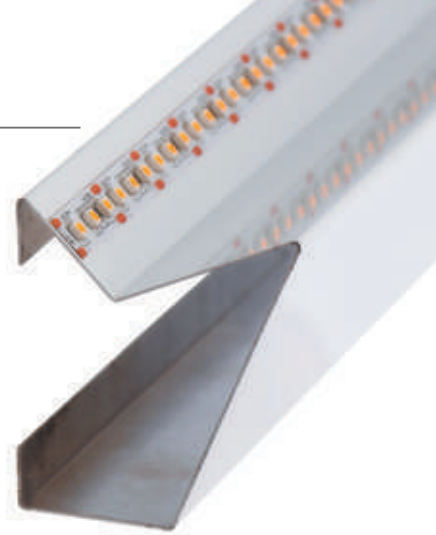
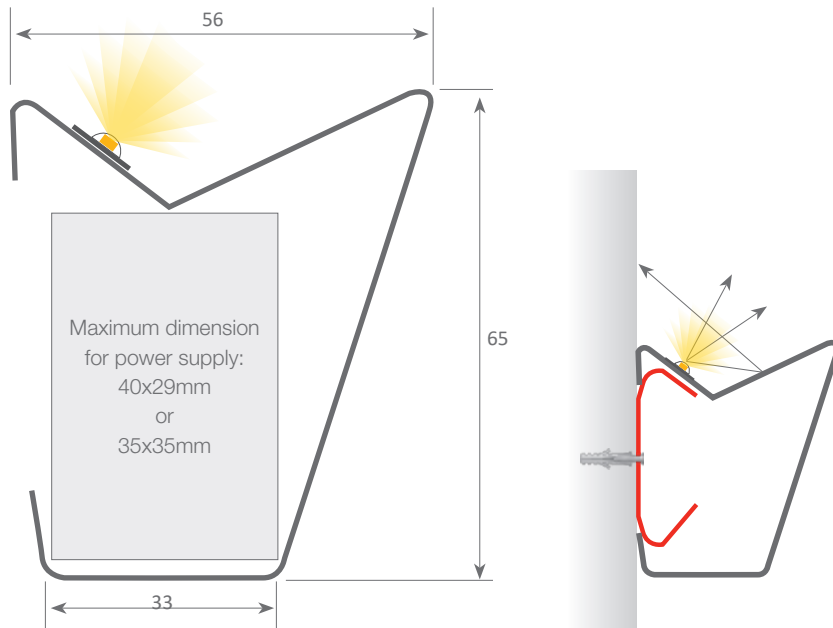

**Aluminium profile**

09.007 white

2m



**Plastic endcaps**

19.143 white left endcap

19.144 white right endcap



**Clip**

20.026 chrome steel



**Aluminum joint**

22.021 joint between profiles



**WARNING:**

As this is not an extruded profile (manually folded profile) there are some tolerances in the final external measurements (mm). The dimensions therefore in this technical drawing are approximate.



# led profile by Luz Negra

Our BASIC led profile series for wall and ceiling applications is a folded aluminium profile lacquered in white. It is ideal for ceilings, walls and ambience lighting. Drivers can be housed inside along with other types of cables, such as telephone, network or similar, allowing circuit closures and therefore avoiding voltage drops.

Profile available in 2m lengths and designed for use with flexible or rigid led strips (with a maximum width of 20mm).

**We offer a 2 year guarantee.**

## MONACO

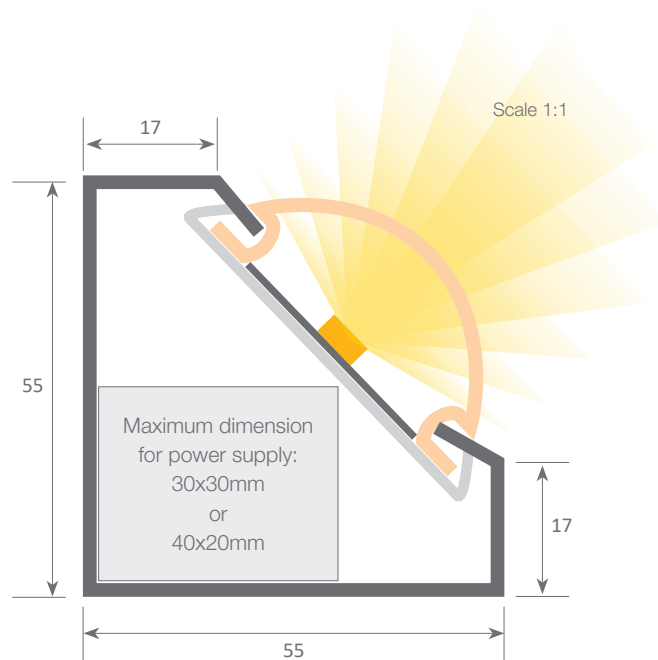

**Aluminium profile**  
09.008 white 2m



**PVC endcaps**  
19.145 white



**Aluminium profile**  
02.028 white 2m



**Methacrylate cover**  
18.040 frosted 2m



**WARNING:**

As this is not an extruded profile (manually folded profile) there are some tolerances in the final external measurements (mm). The dimensions therefore in this technical drawing are approximate.

# led profile by Luz Negra

## GALICIA

Our PROFESSIONAL led profile series is manufactured in high purity aluminium and available in silver anodised. The profile is suitable for corridors and walls.

Suitable for led strips with a maximum width of 12mm and a power not greater than 20W/m.

In order to obtain a more homogeneous illumination, while also improving the dot free effect, we recommend combining it with our Canovelles-Barcelona-Gomera-COB ecoled strips.

**We offer a 2 year guarantee on our profiles and covers.**

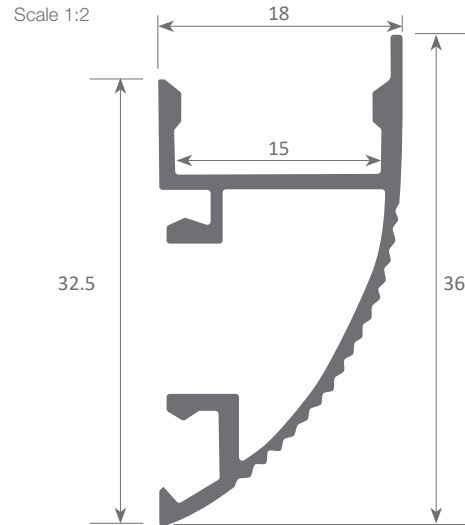

### Aluminium profile

09.047 lacquered white 3m  
09.048 lacquered silver 3m



### Plastic endcaps

19.348 white without right hole  
19.222 white without left hole  
19.322 white without right hole  
19.323 white without left hole



### Polycarbonate cover

18.083 opal 3m



### Clip

20.052 chrome steel

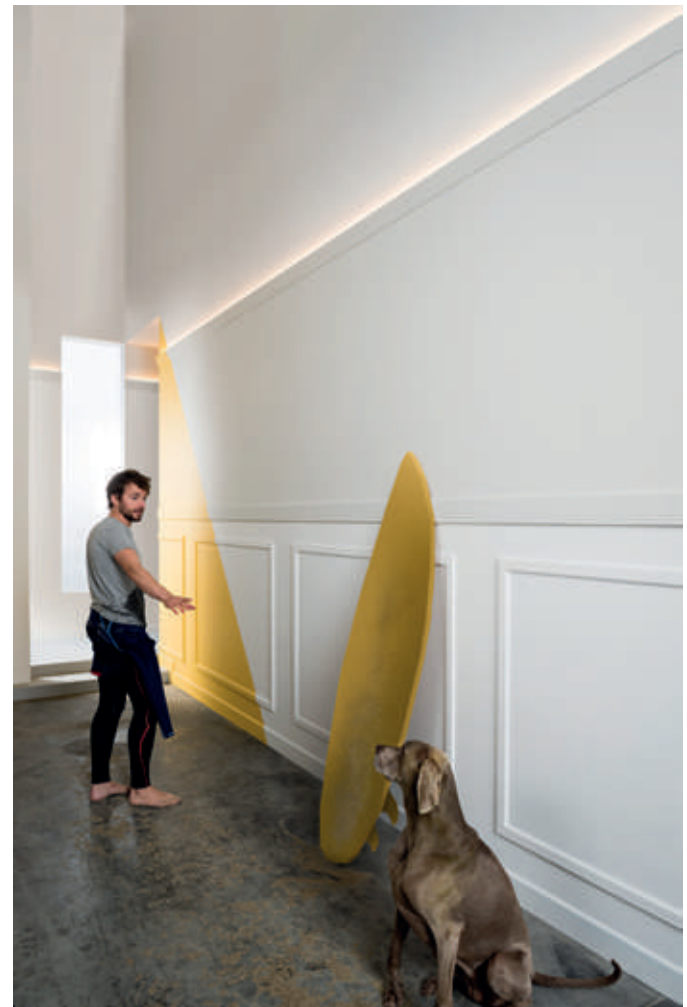

Aluminium alloy extrusion process in accordance with: ISO 9001:2008 - ISO 14001 / Tolerances defined by: UNE-EN 755-9 / UNE-EN 12020-2  
Alloy: 6063 / Anodising minimum: 15 microns  
Aluminium purity: 95-98% / Material treatment: T-5 / Covers: Fireproof V0



# led profile by Luz Negra

Our PROFESSIONAL led profile series for handrails, manufactured in stainless steel is supplied along with its components, on request. This profile allows us to incorporate led lighting, using our Versailles led profile (recommended option) or our Philadelphia led profile.

We also offer a wide range of accessories such as wall supports, joints, end caps and open/closed elbow joints.

This steel profile is available in 5m lengths, which allows us to carry out long installations. Suitable for led strips with a maximum width of 12mm and a power not greater than 20W/m. In order to obtain a more homogeneous illumination, we recommend using our opal cover along with our ecoled strips, Canovelles-Barcelona-Gomera-COB.

**We offer a 2 year guarantee.**

## COMENZA HANDRAIL

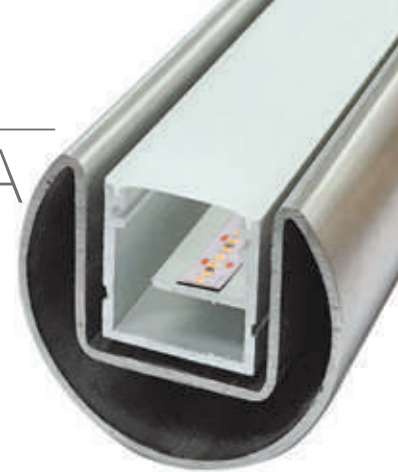

Scale 1:1

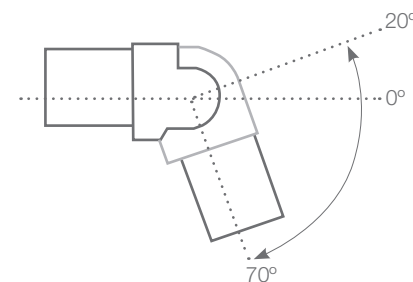
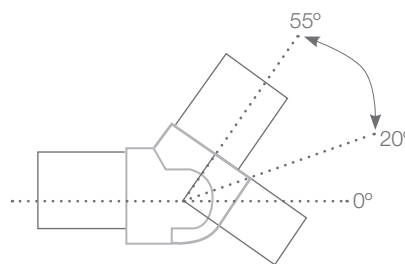
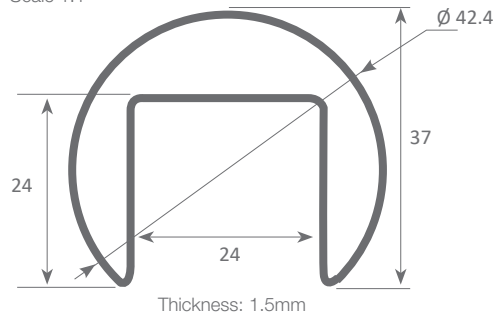

### Stainless steel profile

- 12.008 polished stainless steel 5m
- 12.008 polished stainless steel "satin finish" 5m



### Corner connector

- 22.026 polished stainless steel
- 22.026 polished stainless steel "satin finish"



### Wall support

- 22.027 polished stainless steel
- 22.027 polished stainless steel "satin finish"



### Adjustable connector

- 22.028 polished stainless steel
- 22.028 polished stainless steel "satin finish"



### Adjustable connector 55° / 20°

- 22.029 polished stainless steel
- 22.029 polished stainless steel "satin finish"



### Joint

- 22.030 polished stainless steel
- 22.030 polished stainless steel "satin finish"



### Closing endcap

- 19.152 polished stainless steel
- 19.152 polished stainless steel "satin finish"



Regulations: Technical Building Code TBC by Applus  
Handrail diameter: Ø 42mm / AISI 316 Stainless steel - resistant to corrosion and high temperatures



COMENZA led profile

## COMENZA HANDRAIL

Its inner channel allows the cables to pass through the circuit's closure

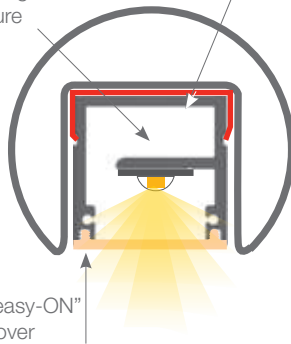

IP65 "easy-ON" cover



It can be illuminated when combined with our Versalles or Philadelphia led profiles.

"20.030" clamps

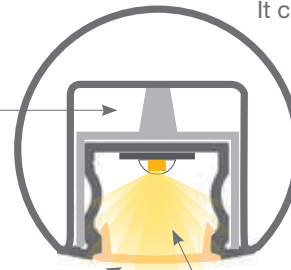

Methacrylate cover

Philadelphia led profile with 20.030 aluminium clamps



### Philadelphia led profile

04.009	anodised silver	2m
04.010	white lacquered	2m
04.011	raw	2m
04.012	anodised silver	6m
04.013	white lacquered	6m
04.014	raw	6m



### Versalles led profile

02.018	anodised silver	2m
02.019	anodised black	2m
02.020	anodised silver	6m
02.021	anodised black	6m



### Internal handrail clamp

20.030	aluminium
--------	-----------



### Clip for Versalles led profile

20.009	chrome steel
20.010	black oxide finish



### Polycarbonate cover

18.116	opal	2m
18.146	frosted	2m
18.148	opal	2m
18.018	opal	3m
18.115	opal	6m
18.145	frosted	2m
18.147	opal	2m



### Methacrylate cover

18.014	transparent	2m
18.015	frosted	2m
18.016	transparent	6m
18.017	frosted	6m



### Versalles cover

18.022	transparent	2m
18.023	opal	2m
18.024	frosted	2m
18.025	transparent	6m
18.026	opal	6m
18.027	frosted	6m



18.030	lens	2m
18.031	lens	6m





COMENZA led profile

# led profile by Luz Negra

## TALLIN

Our BASIC led profile series for ceilings and walls is manufactured in high purity aluminium and available in white. This profile is designed to be used in ceilings or walls, offering an easy and elegant perimetral lighting. This is perfect for concealing the edges in false ceilings. Suitable for led strips with a maximum width of 12mm and a power not greater than 20W/m. We recommend our COB or Elite ecoled strips in order to achieve a homogeneous lighting, while also improving the dot free effect.

**We offer a 2 year guarantee on our profiles and covers.**

Scale 1:1

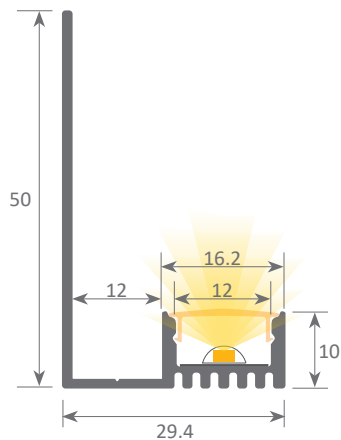

### Aluminium profile

08.032 white 3m



### Plastic endcaps

19.169 white with hole set of 2 pieces  
white without hole



### Polycarbonate cover

18.119 opal 3m





led profiles for shelving and signage

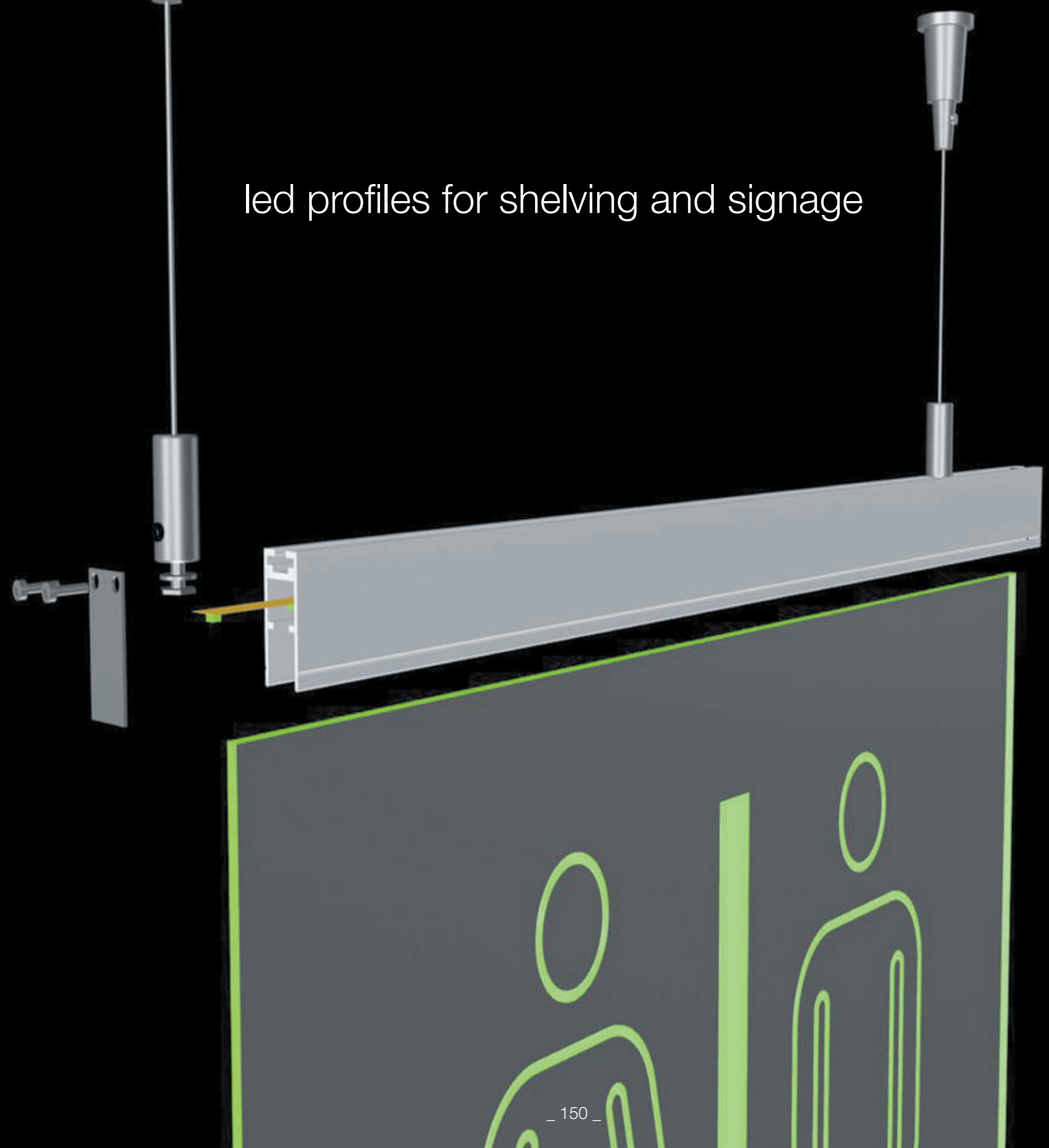



HANNOVER

152



GINEBRA

154



COLONIA

155



PLEXILED  
SLIM

156



PLEXILED

157



A03

158



PLETINA

159



ALFA 2

160



MONTECARLO

161



BONIN

161A

Our PROFESSIONAL led profile series is manufactured in high purity aluminium and silver anodised. This profile can be used for many different purposes, such as ceilings and signage, due to its ultra thin methacrylate with optical effect.

Its etched methacrylate surface makes it ideal for hanging (display signs). We can also manufacture hanging or wall-based luminaires, both with Up&Down or side lighting. Its use with glass or methacrylate converts it into a practical illuminated shelf.

Suitable for led strips with a maximum width of 11mm and a power not greater than 30W/m. We recommend using it with COB our Granada ecoled strip in order to obtain intense brightness.

**We offer a 10 year guarantee.**



Scale 1:1

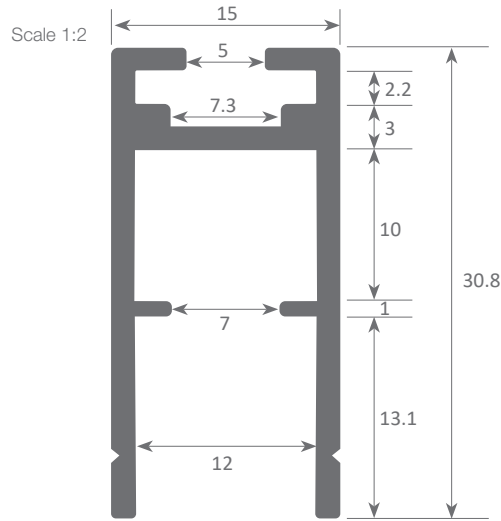
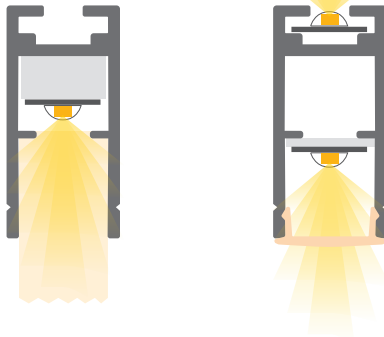

### Aluminium profile

12.001	anodised silver	3m
12.002	anodised silver	6m



### Endcaps

19.146	silver aluminium with hole
19.147	plastic without hole



### 90° angle bracket

22.003	steel
--------	-------



### Hanger cable

21.001	chrome	set of 2 units
21.002	white	set of 2 units
21.003	black	set of 2 units (clip not included)



### Polycarbonate cover

18.116	opal	2m
18.146	frosted	2m
18.148	opal	2m
18.018	opal	3m
18.115	opal	6m
18.145	frosted	2m
18.147	opal	2m



### Methacrylate cover

18.014	transparent	2m
18.015	frosted	2m
18.016	transparent	6m
18.017	frosted	6m



### Bracket

22.022	aluminium
--------	-----------

Shelf illumination with optic methacrylate and led

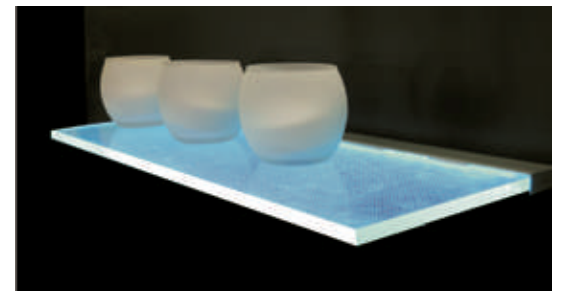

Aluminium alloy extrusion process in accordance with: ISO 9001:2008 - ISO 14001 / Tolerances defined by: UNE-EN 755-9 / UNE-EN 12020-2  
Theoretical weight: 0.357kg / Alloy: 6063 / Perimeter: 173mm / Anodising minimum: 15 microns  
Aluminium purity: 95-98% / Material treatment: T-5

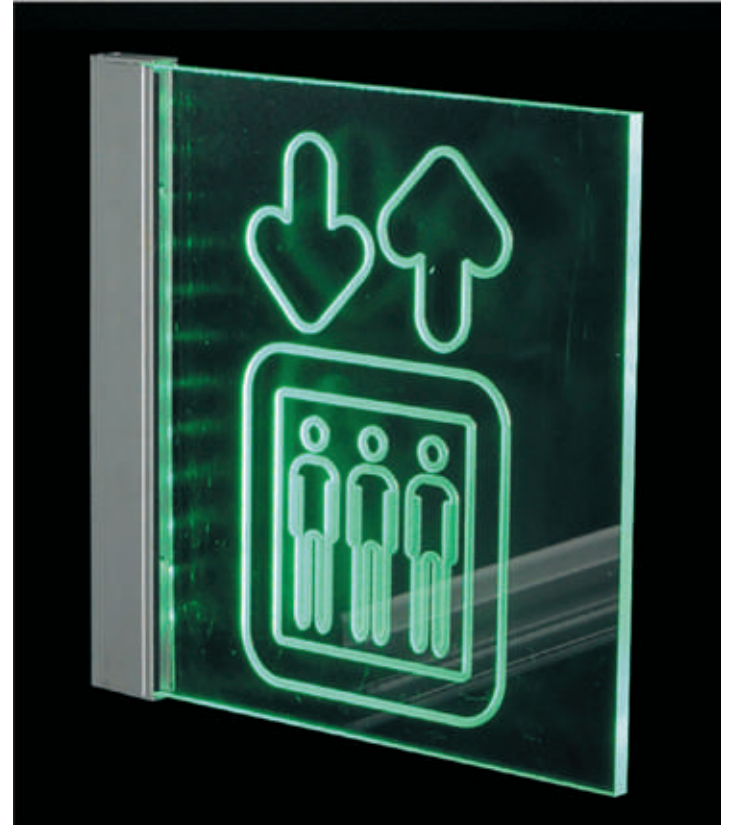
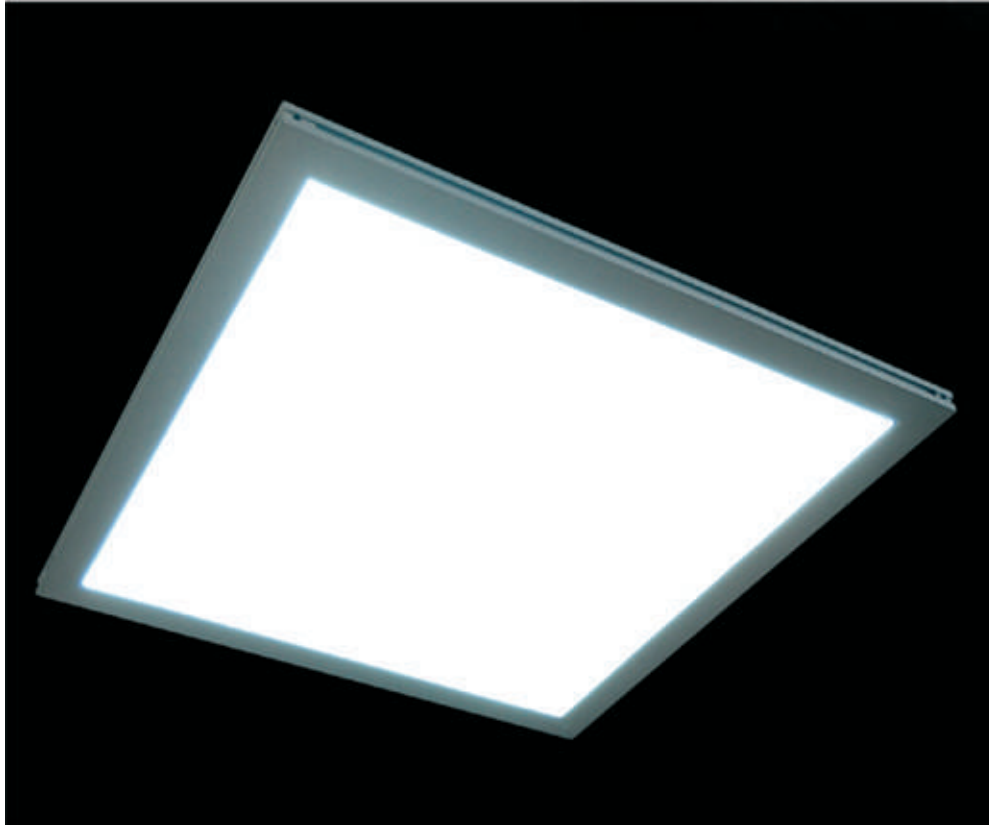
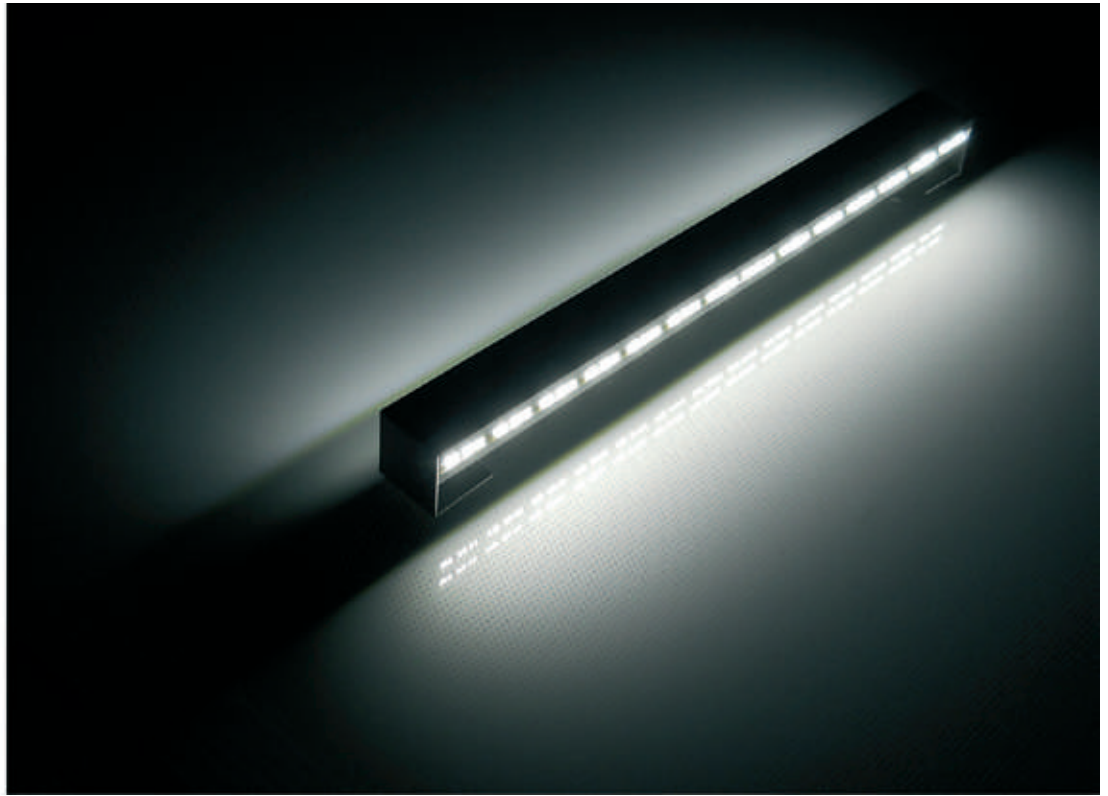

# led profile by Luz Negra

Our PROFESSIONAL led profile series is manufactured in high purity aluminium and silver anodised. This profile can be used for many different purposes, such as wall or table signage, due to its etched methacrylate surface (display signs with diffused lighting).

We can also use it as an illuminated shelf with glass or methacrylate.

Suitable for led strips with a maximum width of 15mm and a power not greater than 20W/m.

We recommend using it with our Avila ecoled strip in order to obtain white or coloured illumination.

**We offer a 10 year guarantee.**

## GINEBRA

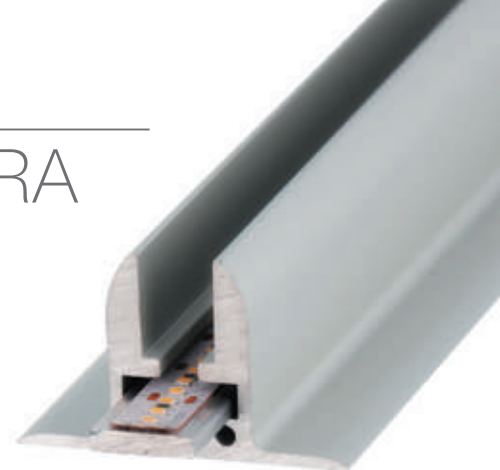

Scale 1:1

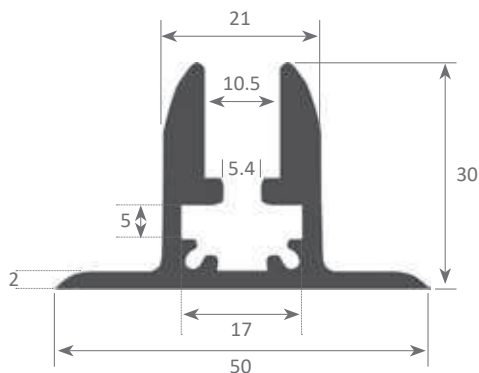

**Aluminium profile**  
12.003 anodised silver 3m



**Endcaps**  
19.149 grey plastic

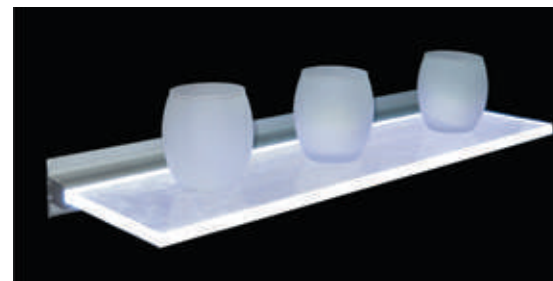

**Inner plate**  
12.017 aluminium  
1000x15x3mm



Aluminium alloy extrusion process in accordance with: ISO 9001:2008 - ISO 14001 / Tolerances defined by: UNE-EN 755-9 / UNE-EN 12020-2  
Theoretical weight: 0.910kg / Alloy: 6063 / Perimeter: 236mm / Anodising minimum: 15 microns  
Aluminium purity: 95-98% / Material treatment: T-5

# led profile by Luz Negra

Our PROFESSIONAL led profile series for surface applications, is manufactured in high purity aluminium, available in silver anodised and ideal for indirect lighting.

Suitable for use with led strips with a maximum width of 5mm such as our Granada or Cíes ecoled strips. It is designed to house 5mm optic methacrylate in order to achieve a luminous panel.

**We offer a 10 year guarantee.**

## COLONIA

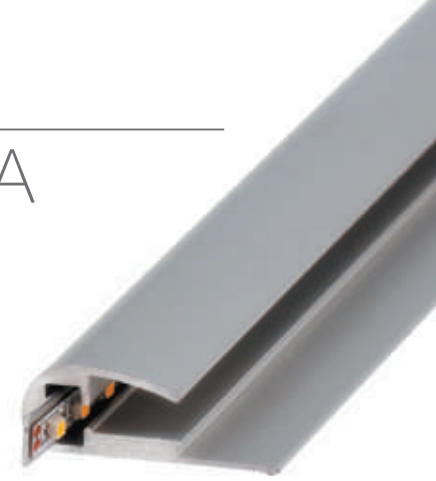

Escala 1:1

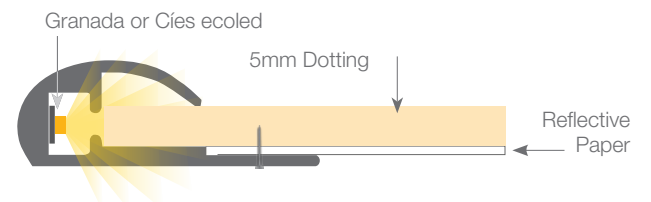
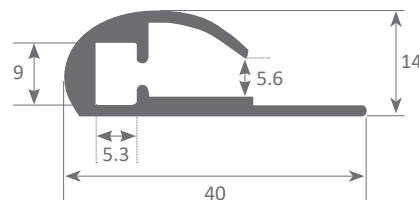

**Aluminium profile**  
12.016 anodised silver 3m



**Endcap**  
19.153 black plastic



**Adhesive magnet**  
42.001 12mm 1m

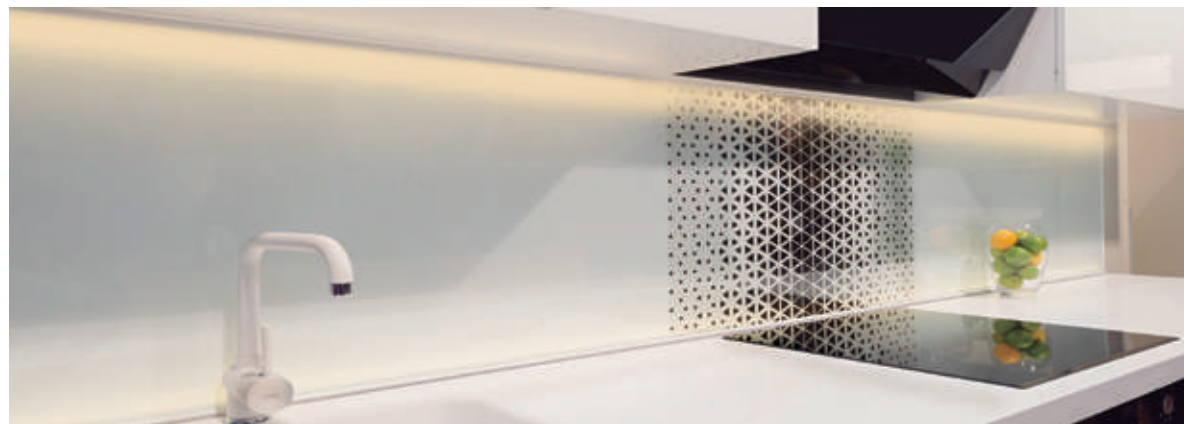

Aluminium alloy extrusion process in accordance with: ISO 9001:2008 - ISO 14001  
Tolerances defined by: UNE-EN 755-9 / UNE-EN 12020-2 / Theoretical weight: 462.5kg  
Alloy: 6063 / Perimeter: 135.3mm / Anodising minimum: 15 microns / Aluminium purity: 95-98% / Material treatment: T-5

Our BASIC led profile series is manufactured in high purity aluminium and available in silver anodised. This profile is a good provider of heat dissipation and can be used for walls and furniture applications, where the led strips are fixed to the sides. Moreover, it also offers upward and downward lighting. Suitable for led strips with a maximum width of 5mm, such as our Granada or Cies ecoled strips. It is mainly used as a heat dissipating plate for led panels, combined with our PLEXILED optic methacrylate.

**We offer a 2 year guarantee.**

## PLEXILED SLIM



Scale 1:1

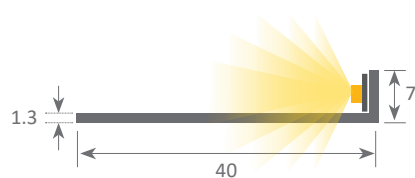

### Aluminium profile

12.013 anodised silver 3m



### Adhesive magnet

42.001 12mm 1m



### Adhesive tape

42.002 double-sided adhesive tape (50x12mm)  
42.003 double-sided adhesive foam tape (50x12mm)

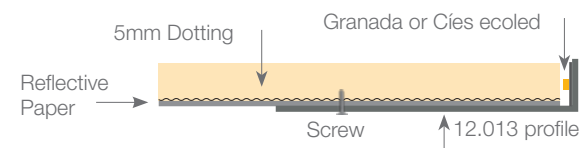
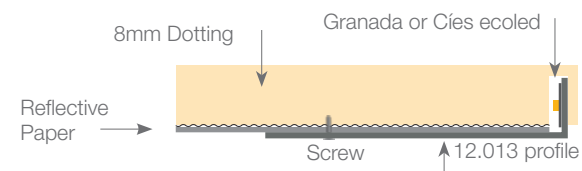

Aluminium alloy extrusion process in accordance with: ISO 9001:2008 - ISO 14001 / Tolerances defined by: UNE-EN 755-9 / UNE-EN 12020-2  
Theoretical weight: 0.161kg / Alloy: 6063 / Perimeter: 0.094mm / Anodising minimum: 15 microns  
Aluminium purity: 95-98% / Material treatment: T-5

## PLEXILED

Our BASIC led profile series is manufactured in high purity aluminium and available in silver anodised. This profile is a good provider of heat dissipation and can be used for walls and furniture applications, where the led strips are fixed to the sides. Moreover, it also offers upward and downward lighting. Suitable for led strips with a maximum width of 5mm, such as our Granada-Cies ecoled strips. It is mainly used as a heat dissipating plate for led panels, combined with our PLEXILED optic methacrylate.

**We offer a 2 year guarantee.**

Scale 1:1

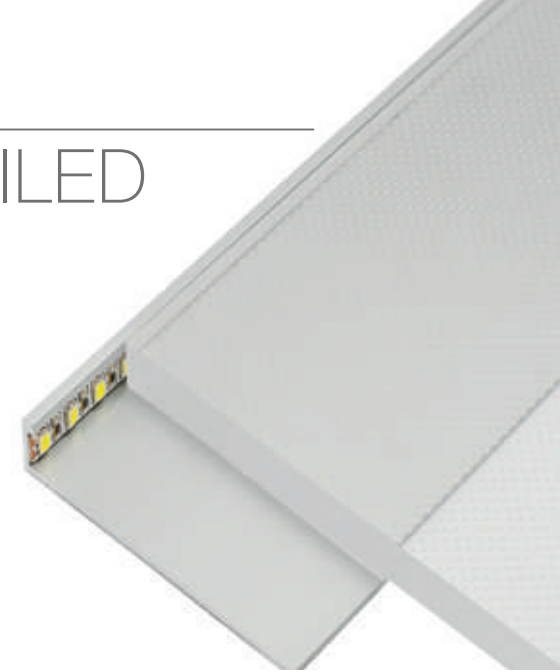
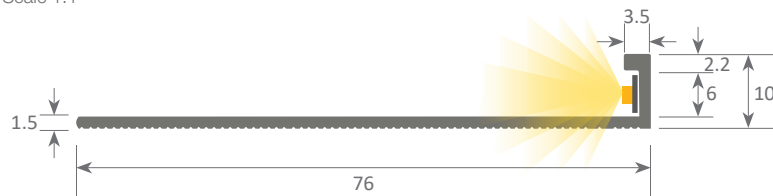

### Plexiled profile

12.006	anodised silver	2m
12.007	anodised silver	6m

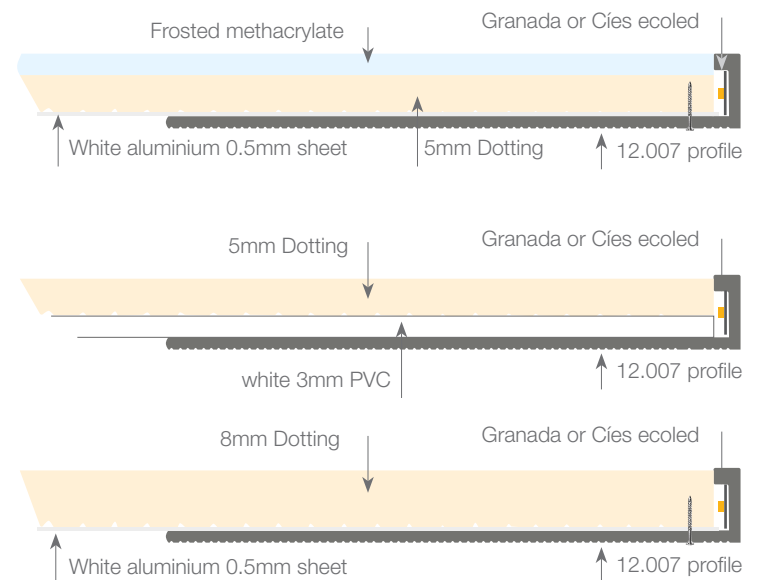



# led profile by Luz Negra

Our BASIC led profile series is manufactured in high purity aluminium and available in silver anodised. This profile is a good provider of heat dissipation and can be used for walls and furniture applications, where the led strips are fixed to the sides. Moreover, it also offers upward and downward lighting. Suitable for led strips with a maximum width of 12mm and a power not greater than 20W/m. We recommend using it with our Canovelles-Barcelona-Gomera-COB ecoled strip.

**We offer a 2 year guarantee.**

## A03



Scale 1:1

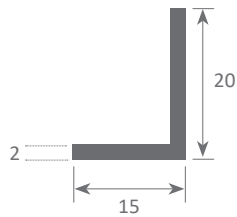

### Aluminium profile

12.009	anodised silver	6m
12.010	white lacquered	6m
12.011	black lacquered	6m
12.012	raw	6m



### Adhesive magnet

42.001	12 mm	1m
--------	-------	----



Aluminium alloy extrusion process in accordance with: ISO 9001:2008 - ISO 14001 / Tolerances defined by: UNE-EN 755-9 / UNE-EN 12020-2  
Theoretical weight: 0.178kg / Alloy: 6063 / Perimeter: 69.35mm / Anodising minimum: 15 microns  
Aluminium purity: 95-98% / Material treatment: T-5

# led profile by Luz Negra

Our BASIC led profile series which is manufactured in high purity raw aluminium. This is an economic alternative for applying minimum dissipation to a led strip.

Suitable for use with led strips with a maximum width of 15mm and a power not greater than 20W/m. We recommend using it with our Canovelles-Barcelona-Gomera-COB ecoled strip.

**We offer a 2 year guarantee.**

## PLETINA



Scale 1:1

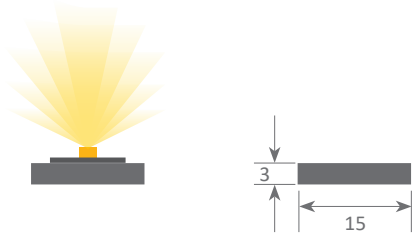

**Aluminium profile**  
12.017 raw (1000x15x3mm)



**Aluminium profile**  
22.189 raw (1000x15x3mm)



**Aluminium profile**  
22.191 raw (1000x15x3mm)



**Aluminium profile**  
22.190 raw (1000x15x3mm)



**Adhesive magnet**  
42.001 12mm 1m



# led profile by Luz Negra

## ALFA 2

Our PROFESSIONAL led profile series is manufactured in high purity aluminium and silver anodised. The profile is composed of a base and a lid, joined together by means of a spring effect plate (all supplied separately). This has been designed for manufacturing ultra thin display signs in methacrylate optic with side lighting.

The profile/cover can be lifted up allowing us to easily change the advertisement in a question of minutes.

We recommend using it with our Granada ecoled strip or similar.

**We offer a 10 year guarantee.**



Scale 1:1

Foldable front panel

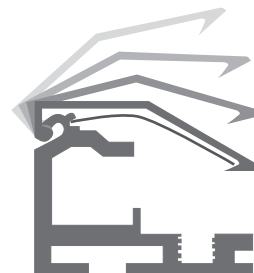
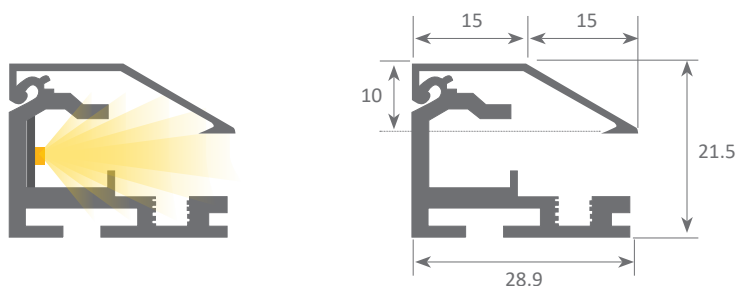

### Aluminium profile

12.004 anodised silver 3m  
12.005 anodised silver 6m

### Bracket

22.025 aluminium

### Plate

22.024 steel spring

### Foldable front panel

19.150 anodised silver 3m  
19.151 anodised silver 6m



Aluminium alloy extrusion process in accordance with: ISO 9001:2008 - ISO 14001 / Tolerances defined by: UNE-EN 755-9 / UNE-EN 12020-2  
Theoretical weight: 0.549kg / Alloy: 6063 / Perimeter: 186mm / Anodising minimum: 15 microns  
Aluminium purity: 95-98% / Material treatment: T-5

Our PROFESSIONAL led profile series is manufactured in high purity aluminium and available in silver anodised. It is ideal for the manufacturing of extremely thin luminous panels for ceilings or advertising displays.

We recommend using it with our Granada ecoled strip and designed to house optic methacrylate.

**We offer a 10 year guarantee.**



Scale 1:2

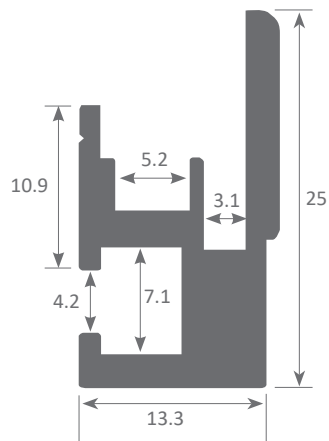

Scale 1:1



8mm Methacrylate

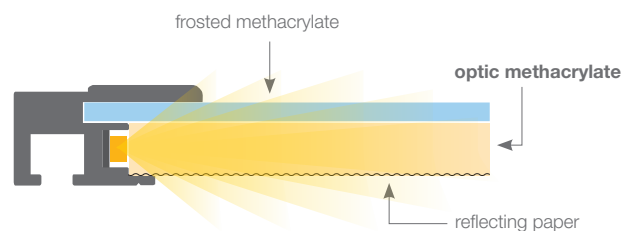

### Aluminium profile

12.014 anodised silver 6m  
12.015 anodised white 6m



### Profile joint

22.005 steel



### 90° angle bracket

22.003 steel



### Hanger cable

21.001 chrome set of 2 units  
21.002 white set of 2 units  
21.003 black set of 2 units  
(clip not included)

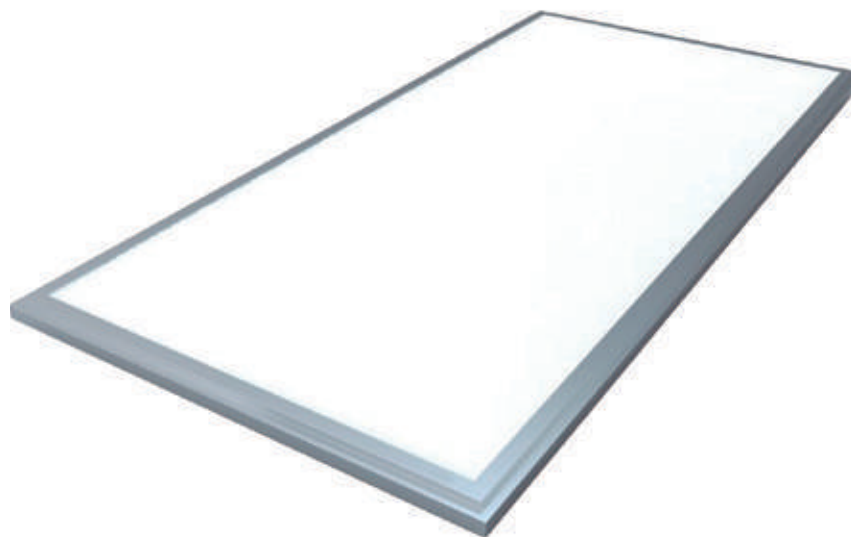

Aluminium alloy extrusion process in accordance with: ISO 9001:2008 - ISO 14001 / Tolerances defined by: UNE-EN 755-9 / UNE-EN 12020-2  
Theoretical weight: 0.408kg / Alloy: 6063 / Perimeter: 123mm / Anodising minimum: 15 microns  
Aluminium purity: 95-98% / Material treatment: T-5

# led profile by Luz Negra

## BONN

Our PROFESSIONAL led profile series is manufactured in high purity aluminium and available in anodised black.

It is ideal for using with furniture, shelving or similar as it offers up and down lighting. Both profile and covers are available in lengths of 1m.

Suitable for led strips with a maximum width of 5mm and a power not greater than 15W/m.

We recommend using with our COB ecoled strips to achieve a more homogeneous and diffused illumination.

**We offer a 5 year guarantee.**

Scale 1:1

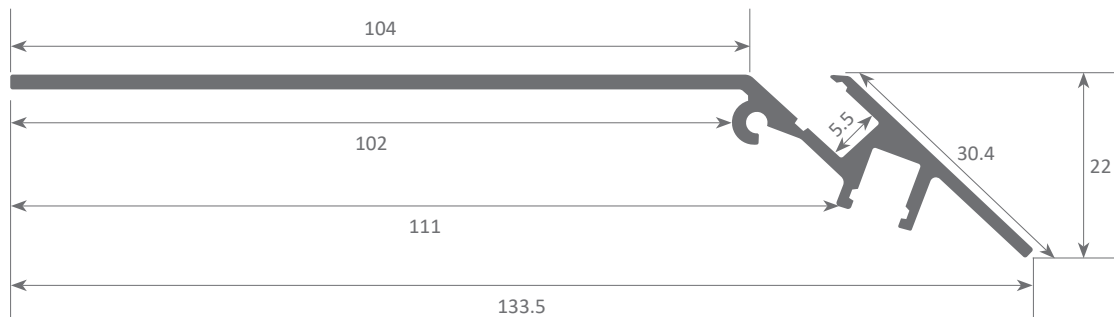

### Aluminium profile

12.022 black anodised 1m



### Polycarbonate cover

18.137 frosted 1m



### Plastic endcaps

19.433 blank without hole (left)

19.434 blank without hole (right)





flexible  
led profiles



MILANO SLIM

164



HARMONY

166



HARMONY XS

168



MONTRY

170



CANNES

170



LILLE

170



ARLES

170



ESBLY

170



AVIÑÓN

170



MARSELLA

170



LYON

172



OREGON

173

# led profile by Luz Negra

Our PROFESSIONAL led profile for surfaces (only 4.05mm high) is manufactured in high purity anodised aluminium and available in two different colours (the profile can also be supplied in raw aluminium with no coating of paint).

The profile is ideal for using on wall surfaces, furniture, shelves and similar areas, where we require a minimalist profile with very reduced dimensions.

Its cover (available in 5 different finishes), has our "easy-ON" system. Once combined with this profile, it provides an IP65 rating to the luminaire.

This can be used in places with high levels of humidity, for example bathrooms, kitchens, gyms, spas, cold storage chambers, fridges, and others.

The profile and its covers are available in lengths of 2 and 6 metres, thus allowing us to carry out large projects where all profiles do not have joints or similar surface breaks.

It is suitable for led strips with a maximum length of 10mm, whose power level does not exceed 15W/m. In order to obtain a more homogeneous and diffused illumination, we recommend using with our opal cover with COB ecoled strips.

**We offer a 10 year guarantee on the profiles and a 4 year guarantee on the covers.**

## MILANO SLIM



IP65



Scale 1:1



Scale 1:2

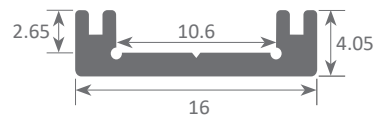

### Aluminium profile

01.016	anodised silver	2m
01.017	anodised black	2m
01.018	anodised silver	6m
01.019	anodised black	6m



### Plastic endcaps

19.206	grey without hole
19.207	grey with hole
19.208	black without hole
19.209	black with hole

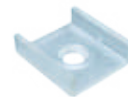

### Clip

20.066 plastic

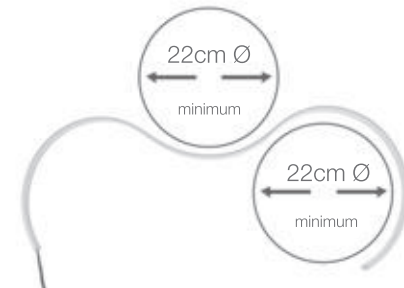

### Polycarbonate cover "easy-ON"

18.001	transparent	2m
18.002	opal	2m
18.003	frosted	2m
18.004	transparent	6m
18.005	opal	6m
18.006	frosted	6m
18.134	frosted	60m

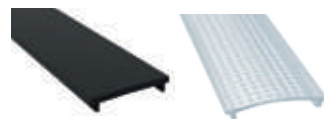

### Black&White cover "easy-ON"

18.007	Black&White	2m
18.008	opaque grey	2m
18.009	Black&White	6m

### Polycarbonate cover "easy-ON"

18.135	microprism	2m
18.136	microprism	6m



### Profile bending machine

22.031 22cm Ø minimum profile curvature



### Hanging KIT

21.001	chrome	set of 2 units
21.002	white	set of 2 units
21.003	black	set of 2 units (clip not included)



Aluminium alloy extrusion process in accordance with: ISO 9001:2008 - ISO 14001 / Tolerances defined by: UNE-EN 755-9 / UNE-EN 12020-2  
Theoretical weight: 0.089kg / Alloy: 6063 / Perimeter: 52mm / Anodising minimum: 15 microns  
Aluminium purity: 95-98% / Material treatment: T-5 / Covers: methacrylate (greater protection against UV rays)



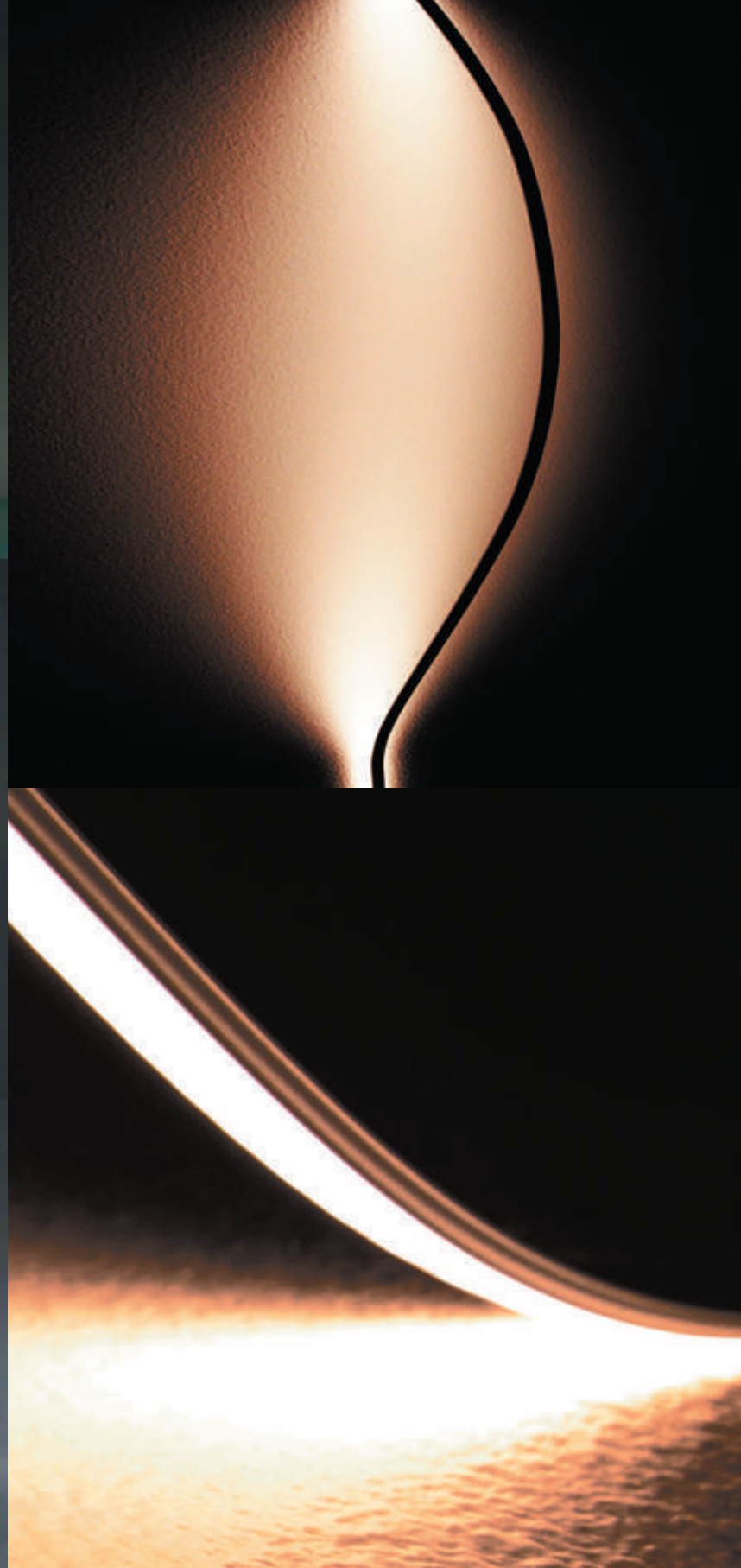

# led profile by Luz Negra

## HARMONY

Our PROFESSIONAL led profile series for surface applications, is manufactured in high purity aluminium and available in silver anodised and lacquered white (on demand, we can offer different anodised and lacquered finishings). This profile can be used for many different purposes, not only surfaces, but also for hanging luminaires or similar, where we require a more flexible profile which can be adapted to certain bends and irregular shapes. Minimum bending radius is of 22cm. Suitable for led strips with a maximum width of 13mm and a power not greater than 20W/m. In order to obtain a more homogeneous illumination, we recommend combining it with our Cies-Barcelona ecoled strips.

**We offer a 2 year guarantee on profiles and covers.**



Scale 1:1



Scale 1:2

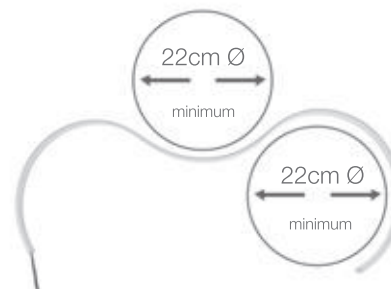
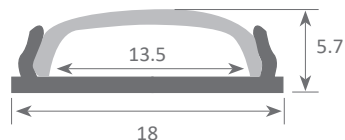

### Aluminium profile

11.001	silver anodised	3m
11.002	white lacquered	3m



### Plastic endcaps

19.154	white with hole
19.155	white without hole



### Polycarbonate cover

18.065	opal	3m
18.066	transparent	3m



### Clip

20.027	chrome steel
--------	--------------



### Profile bending machine

22.031	22cm Ø minimum profile curvature
--------	----------------------------------



Aluminium alloy extrusion process in accordance with: ISO 9001:2008 - ISO 14001 / Tolerances defined by: UNE-EN 755-9 / UNE-EN 12020-2  
Theoretical weight: 0.052kg / Alloy: 6063 / Perimeter: 49.5mm / Anodising minimum: 15 microns  
Aluminium purity: 95-98% / Material treatment: T-5 / Covers: methacrylate (greater protection against UV rays)



Made with Harmony led Profile  
Cortesy of Decovision

# led profile by Luz Negra

## HARMONY XS

Our PROFESSIONAL led profile series for surface applications is manufactured in high purity aluminium and available in silver anodised and lacquered white (on demand, we can offer different anodised and lacquered finishings). This profile can be used for many different purposes, not only surfaces, and also for hanging luminaires or similar where we require a more flexible profile which can adapt to certain bends and irregular shapes. Minimum bending radius must be of 22cm.

Suitable for led strips with a maximum width of 6mm and a power not greater than 20W/m. In order to obtain a more homogeneous illumination, we recommend combining it with our Cies ecoled strips.

**We offer a 2 year guarantee on profiles and covers.**

Scale 1:1



Scale 1:2

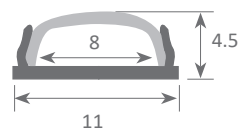

### Aluminium profile

11.003	white lacquered	3m
11.004	silver anodised	3m



### Plastic endcaps

19.156	white without hole
19.157	white with hole



### Profile bending machine

22.031	22cm Ø minimum profile curvature
--------	----------------------------------



### Polycarbonate cover

18.067	opal	3m
18.068	transparent	3m



### Clip

20.028	chrome steel
--------	--------------



Aluminium alloy extrusion process in accordance with: ISO 9001:2008 - ISO 14001 / Tolerances defined by: UNE-EN 755-9  
 UNE-EN 12020-2 / Theoretical weight: 0.033kg / Alloy: 6063 / Perimeter: 34.3mm / Anodising minimum: 15 microns  
 Aluminium purity: 95-98% / Material treatment: T-5 / Covers: methacrylate (greater protection against UV rays)

# Flex&Cover

These are opaline, flexible PVC covers which are ideal for outdoor use and treadable.

Specially indicated for applications where we need a curve (both concave and convex), such as in furniture, displays and similar. By applying pressure they are inserted into wooden surfaces, PVC, plaster, etc.

The led which is to be used, must have a power not greater than 14W/m unless it is used with compatible led profiles, indicated on page 40.

On demand we can supply any of these profiles in opaline colours (please check with our technical department).



## Rubber profile PVC

11.005 white 20m roll

## MONTRY Cover

Minimum profile curvature: 50mm  
Compatible with magnetic base 22.032



## MONTRY Magnetic base

Scale 1:1

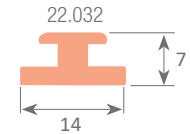

Scale 1:1

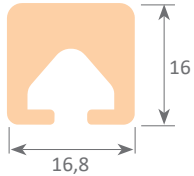

## Rubber profile PVC

11.006 white 50m roll  
11.007 white 10m roll

## CANNES

Minimum profile curvature: 50mm

## Rubber profile PVC

11.012 white 40m roll  
11.013 white 10m roll

## ESBLY

Minimum profile curvature: 50mm

Scale 1:1

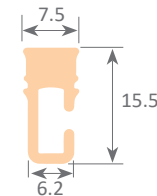

Scale 1:1

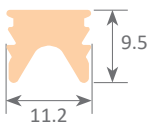

## Rubber profile PVC

11.008 white 50m roll  
11.009 white 10m roll

## LILLE

Minimum profile curvature: 50mm

## Rubber profile PVC

11.014 white 25m roll  
11.015 white 10m roll

## AVIÑON

Minimum profile curvature: 80mm

Scale 1:1

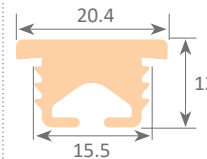

Scale 1:1

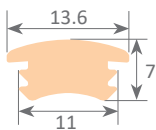

## Rubber profile PVC

11.010 white 40m roll  
11.011 white 10m roll

## ARLES

Minimum profile curvature: 80mm

Scale 1:1

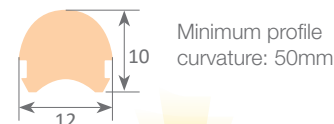

Minimum profile curvature: 50mm

## MARSELLA

### Rubber profile PVC

11.020 yellow 10m roll  
11.021 green 10m roll  
11.022 blue 10m roll  
11.023 white 10m roll  
11.024 orange 10m roll  
11.025 red 10m roll  
11.026 pink 10m roll  
11.027 purple 10m roll

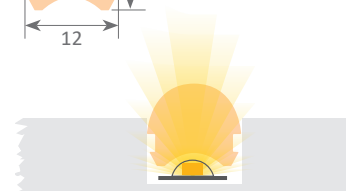

Scale 1:1

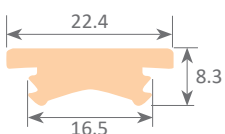

Aluminium alloy extrusion, testing method: Volumetric mass ISO 1183/87 / Shore hardness A: ISO 868/85  
Breaking load: ISO R 527/66 / Elongation: ISO R 527/66 / Fire resistance: UL94



# Flex&Cover

by Luz Negra

# led profile by Luz Negra

## LYON

Our BASIC led profile series for surface applications is manufactured in a grey coloured flexible silicone (on demand, we can supply different finishings).

This profile is specially suitable for embedding into straight or curved wooden surfaces (minimum bending radius being 20cm).

Suitable for led strips with a maximum width of 10mm and a power not greater than 10W/m.

This profile does not have any cover, so we recommend using it with our Ibiza PRO ecoled strip, which offers an IP67 DUO protection layer (preventing dust and dirt from entering).

**We offer a 2 year guarantee.**



Scale 1:1



Scale 1:2

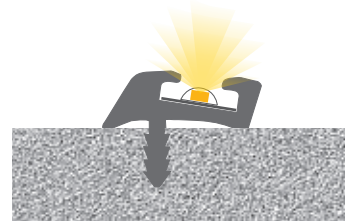
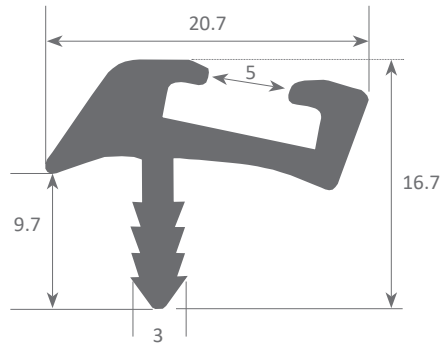

**Silicone profile**

11.019 grey

1m









## silicone led profiles (neon)



We have incorporated into our range of products 10 high quality silicone profiles with all their accessories. We can insert the required led strip inside, in order to create texts or perimetral decorative lighting. These profiles are suitable for indoor or outdoor zones (IP67).



NEON MICRO

176



NEON MINI

177



NEON CUADRADO

178



NEON REDONDO

180



NEON REDONDO XL

181



NEON DOBLE

182



NEON XL

183



NEON LAS VEGAS

184



NEON LAS VEGAS XL

185



FONTANA

186



NEON EASY

186A

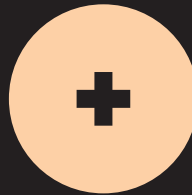

NEON 360°

186B



NEON SLIM

186D



NEON CUADRADO XL

186E



NEON LAS VEGAS EASY

186F

# led profile by Luz Negra

A very small, high quality silicone profile with an opal front. It is suitable for perimetral decorative lighting, illuminating cavities, etc. As it is extremely thin, it is also ideal for publicity texts and corporate letters on a small scale (its flexibility allows us to create very small letters).

It has an internal cavity that can house an IP20 led strip, with a PCB of 4mm or 5mm and the recommended power not greater than 12W/m. We recommend combining this profile with ecoled Cies. Thanks to its IP67 waterproofing and its UV protection, this product is suitable for outdoor areas and damp zones (sealing the connector and the endcap with the recommended silicone is a must). We offer you this profile in 100m rolls or cut to size (minimum 1m MOQ).

**We offer a 2 year guarantee.**

## NEON MICRO



Scale 1:2

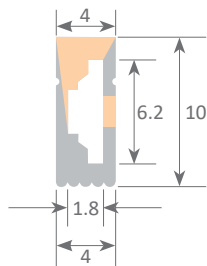

Scale 1:1



### Neon Micro Led

10.001 Neón micro 1-100m  
(PCB max. 6mm)



### Silicone endcaps

19.160 without hole  
19.161 with hole



### Silicone for waterproofing

22.033 100ml

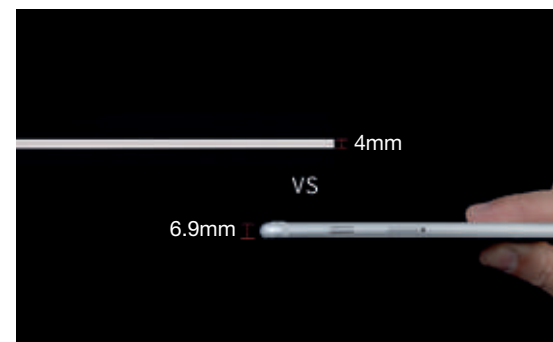

### Clip

20.031 white plastic  
20.032 aluminium



### Silicone for waterproofing

22.138 opal 45ml  
22.140 transparent 45ml

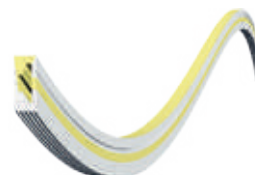

How to bend



# led profile by Luz Negra

A very small, high quality silicone profile with an opal front. It is suitable for perimetral decorative lighting, illuminating cavities, etc. As it is extremely thin, it is also ideal for publicity texts and corporate letters on a small scale (its flexibility allows us to create very small letters).

It has an internal cavity that can house an IP20 led strip, with a PCB of 4mm or 5mm and the recommended power not greater than 12W/m. We recommend combining this profile with ecoled Cíes. Thanks to its IP67 waterproofing and its UV protection, this product is suitable for outdoor areas and damp zones (sealing the connector and the endcap with the recommended silicone is a must). We offer you this profile in 100m rolls or cut to size (minimum 1m MOQ).

**We offer a 2 year guarantee.**

## NEON MINI

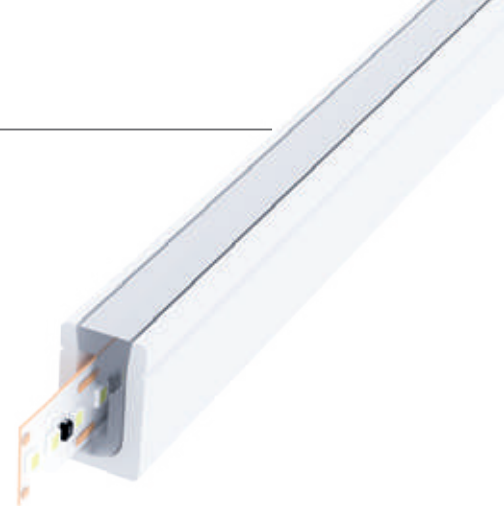

Scale 1:2

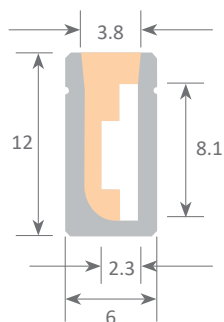

Scale 1:1



### Neon Mini Led

10.002 Neón mini 1-100m  
(PCB max. 8mm)

### Silicone endcaps

19.162 without hole  
19.163 with hole



### Die-cut profile

10.218 aluminium m



### Silicone for waterproofing

22.138 opal 45ml  
22.140 transparent 45ml



### Clip

20.033 aluminium



How to bend



A high quality silicone profile with an opal front. It is suitable for perimetral decorative lighting, illuminating cavities, etc. It is ideal for publicity texts and corporate letters, similar to traditional neons. It has an internal cavity that can house an IP20 led strip, with a PCB of 4mm or 5mm and the recommended power not greater than 12W/m. We recommend combining this profile with ecoled Cob 5mm. Thanks to its IP67 waterproofing and its UV protection, this product is suitable for outdoor areas and damp zones (sealing the connector and the endcap with the recommended silicone is a must). We offer you this profile in 100m rolls or cut to size (minimum 1m MOQ).

**We offer a 2 year guarantee.**

## NEON CUADRADO



Scale 1:2

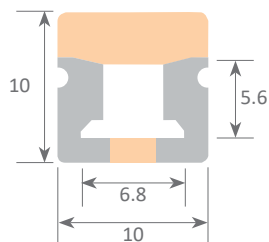

Scale 1:1



### Neon Cuadrado Led

10.003 Neón cuadrado 1-100m  
(PCB max. 6mm)



### Silicone endcaps

19.164 without hole  
19.165 with front hole  
19.166 with side hole



### Clip

20.034 aluminium



### Silicone for waterproofing

22.138 opal 45ml  
22.140 transparent 45ml

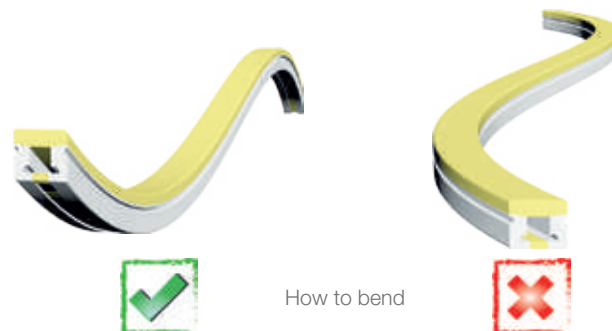
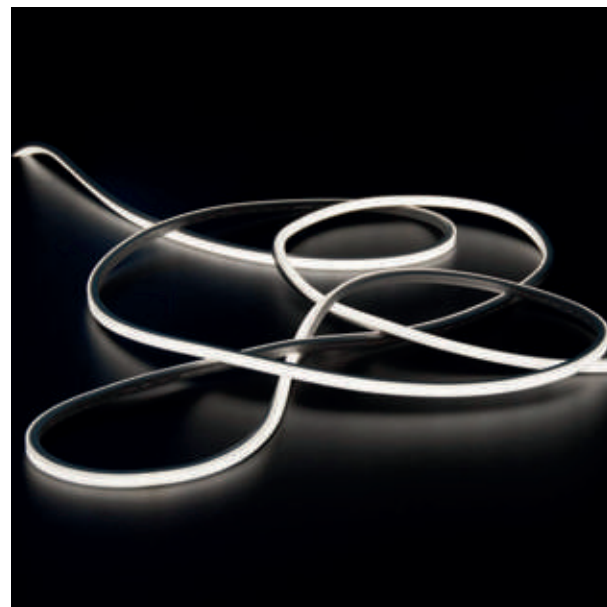

Get  
them out  
cupsakes

# led profile by Luz Negra

A high quality opal coloured silicone profile. It is suitable for perimetral decorative lighting, illuminating cavities, etc. It is ideal for publicity texts and corporate letters, similar to traditional neons.

It has an internal cavity that can house an IP20 led strip, with a PCB of 4mm or 5mm and the recommended power not greater than 12W/m. We recommend combining this profile with ecoled Cies.

Thanks to its IP67 waterproofing and its UV protection, this product is suitable for outdoor areas and damp zones (sealing the connector and the endcap with the recommended silicone is a must). We offer you this profile in 100m rolls or cut to size (minimum 1m MOQ).

**We offer a 2 year guarantee.**

## NEON REDONDO



Scale 1:2

Scale 1:1

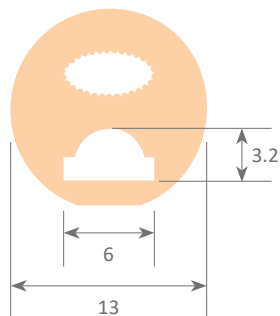

### Neon Redondo Led

10.004 Neón redondo 1-100m  
(PCB max. 5mm)

### Silicone endcaps

19.167 without hole  
19.168 with hole



### Clip

20.035 plastic



### Silicone for waterproofing

22.138 opal 45ml  
22.140 transparent 45ml



How to bend





# led profile by Luz Negra

A high quality opal coloured silicone profile. It is suitable for perimetral decorative lighting, illuminating cavities, etc. It is ideal for publicity texts and corporate letters, similar to traditional neons.

It has an internal cavity that can house an IP20 led strip, with a PCB of 10mm and the recommended power not greater than 12W/m. We recommend combining this profile with ecoled Castellón-Elite 10. Thanks to its IP67 waterproofing and its UV protection, this product is suitable for outdoor areas and damp zones (sealing the connector and the endcap with the recommended silicone is a must). We offer you this profile in 50m rolls or cut to size (minimum 1m MOQ).

**We offer a 2 year guarantee.**

## NEON REDONDO XL

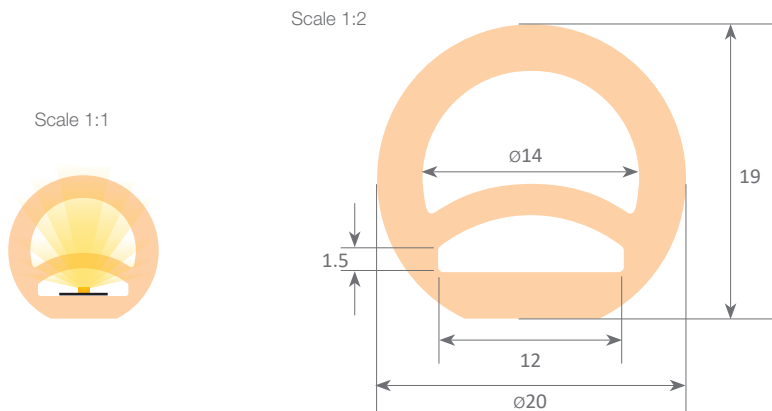
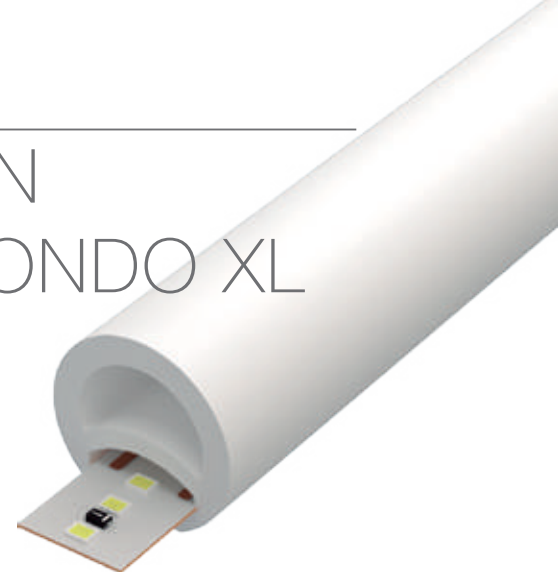

### Neon Redondo XL Led

10.010 Neón redondo XL 1-50m  
(PCB max. 10mm)



### Silicone endcaps

19.226 with hole  
19.227 without hole



### Silicone for waterproofing

22.138 opal 45ml  
22.140 transparent 45ml



### Clip

20.065 plastic

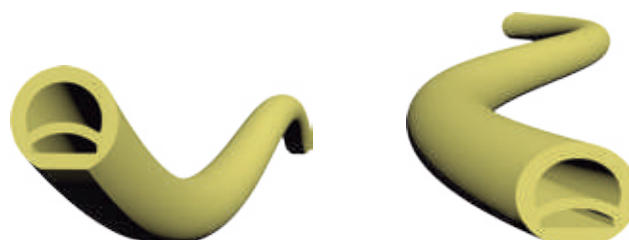

How to bend



# led profile by Luz Negra

A high quality silicone profile with front and side finishings in opal. It is suitable for perimetral decorative lighting, illuminating cavities, floor embedding etc.

It has two internal cavities which house an IP20 led strip, with a PCB of 10mm and a power not greater than 14W/m. We recommend combining this profile with ecoled Castellón.

Thanks to its IP67 waterproofing and its UV protection, this product is suitable for outdoor areas and damp zones (sealing the connector and the endcap with the recommended silicone is a must). We offer you this profile in 25m rolls or cut to size (minimum 1m MOQ).

**We offer a 2 year guarantee.**

## NEON DOBLE

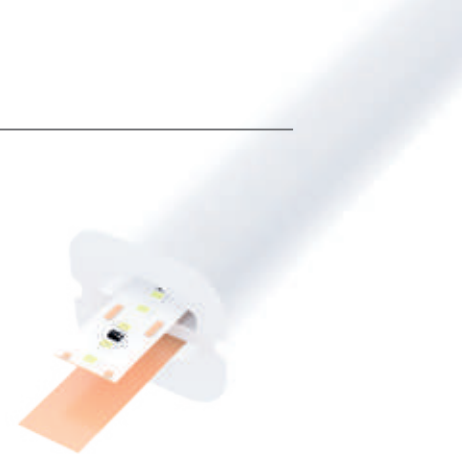

Scale 1:1

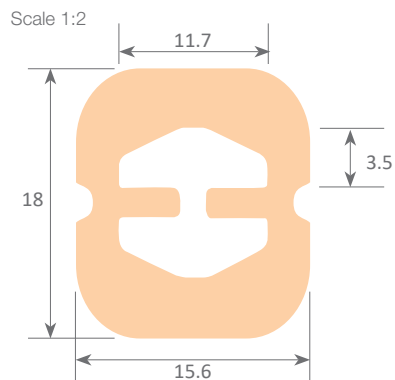

### Neon Doble Led

10.008 Neón doble 1-25m  
(PCB max. 10mm)



### Silicone endcaps

19.179 without hole  
19.180 with hole



### Clips

20.039 plastic  
20.040 aluminium  
20.065 plastic



### Silicone for waterproofing

22.138 opal 45ml  
22.140 transparent 45ml

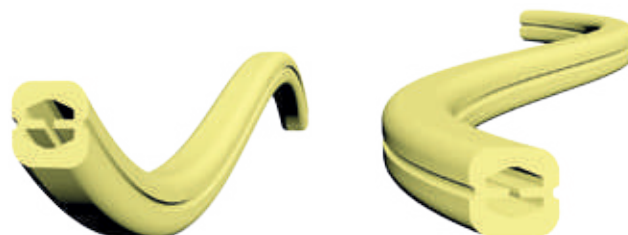

How to bend



## NEON XL

A high quality silicone profile with an opal front. It is suitable for perimetral decorative lighting, illuminating cavities, etc. It is ideal for publicity texts specially when large corporate letters are requested. It has one internal cavity that can house an IP20 led strip, with a PCB of 10mm and a power not greater than 14W/m. We recommend combining this profile with ecoled Castellón.

Thanks to its IP67 waterproofing and its UV protection, this product is suitable for outdoor areas and damp zones (sealing the connector and the endcap with the recommended silicone is a must). We offer you this profile in 100m rolls or cut to size (minimum 1m MOQ).

**We offer a 2 year guarantee.**

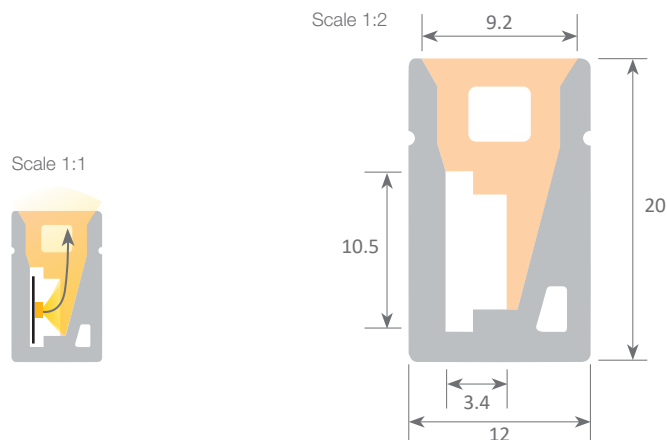

**Neon XL Led**  
10.005 Neón XL 1-100m  
(PCB max. 10mm)



**Die-cut profile**  
10.219 aluminium m



**Silicone for waterproofing**  
22.138 opal 45ml  
22.140 transparent 45ml



**Silicone endcaps**  
19.173 without hole  
19.174 with front hole  
19.175 with side hole  
19.176 with bottom hole

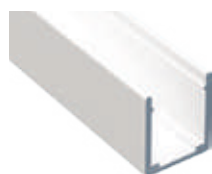

**Clip profile**  
20.080 white aluminium 2m



**Clip**  
20.036 aluminium  
20.079 white aluminium



How to bend



A high quality silicone profile with front and side finishings in opal. It is suitable for perimetral decorative lighting, illuminating cavities, etc. It is ideal for publicity texts specially when large corporate letters are requested.

It has one internal cavity that can house an IP20 led strip, with a PCB of 10mm and a power not greater than 14W/m. We recommend combining this profile with ecoled Castellón.

Thanks to its IP67 waterproofing and its UV protection, this product is suitable for outdoor areas and damp zones (sealing the connector and the endcap with the recommended silicone is a must). We offer you this profile in 100m rolls or cut to size (minimum 1m MOQ).

**We offer a 2 year guarantee.**

## NEON LAS VEGAS



Scale 1:1

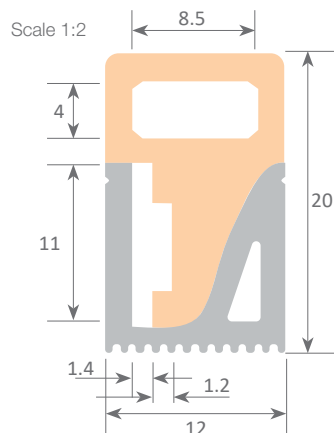
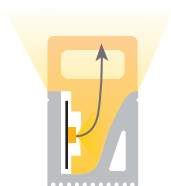

### Neon Las Vegas Led

10.006 Neón Las Vegas 1-100m  
(PCB max. 10mm)



### Die-cut profile

10.219 aluminium m



### Silicone for waterproofing

22.138 opal 45ml  
22.140 transparent 45ml

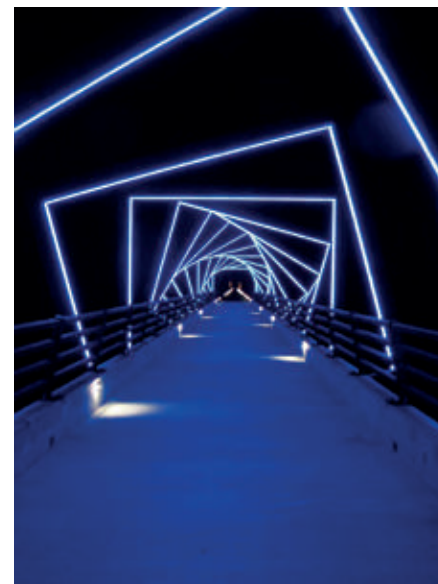

### Silicone endcaps

19.173 without hole  
19.174 with front hole  
19.175 with side hole  
19.176 with bottom hole

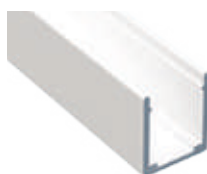

### Clip profile

20.080 white aluminium 2m



### Clip

20.037 aluminium  
20.079 white aluminium

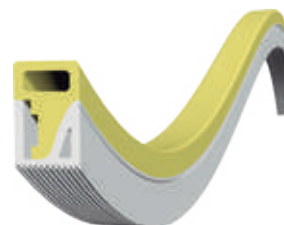

How to bend



A high quality silicone profile with front and side finishings in opal. It is suitable for perimetral decorative lighting, illuminating cavities, etc. It is ideal for publicity texts specially when large corporate letters are requested. It has one internal cavity that can house an IP20 led strip, with a PCB of 10mm and a power not greater than 14W/m. We recommend combining this profile with ecoled Castellón. It also has 2 additional cavities which allow us to insert aluminium plates which give body to the shapes created, keeping them in place.

Thanks to its IP67 waterproofing and its UV protection, this product is suitable for outdoor areas and damp zones (sealing the connector and the endcap with the recommended silicone is a must). We offer you this profile in 40m rolls or cut to size (minimum 1m MOQ).

**We offer a 2 year guarantee.**

## NEON LAS VEGAS XL

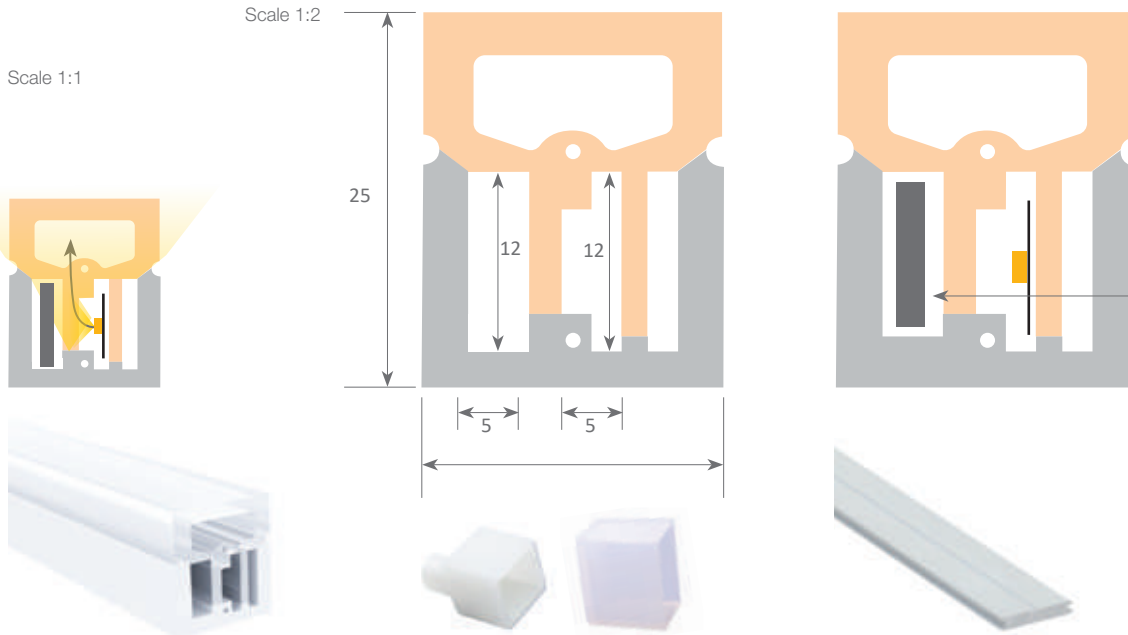

Las Vegas XL is a silicone profile which houses inside, apart from the led strip, 1 aluminium plate (which gives body to the shapes created, keeping them in place ).  
Ref: 01.014

**Neon Las Vegas XL Led**  
10.007 Neón Las Vegas XL 1-40m  
(PCB max. 10mm)

**Silicone endcaps**  
19.177 without hole  
19.178 with hole

**Aluminium profile**  
01.014 anodised silver 2m

**Clip**  
20.038 plastic  
20.074 aluminium

**Silicone for waterproofing**  
22.138 opal 45ml  
22.140 transparent 45ml

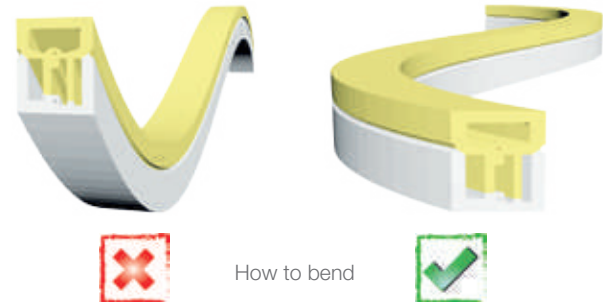

How to bend



# led profile by Luz Negra

## FONTANA

Our PROFESIONAL led profile series for surfaces is made of transparent silicone. This profile is designed for waterproofing flexible led strips. Suitable for use with led strips with a PCB width of 10mm and the recommended power not greater than 20W/m.

We recommend using a thread in order to install the led strip inside this profile. For the complete module, we can achieve a watertightness of IP67 by sealing the endcaps to the profile.

**We offer a 2 year guarantee.**



Scale 1:1



Scale 1:2

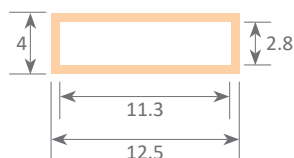

### Silicone profile

10.009 transparent 1-200m

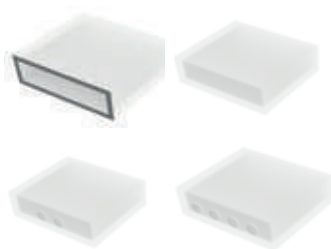

### Silicone endcaps

19.181 without hole  
19.182 with 2 holes  
19.183 with 4 holes

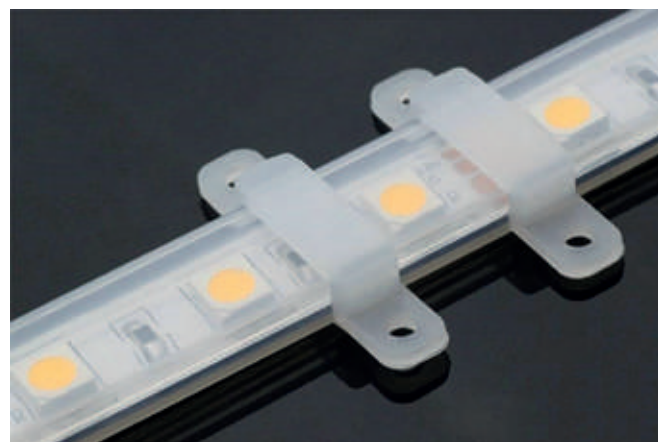

### Clip

20.041 silicone  
20.077 silicone



### Silicone for waterproofing

22.138 opal 45ml  
22.140 transparent 45ml



How to bend



# Big Profiles



A wide range of large and medium sized profiles used to manufacture surface, hanging, recessed luminaires or wall lamps.

Our main models are available with our exclusive IP65 “easy-ON” system. Both profile and cover are also available in lengths of up to 6 metres in one single piece.

We also offer models with trellis covers, optics, 3-phase rails for spotlights, recessed and assymetrical lighting.

# led profile by Luz Negra

System with front removable tray which permits easy access to the led strip and power supply, therefore allowing very fast and simple maintenance.

Up&Down cover available in transparent or frosted white.

Safety cable which fixes the removable tray to the profile and also making maintenance easier.

Vossloh-Schwabe power supply with Dali, 1-10V or PUSH controllers, offering a 5 year guarantee.

Aluminium front removable tray with triple safety system (clipping of cover, safety cable and screw).

“easy-ON” IP65 cover (European patent), available in opal white, transparent microprism and Black&White.

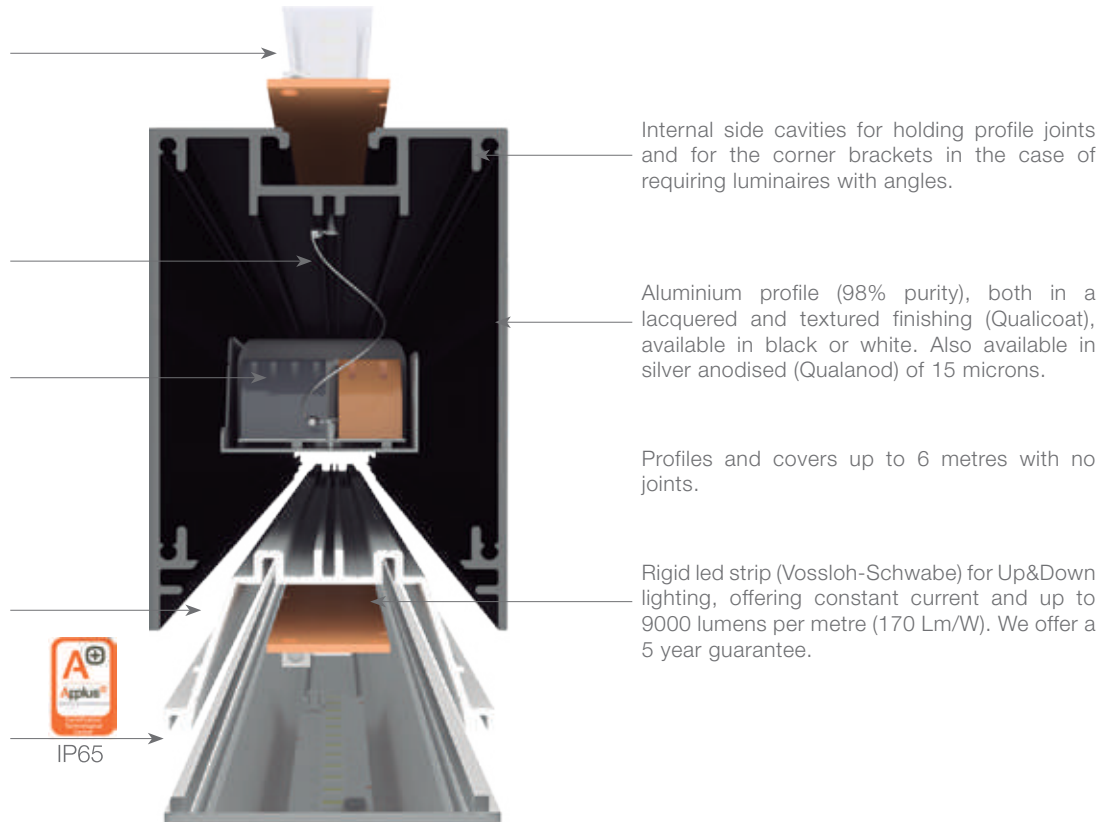

## Front removable tray system with triple fall protection (safety anchorage)

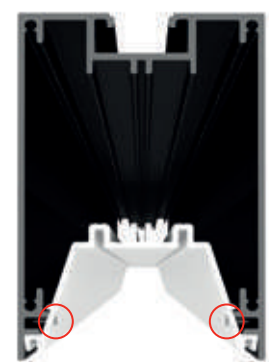
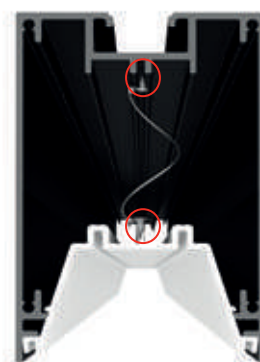
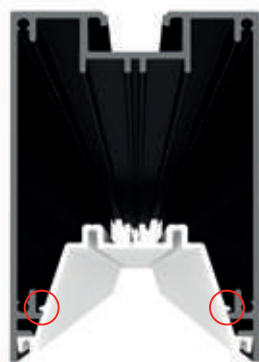



Aluminium profiles with our “easy-ON” system, offering an IP65 and designed for hanging, surfaces and embedding.

Front removable tray with triple safety system (except “Mini” models).

MOSCU  
MAGNUM



MUNICH  
MAGNUM



MOSCU  
MAGNUM  
SLIM



MUNICH  
MAGNUM  
SLIM



MOSCU  
MINI



MUNICH  
MINI



MOSCU  
MINI

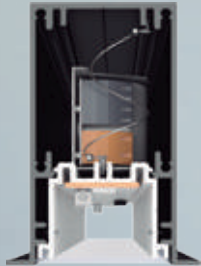

MOSCU  
MAGNUM  
SLIM

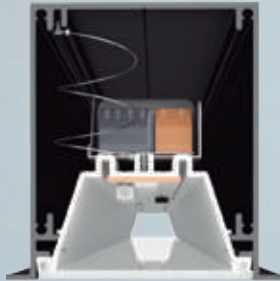

MOSCU  
MAGNUM



MUNICH  
MINI



MUNICH  
MAGNUM  
SLIM



MUNICH  
MAGNUM

# led profile by Luz Negra

## NEON EASY

High quality silicone neon profile with opal front and rear opening which enables easy placing of the waterproof led strip.

Ideal for lighting up cavities, cornices and for decorative perimetral lighting in general.

If combined with our Infinity led strip (direct at 230V), you will be able to create a neon flex of up to 50m in length and easily powered from one end – no need for any power supply and no visible voltage drop. (minimum purchase 1m).

**We offer a 2 year guarantee.**



Scale 1:1



Scale 1:2

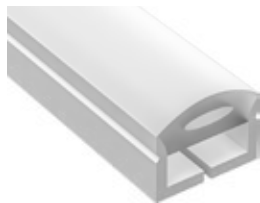
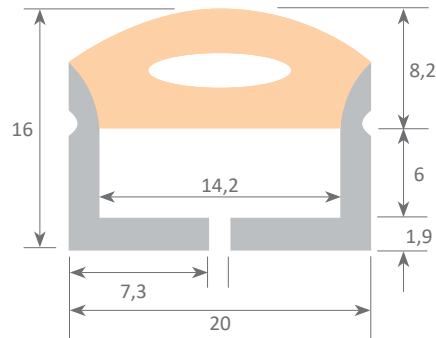

### Neon easy Led

10.215 Neón easy 50m  
(PCB max. 14mm)



### Silicone endcaps

19.370 with hole  
19.371 without hole

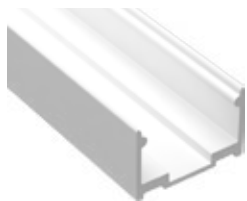

### clip profile

22.188 white aluminium 2m



### Clip

20.072 white aluminium

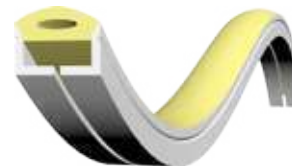
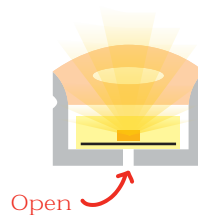

How to bend

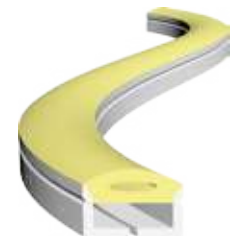

# led profile by Luz Negra

High quality silicone profile which is visually attractive and offers 100% dot-free effect. Manufactured via a silicone extrusion process, meaning it can be easily curved in arbitrary shapes. It is ideal for carrying out customised projects as it can be cut every centimetre.

It has an internal cavity for housing 2 led strips in order to achieve 360° lighting without any dark areas. It is available in 4000K and 2700K with a power of 14.4W/m.

Thanks to its IP65 waterproofing and its UV protection, this product is suitable for outdoor areas and damp zones (sealing the connector and the endcap with the recommended silicone is a must). This profile is available in 5m rolls. On request it can be manufactured in RGB, CCT and digital.

**We offer a 2 year guarantee.**

## NEON 360°

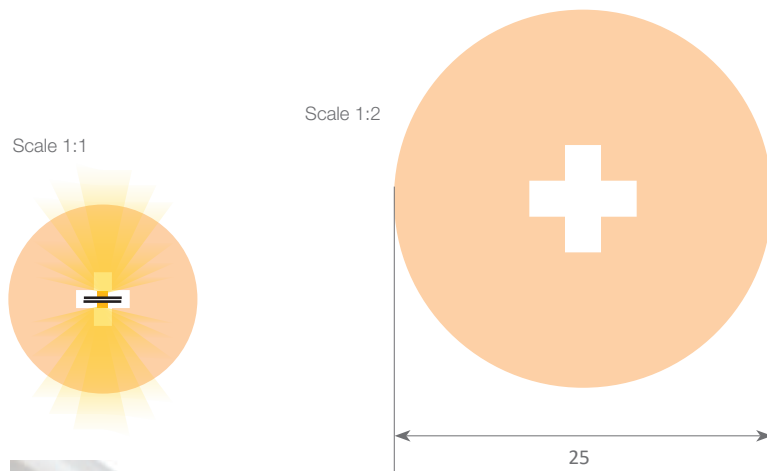

### Neon 360°

10.225 white 4000°K 14.4W/m 770 Lm  
10.226 white 2700°K 14.4W/m 810 Lm



### Plastic endcaps

10.235 with hole and without hole set of 2pcs

Power (W)	14.4W/m
Voltage (V)	24V
Light emission	360°
Waterproofing	IP65
N° leds/m	200
Cutttable	every 10mm
Minimum radius of curvature	R≥120mm
Working temperature	-20°C / +40°C
Apt for	for outdoor / interior use
Guarantee	2 years



### Polycarbonate clip

10.233 transparent



### Polycarbonate tube

10.239 transparent

2.5m



### Plastic profile clip

10.231 transparent 1m



### Plastic clip

10.238 transparent

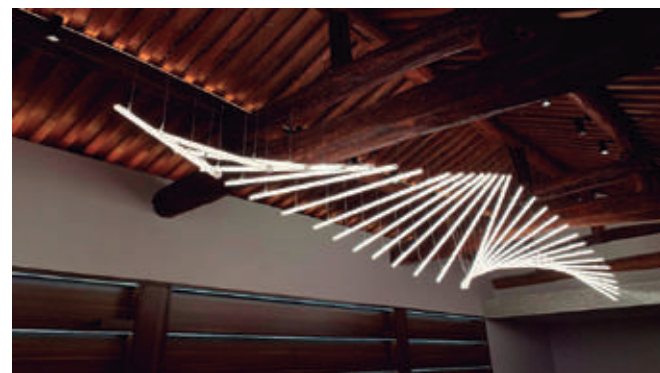

10.227

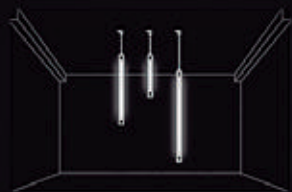

10.230

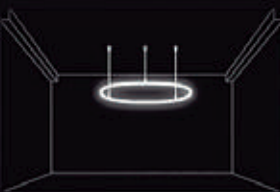

10.229

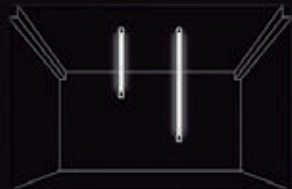

10.229

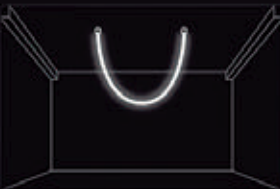

10.230 + 10.239

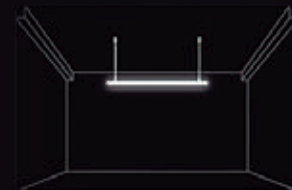

10.234

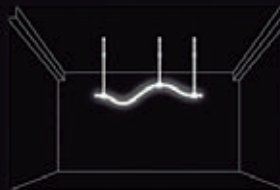

10.239



10.238



**Hanger for vertical use  
(direct to ceiling)**

10.229 anodised silver



**Hanger for vertical use  
(with cable)**

10.227 anodised silver



**Hanger for horizontal use  
(with cable)**

10.228 anodised silver



**Hanger for horizontal use  
(full kit)**

10.230 anodised silver



**Telescopic suspension arm**

10.234 transparent plastic



**Joint**

10.232 anodised silver

## NEON SLIM

A very small, high quality silicone profile with a transparent front, etched with fine lines which favours a low UGR.

It is suitable for perimetral decorative lighting for cavities etc and as it is extremely thin, it is also ideal for publicity texts and corporate letters on a small scale (its flexibility allows us to create very small letters). It has an internal cavity that can house an IP20 led strip, with a PCB of 10mm and the recommended power not greater than 12W/m. We recommend combining this profile with ecoled COB (dot-free effect).

Thanks to its IP67 waterproofing and its UV protection, this product is suitable for outdoor areas and damp zones (sealing the connector and the endcap with the recommended silicone is a must).

We offer you this profile in 100m rolls or cut to size (minimum 1m MOQ).

**We offer a 2 year guarantee.**



Scale 1:1



Scale 1:2

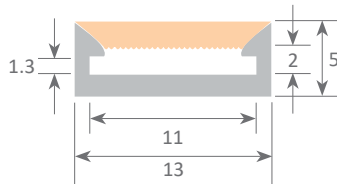

### Neon Slim Led

10.215 Neon slim 50m  
(Max. PCB 10mm)



### Silicone endcaps

19.163 with front hole  
19.184 with front hole  
19.185 without hole  
  
19.181 without hole  
19.182 with 2 holes  
19.183 with 4 holes



### Silicone for waterproofing

22.138 opal 45ml  
22.140 transparent 45ml



### Clip

20.041 silicone  
20.075 plastic



How to bend



# led profile by Luz Negra

A high quality silicone profile with an opal front. It is suitable for perimetral decorative lighting, illuminating cavities, etc. It is ideal for publicity texts and corporate letters, similar to traditional neons. It has an internal cavity that can house an IP20 led strip, with a PCB of 8mm and the recommended power not greater than 12W/m. We recommend combining this profile with ecoled COB.

Thanks to its IP67 waterproofing and its UV protection, this product is suitable for outdoor areas and damp zones (sealing the connector and the endcap with the recommended silicone is a must). We offer you this profile in 100m rolls or cut to size (minimum 1m MOQ).

**We offer a 2 year guarantee.**

## NEON CUADRADO XL



Scale 1:1



Scale 1:2

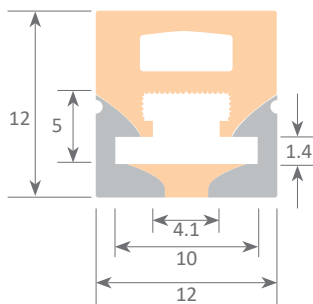

### Neon Cuadrado XL Led

10.216 Neon cuadrado XL 1-100m  
(Max. PCB 10mm)



### Silicone endcaps

19.385 with front hole  
19.386 with front hole  
19.387 without hole



### Clip

20.076 aluminium



### Silicone for waterproofing

22.138 opal 45ml  
22.140 transparent 45ml



How to bend



# led profile by Luz Negra

High quality silicone neon profile with opal front and rear opening which enables easy placing of the waterproof led strip.

Ideal for lighting up cavities, cornices and for decorative perimetral lighting in general.

If combined with our Infinity led strip (direct at 230V), you will be able to create a neon flex of up to 50m in length and easily powered from one end – no need for any power supply and no visible voltage drop. (minimum purchase 1m).

**We offer a 2 year guarantee.**

## NEON LAS VEGAS EASY



Scale 1:1

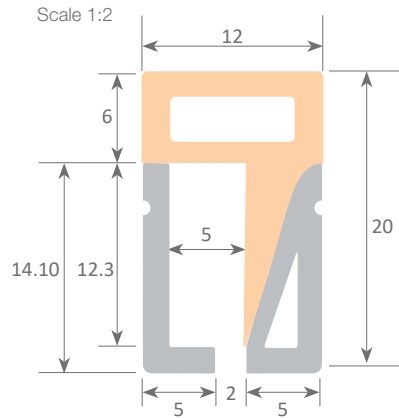
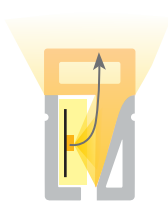

### Led Neon Las Vegas Easy

10.032 Neon las vegas easy 100m  
(Max. PCB 12mm)



### Die-cut profile

10.219 aluminium m

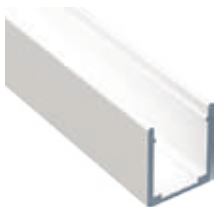

### Clip profile

20.080 white aluminium 2m



### Silicone endcaps

19.173 without hole  
19.174 with front hole  
19.175 with side hole  
19.176 with bottom hole



### Clip

20.079 white aluminium



Open



How to bend

# led profile by Luz Negra

A high quality silicone profile with front and side finishings in opal. It is suitable for perimetral decorative lighting, illuminating cavities, floor embedding etc.

It has two internal cavities which house an IP20 led strip, with a PCB of 10mm and a power not greater than 14W/m. We recommend combining this profile with ecoled Castellón.

Thanks to its IP67 waterproofing and its UV protection, this product is suitable for outdoor areas and damp zones (sealing the connector and the endcap with the recommended silicone is a must). We offer you this profile in 25m rolls or cut to size (minimum 1m MOQ).

**We offer a 2 year guarantee.**

## NEON DOBLE

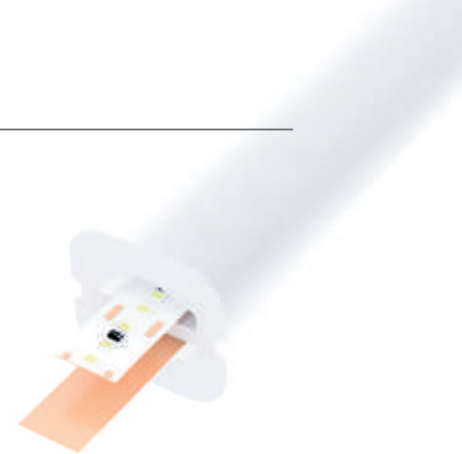

Scale 1:1

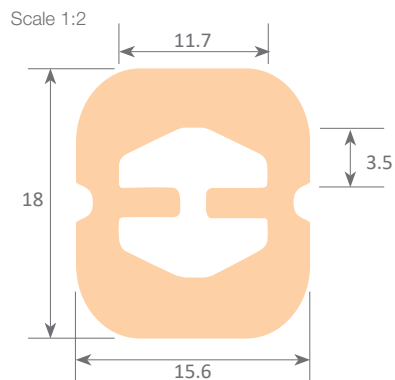

### Neon Doble Led

10.008 Neón doble 1-25m  
(PCB max. 10mm)



### Silicone endcaps

19.179 without hole  
19.180 with hole



### Clips

20.039 plastic  
20.040 aluminium  
20.065 plastic



### Silicone for waterproofing

22.138 opal 45ml  
22.140 transparent 45ml



How to bend





## NEON XL

A high quality silicone profile with an opal front. It is suitable for perimetral decorative lighting, illuminating cavities, etc. It is ideal for publicity texts specially when large corporate letters are requested. It has one internal cavity that can house an IP20 led strip, with a PCB of 10mm and a power not greater than 14W/m. We recommend combining this profile with ecoled Castellón.

Thanks to its IP67 waterproofing and its UV protection, this product is suitable for outdoor areas and damp zones (sealing the connector and the endcap with the recommended silicone is a must). We offer you this profile in 100m rolls or cut to size (minimum 1m MOQ).

**We offer a 2 year guarantee.**



Scale 1:1



Scale 1:2

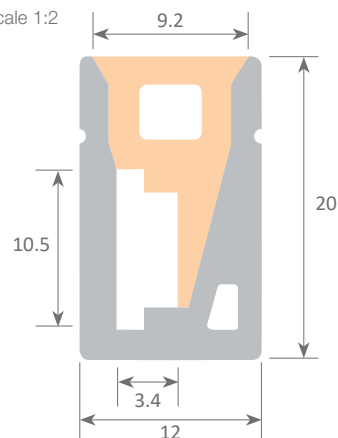

### Neon XL Led

10.005 Neón XL 1-100m  
(PCB max. 10mm)



### Die-cut profile

10.219 aluminium m



### Silicone for waterproofing

22.138 opal 45ml  
22.140 transparent 45ml

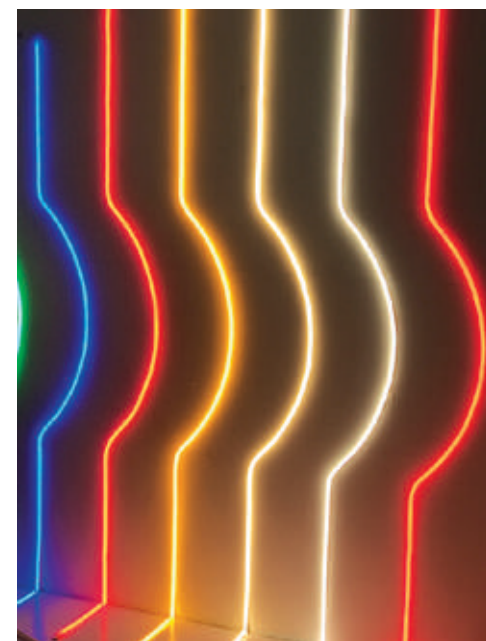

### Silicone endcaps

19.173 without hole  
19.174 with front hole  
19.175 with side hole  
19.176 with bottom hole

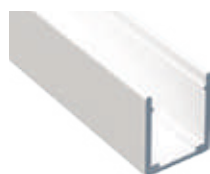

### Clip profile

20.080 white aluminium 2m



### Clip

20.036 aluminium  
20.079 white aluminium



How to bend



## NEON LAS VEGAS

A high quality silicone profile with front and side finishings in opal. It is suitable for perimetral decorative lighting, illuminating cavities, etc. It is ideal for publicity texts specially when large corporate letters are requested.

It has one internal cavity that can house an IP20 led strip, with a PCB of 10mm and a power not greater than 14W/m. We recommend combining this profile with ecoled Castellón.

Thanks to its IP67 waterproofing and its UV protection, this product is suitable for outdoor areas and damp zones (sealing the connector and the endcap with the recommended silicone is a must). We offer you this profile in 100m rolls or cut to size (minimum 1m MOQ).

**We offer a 2 year guarantee.**



Scale 1:1

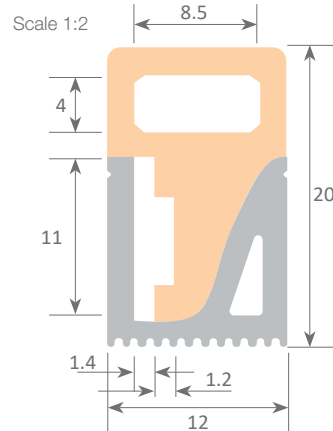
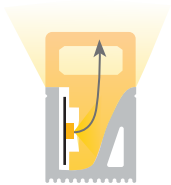

### Neon Las Vegas Led

10.006 Neón Las Vegas 1-100m  
(PCB max. 10mm)



### Die-cut profile

10.219 aluminium m



### Silicone for waterproofing

22.138 opal 45ml  
22.140 transparent 45ml



### Silicone endcaps

19.173 without hole  
19.174 with front hole  
19.175 with side hole  
19.176 with bottom hole

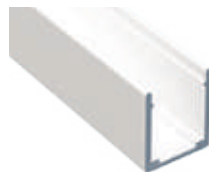

### Clip profile

20.080 white aluminium 2m



### Clip

20.037 aluminium  
20.079 white aluminium

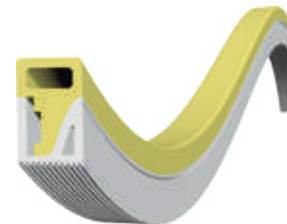

How to bend



A high quality silicone profile with front and side finishings in opal. It is suitable for perimetral decorative lighting, illuminating cavities, etc. It is ideal for publicity texts specially when large corporate letters are requested. It has one internal cavity that can house an IP20 led strip, with a PCB of 10mm and a power not greater than 14W/m. We recommend combining this profile with ecoled Castellón. It also has 2 additional cavities which allow us to insert aluminium plates which give body to the shapes created, keeping them in place.

Thanks to its IP67 waterproofing and its UV protection, this product is suitable for outdoor areas and damp zones (sealing the connector and the endcap with the recommended silicone is a must). We offer you this profile in 40m rolls or cut to size (minimum 1m MOQ).

**We offer a 2 year guarantee.**

## NEON LAS VEGAS XL

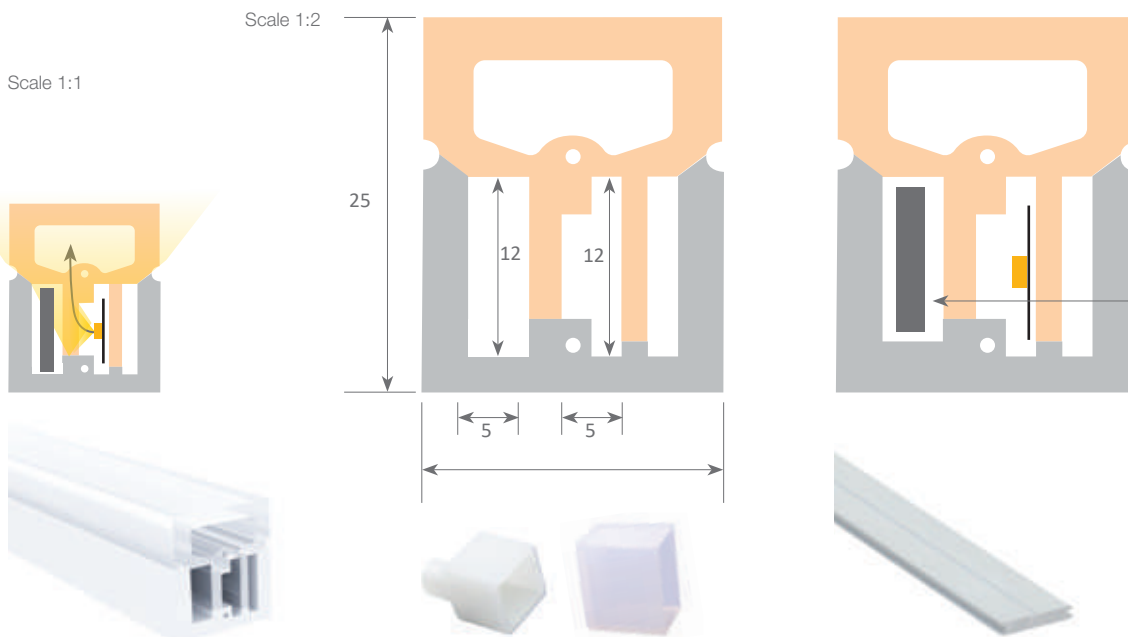

Las Vegas XL is a silicone profile which houses inside, apart from the led strip, 1 aluminium plate (which gives body to the shapes created, keeping them in place ).  
Ref: 01.014

### Neon Las Vegas XL Led

10.007 Neón Las Vegas XL 1-40m  
(PCB max. 10mm)

### Silicone endcaps

19.177 without hole  
19.178 with hole

### Aluminium profile

01.014 anodised silver 2m



### Clip

20.038 plastic  
20.074 aluminium



### Silicone for waterproofing

22.138 opal 45ml  
22.140 transparent 45ml

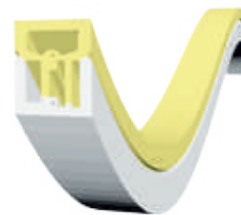

How to bend



# led profile by Luz Negra

## FONTANA

Our PROFESIONAL led profile series for surfaces is made of transparent silicone. This profile is designed for waterproofing flexible led strips. Suitable for use with led strips with a PCB width of 10mm and the recommended power not greater than 20W/m.

We recommend using a thread in order to install the led strip inside this profile. For the complete module, we can achieve a watertightness of IP67 by sealing the endcaps to the profile.

**We offer a 2 year guarantee.**

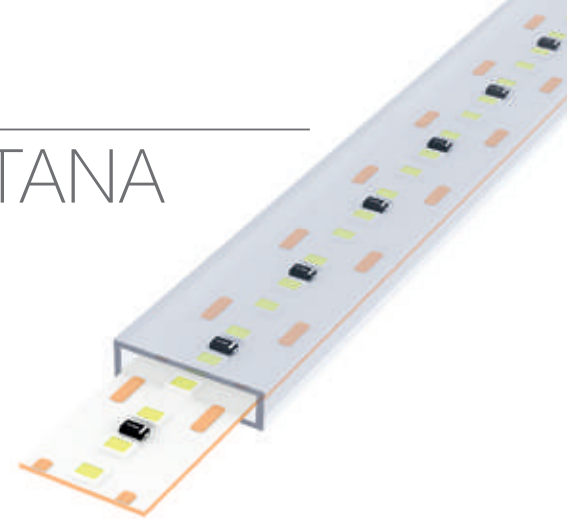

Scale 1:1



Scale 1:2

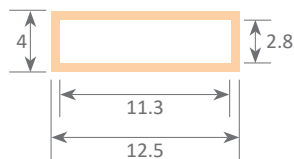

### Silicone profile

10.009 transparent 1-200m

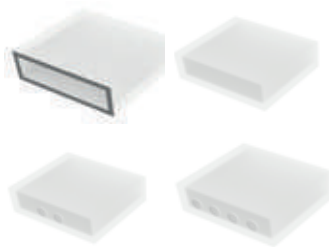

### Silicone endcaps

19.181 without hole  
19.182 with 2 holes  
19.183 with 4 holes

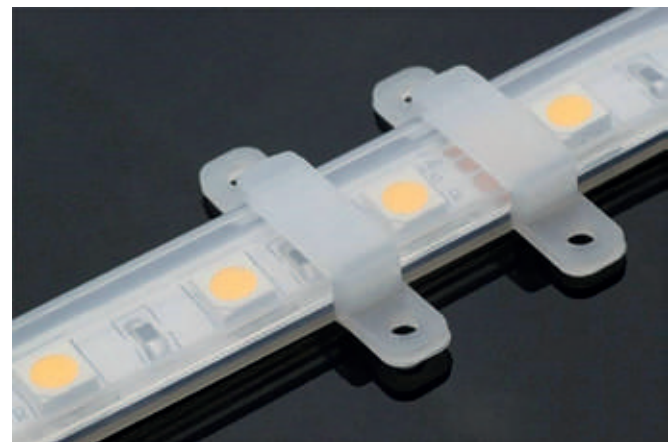

### Clip

20.041 silicone  
20.077 silicone



### Silicone for waterproofing

22.138 opal 45ml  
22.140 transparent 45ml



How to bend



# Big Profiles



A wide range of large and medium sized profiles used to manufacture surface, hanging, recessed luminaires or wall lamps.

Our main models are available with our exclusive IP65 “easy-ON” system. Both profile and cover are also available in lengths of up to 6 metres in one single piece.

We also offer models with trellis covers, optics, 3-phase rails for spotlights, recessed and assymetrical lighting.

# led profile by Luz Negra

System with front removable tray which permits easy access to the led strip and power supply, therefore allowing very fast and simple maintenance.

Up&Down cover available in transparent or frosted white.

Safety cable which fixes the removable tray to the profile and also making maintenance easier.

Vossloh-Schwabe power supply with Dali, 1-10V or PUSH controllers, offering a 5 year guarantee.

Aluminium front removable tray with triple safety system (clipping of cover, safety cable and screw).

"easy-ON" IP65 cover (European patent), available in opal white, transparent microprism and Black&White.

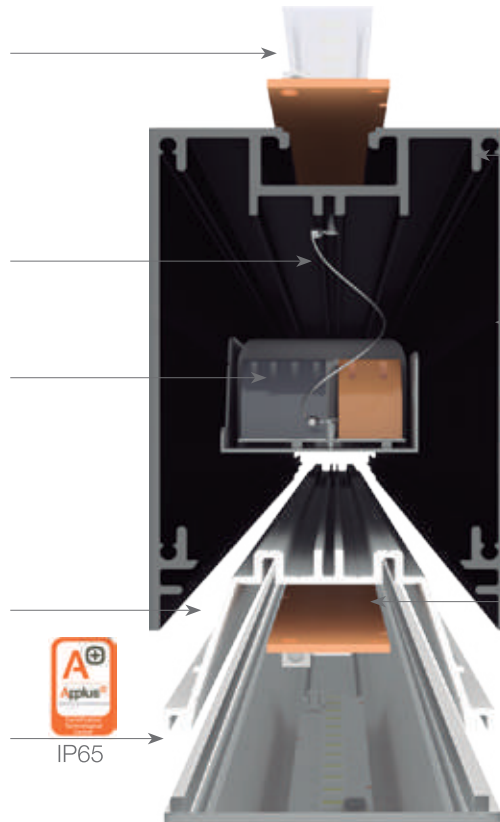

Internal side cavities for holding profile joints and for the corner brackets in the case of requiring luminaires with angles.

Aluminium profile (98% purity), both in a lacquered and textured finishing (Qualicoat), available in black or white. Also available in silver anodised (Qualanod) of 15 microns.

Profiles and covers up to 6 metres with no joints.

Rigid led strip (Vossloh-Schwabe) for Up&Down lighting, offering constant current and up to 9000 lumens per metre (170 Lm/W). We offer a 5 year guarantee.

## Front removable tray system with triple fall protection (safety anchorage)

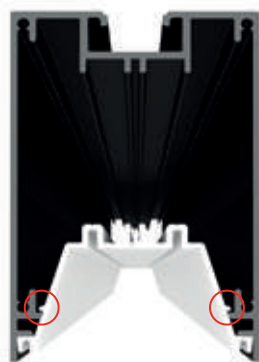

Profile clipping with profile tray

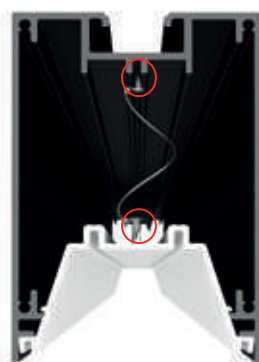

Safety cable to hold tray to profile

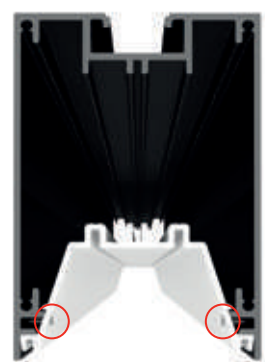

Pin screw from tray to profile



Aluminium profiles with our “easy-ON” system, offering an IP65 and designed for hanging, surfaces and embedding.

Front removable tray with triple safety system (except “Mini” models).

MOSCU  
MAGNUM



MUNICH  
MAGNUM



MOSCU  
MAGNUM  
SLIM



MUNICH  
MAGNUM  
SLIM



MOSCU  
MINI



MUNICH  
MINI

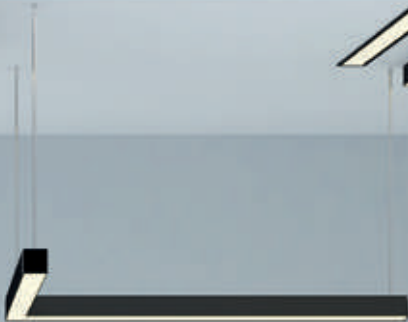

MOSCU  
MINI

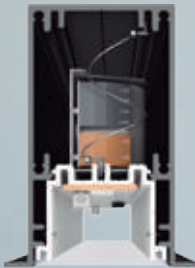

MOSCU  
MAGNUM  
SLIM

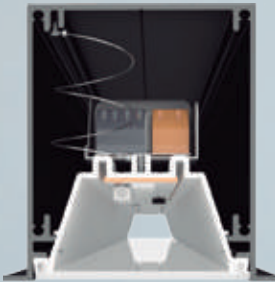

MOSCU  
MAGNUM



MUNICH  
MINI



MUNICH  
MAGNUM  
SLIM



MUNICH  
MAGNUM

A minimalist interior scene with a long, narrow, light-colored table. Four round, dark-colored plates are arranged in a row on the table, with a thin yellow line running through the center. A single, large, teardrop-shaped pendant light hangs from the ceiling, featuring a black top section and a gold-colored, tapered body. The background is a bright, white space with a large window or opening.

big profiles for surfaces and hanging





MÜNICH  
MINI

192



MÜNICH  
MAGNUM  
SLIM

194

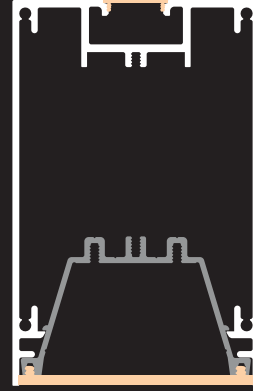

MÜNICH  
MAGNUM

196

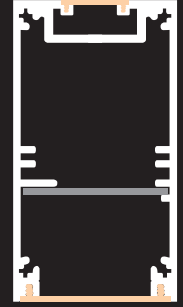

MÜNICH  
SLIM

198

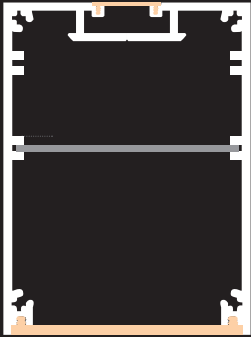

MÜNICH

200

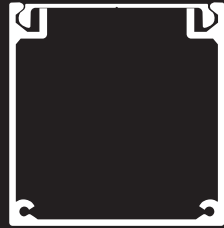

BOX

202

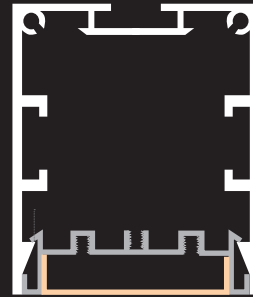

GALES  
with OPTIC

203

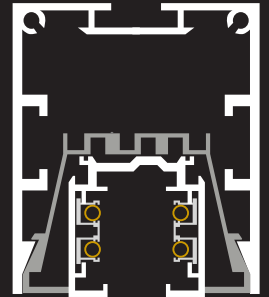

GALES with  
3-phase rail

204

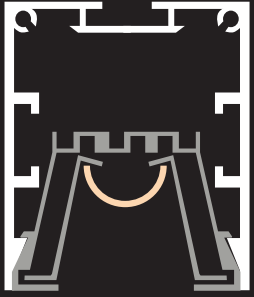

GALES  
with tray and  
trellis

205



GALES with  
RECESSED  
TRAY

206

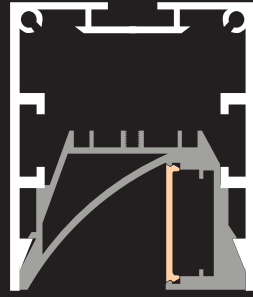

GALES  
ASYMMETRIC

207



SICILIA

208



HOUSTON

210



BRUSELAS

211



GALES  
with reflector  
and optic

211A



KAZAN  
211C

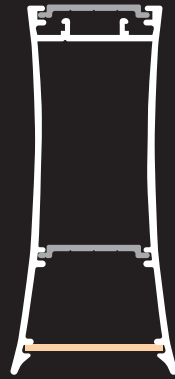

LOLA  
211E

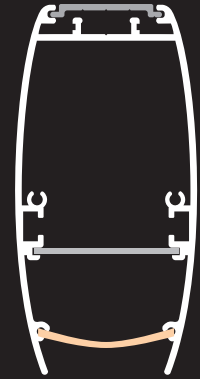

RICARDO  
211G

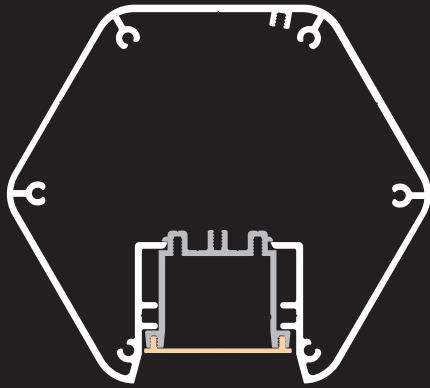

PACO  
211I

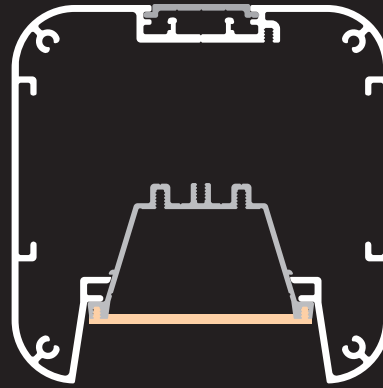

ANTONIO  
211K

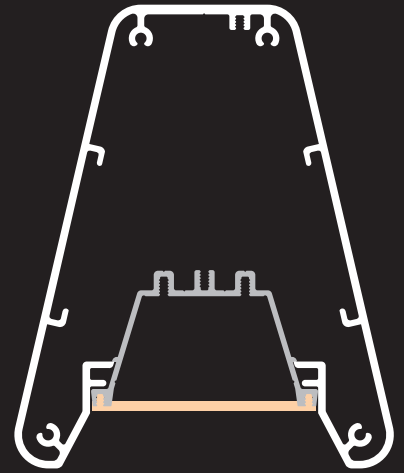

CARMEN  
211M

# led profile by Luz Negra

Our PROFESSIONAL led profile series for surfaces/hanging applications is manufactured in high purity aluminium. It is suitable for using on ceilings or for hanging luminaires and even on walls.

This profile can be combined with our "easy-ON" cover, which offers a waterproofing of IP65 to the luminaire, which is extremely useful in areas with high humidity levels.

We have also available Black&White cover, transparent or frosted microprism which improve glare and UGR levels.

Both profile and cover are available in bars of 6m length, allowing us to carry out long projects with no joints.

**We offer 10 years of guarantee on profiles and 4 years of guarantee on covers.**

## MUNICH MINI



IP65

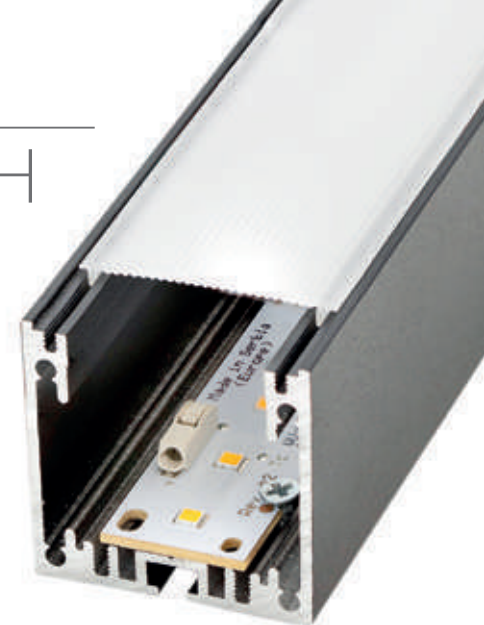

Scale 1:1

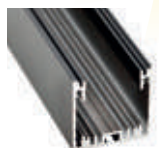
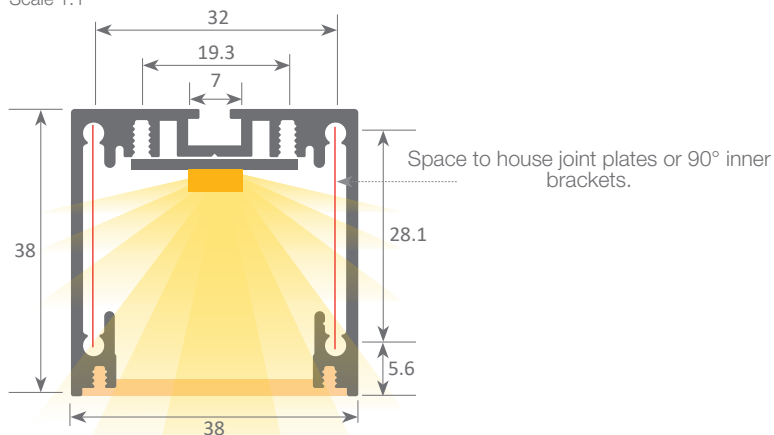

### Aluminium profile

16.002	anodised silver	6m
16.003	lacquered black	6m
16.004	lacquered white	6m



### Aluminium endcaps

19.228	anodised silver
19.229	lacquered textured black
19.230	lacquered textured white



### 90° angle bracket

22.035	aluminium	set of 2 units
--------	-----------	----------------



### 120° angle bracket

22.004	steel
--------	-------



### "easy-ON" polycarbonate cover

18.070	frosted	6m
18.071	transparent microprism	6m
18.072	frosted microprism	6m
18.073	Black&White	6m



### Hanging kit

21.001	chrome	set of 2 units
21.002	white	set of 2 units
21.003	black	set of 2 units



### Joining plate

22.034	aluminium	set of 2 units
--------	-----------	----------------



### Flat bracket

22.058	aluminium	set of 2 units
--------	-----------	----------------



Patente Europea  
Nº.: 13156605.1

Aluminium alloy extrusion process in accordance with: ISO 9001:2008 - ISO 14001 / Tolerances: UNE-EN 755-9 / UNE-EN 12020-2  
Theoretical weight: 0.835kg / Alloy: 6063 / Perimeter: 352mm / Anodising minimum: 15 microns  
Purity aluminium: 95-98% / Treatment: T-5 / Covers: Fireproof V0



# led profile by Luz Negra

Our PROFESSIONAL led profile series for surfaces/hanging applications is manufactured in high purity aluminium and silver anodised. Its inner tray (where we can find the led and the power supply) can be removed from the front which means easy maintenance. It is suitable for hanging, surfaces and walls (providing Up&Down lighting); drivers can be housed inside. This profile can be combined with a white frosted cover ("easy-ON" system), to achieve a waterproofing of IP65 (very necessary in damp zones). We also have available Black&White covers and also microprism versions in transparent or frosted, which improve glare and UGR levels. Both profile and covers are available in lengths of 6m, allowing us to carry out long installations without joints.

**We offer a 10 year guarantee on the profiles and 4 year guarantee on the covers.**

## MUNICH MAGNUM SLIM



IP65

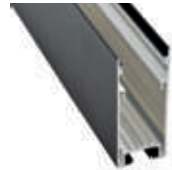

### Aluminium profile

17.004	anodised silver	6m
17.005	lacquered white	6m
17.006	lacquered black	6m



### Aluminium tray

15.007	lacquered white	6m
--------	-----------------	----



### "easy-ON" polycarbonate cover (Down)

18.070	frosted	6m
18.071	transparent microprism	6m
18.072	frosted microprism	6m
18.073	Black&White	6m



### Aluminium endcaps with hole

19.234	anodised silver
19.235	lacquered textured white
19.236	lacquered textured black



### Methacrylate cover

18.014	transparent	2m
18.015	frosted	2m
18.016	transparent	6m
18.017	frosted	6m



### Hanging kit

21.001	chrome	set of 2 units
21.002	white	set of 2 units
21.003	black	set of 2 units



### Safety cable

22.039	steel 18cm
--------	------------

### Polycarbonate cover (UP)

18.116	opal	2m
18.146	frosted	2m
18.148	opal	2m
18.115	opal	6m
18.145	frosted	2m
18.147	opal	2m

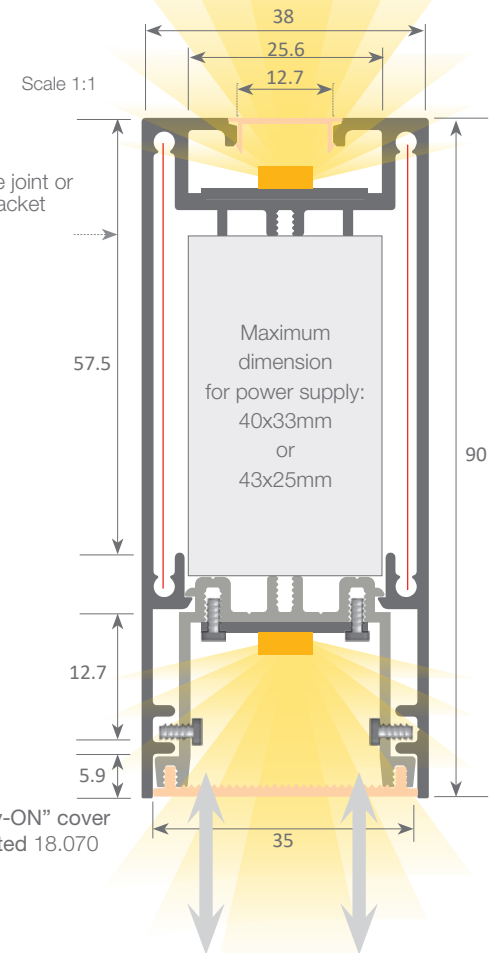

System with front removable tray which permits easy access to the led strip and power supply, therefore allowing very fast and simple maintenance of the electrical installation.



Patente Europea  
Nº.: 13156605.1

Aluminium alloy extrusion process in accordance with: ISO 9001:2008 - ISO 14001 / Tolerances: UNE-EN 755-9 / UNE-EN 12020-2 / Theoretical weight: 1.464Kg / Alloy: 6063 / Perimeter: 483mm / Anodising minimum: 15 microns Purity aluminium: 95-98% / Treatment: T-5 / Covers: Fireproof VØ

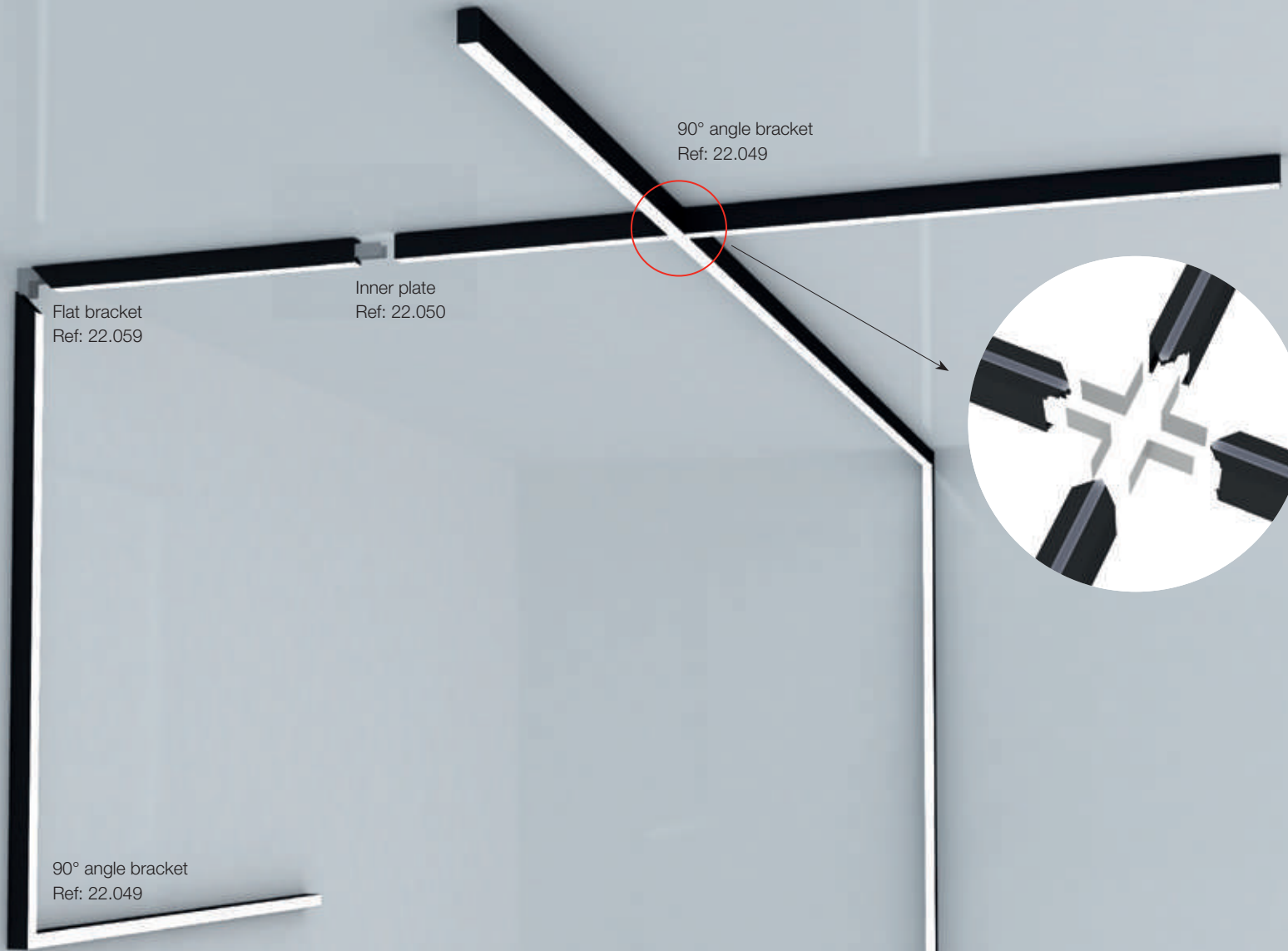

**90° angle bracket**  
22.049 aluminium set of 2 units



**Flat bracket**  
22.059 aluminium set of 2 units



**Joining plate**  
22.050 aluminium set of 2 units

Our PROFESSIONAL led profile series for surfaces/hanging applications is manufactured in high purity aluminium and silver anodised. Its inner tray (where we can find the led and the power supply) can be removed from the front which means easy maintenance. It is suitable for hanging, surfaces and walls (providing Up&Down lighting); drivers can be housed inside. This profile can be combined with a white frosted cover ("easy-ON" system), to achieve a waterproofing of IP65 (very necessary in damp zones). We also have available microprism covers both in transparent and frosted, which improve glare and UGR levels. Both profile and covers are available in lengths of 6m, allowing us to carry out long installations without joints.

**We offer a 10 year guarantee on the profiles and 4 year guarantee on the covers.**



#### Aluminium profile

16.008	anodised silver	6m
16.009	lacquered white	6m
16.010	lacquered black	6m



#### "easy-ON" polycarbonate cover (Down)

18.074	frosted	6m
18.075	transparent microprism	6m
18.076	frosted microprism	6m



#### Methacrylate cover

18.014	transparent	2m
18.015	frosted	2m
18.016	transparent	6m
18.017	frosted	6m

#### Polycarbonate cover (UP)

18.116	opal	2m
18.146	frosted	2m
18.148	opal	2m
18.115	opal	6m
18.145	frosted	2m
18.147	opal	2m



#### Aluminium tray

14.007	lacquered white	6m
14.042	lacquered black	6m



#### Reflector with 4 module optics

46.046	white 50° optic
46.047	black 50° optic
46.048	white 80° optic
46.049	black 80° optic

#### Reflector with 7 module optics

46.050	white 50° optic
46.051	black 50° optic
46.052	white 80° optic
46.053	black 80° optic



#### Aluminium endcaps

19.243	anodised silver
19.244	lacquered textured white
19.245	lacquered textured black



#### Hanging kit

21.001	chrome	set of 2 units
21.002	white	set of 2 units
21.003	black	set of 2 units

## MUNICH MAGNUM



IP65

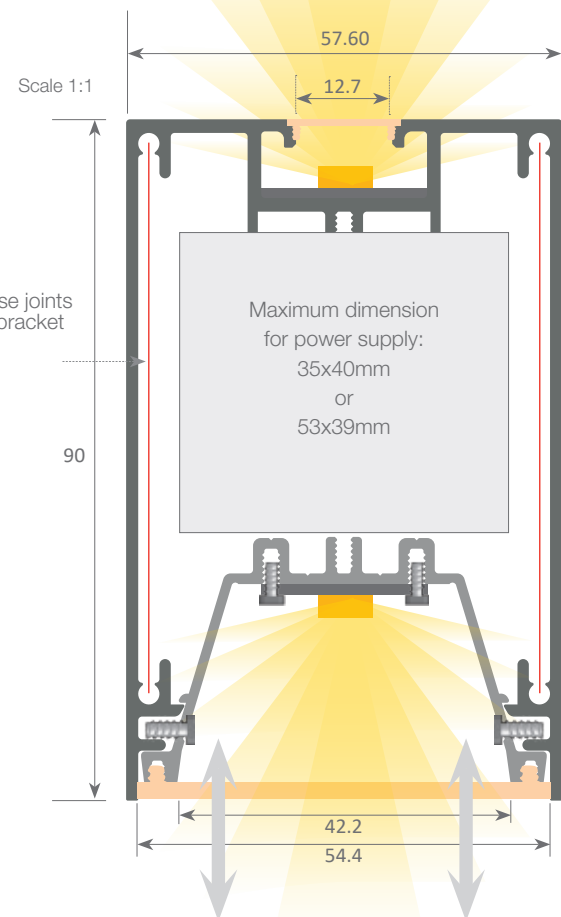

System with front removable tray which permits easy access to the led strip and power supply, therefore allowing very fast and simple maintenance of the electrical installation.



Patente Europea  
Nº.: 13156605.1

Aluminium alloy extrusion process in accordance with: ISO 9001:2008 - ISO 14001 / Tolerances: UNE-EN 755-9 / UNE-EN 12020-2 / Theoretical weight: 1.917kg / Alloy: 6063 / Perimeter: 643mm / Anodising minimum: 15 microns / Purity aluminium: 95-98% / Treatment: T-5 / Covers: Fireproof VØ



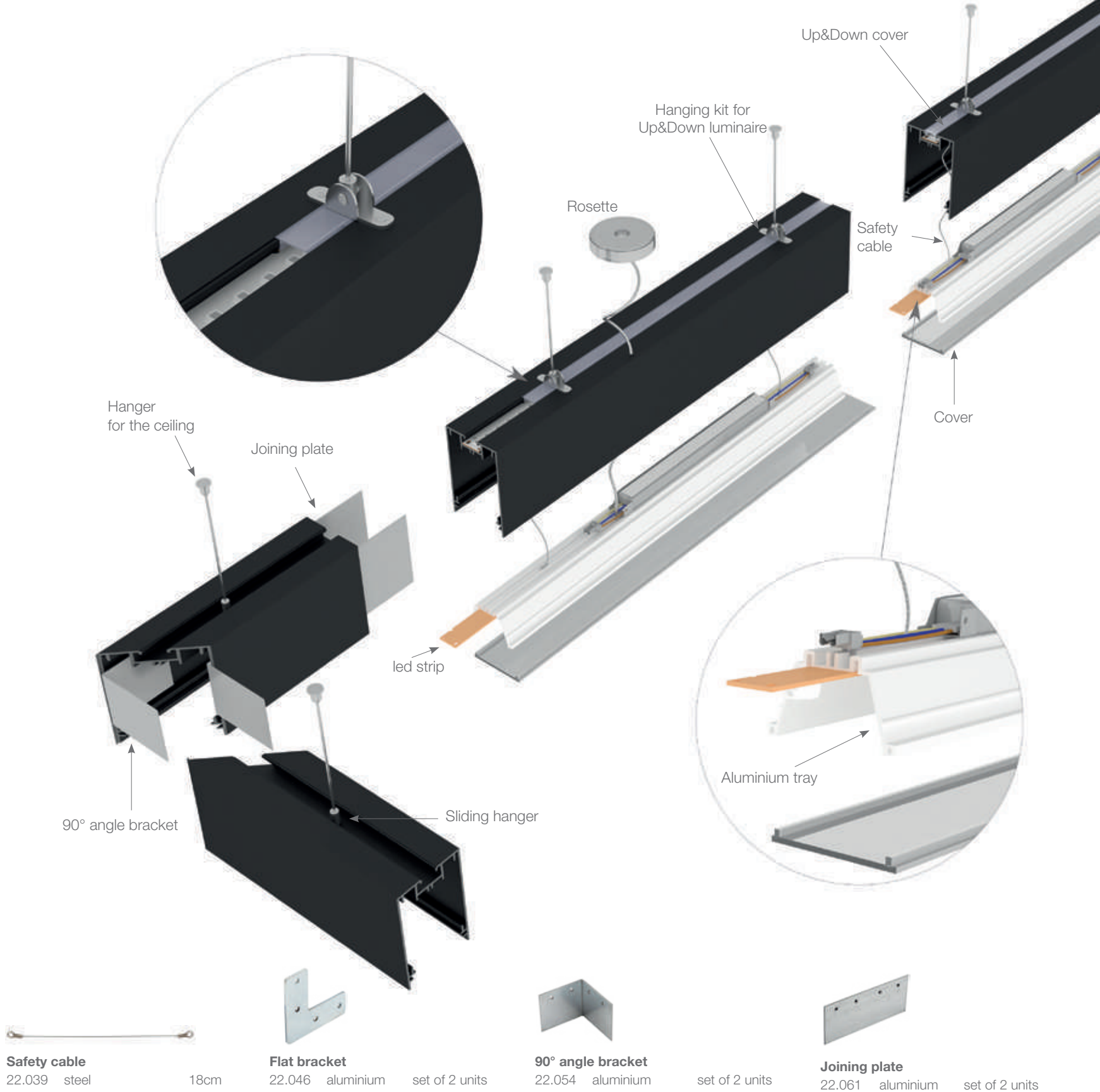

**Safety cable**  
22.039 steel 18cm

**Flat bracket**  
22.046 aluminium set of 2 units

**90° angle bracket**  
22.054 aluminium set of 2 units

**Joining plate**  
22.061 aluminium set of 2 units

# led profile by Luz Negra

Our PROFESSIONAL led profile series for surfaces/hanging applications is manufactured in high purity aluminium and silver anodised. It is also supplied in lacquered white or textured black and ideal for using on ceilings or for hanging luminaires and even on walls (providing Up&Down lighting but only for the silver anodised profile). Drivers can be housed inside.

This profile can be combined with our "easy-ON" frosted white cover, which offers an IP65 to the luminaire, which is extremely useful in areas with high humidity levels. We also have available transparent and frosted microprism covers which improve glare and UGR levels.

Both profile and cover are available in 6m lengths, allowing us to carry out long installations with no joints.

**We offer a 10 year guarantee on the profiles and a 4 year guarantee on the covers.**

## MUNICH SLIM



IP65



### Aluminium profile

17.001	anodised silver	6m
17.002	lacquered black	6m
17.003	lacquered white	6m



### Inner plate

22.036	aluminium 200cm
--------	-----------------



### "easy-ON" polycarbonate cover (Down)

18.070	frosted	6m
18.071	transparent microprism	6m
18.072	frosted microprism	6m
18.073	Black&White	6m



### Aluminium endcaps without hole

19.231	anodised silver
19.232	lacquered textured white
19.233	lacquered textured black



### "easy-ON" polycarbonate cover (Up)

18.001	transparent	2m
18.002	opal	2m
18.003	frosted	2m
18.004	transparent	6m
18.005	opal	6m
18.006	frosted	6m
18.134	frosted	60m



### Hanging kit

21.001	chrome	set of 2 units
21.002	white	set of 2 units
21.003	black	set of 2 units

Scale 1:1

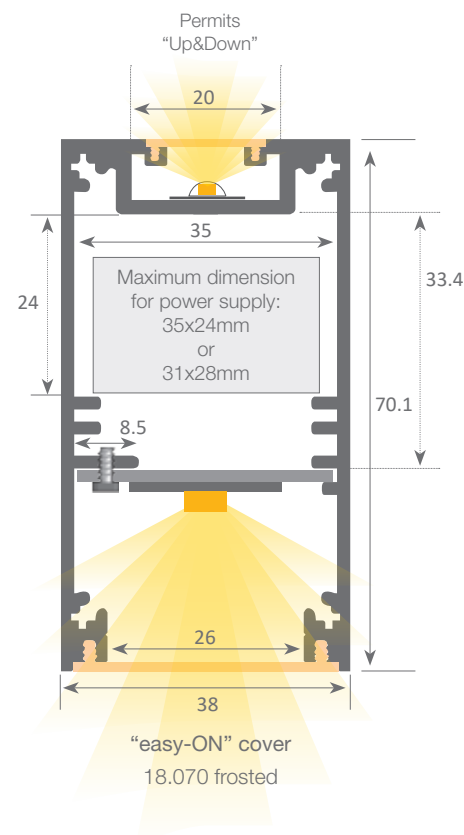

Patente Europea  
Nº.: 13156605.1

Aluminium alloy extrusion process in accordance with: ISO 9001:2008 - ISO 14001 / Tolerances: UNE-EN 755-9 / UNE-EN 12020-2  
Theoretical weight: 1.16 Kg / Alloy: 6063 / Perimeter: 524mm / Anodising minimum: 15 microns  
Purity aluminium: 95-98% / Treatment: T-5 / Covers: Fireproof V0



Made with Múnich Slim led Profile  
Cortesy of singular.design

# led profile by Luz Negra

Our PROFESSIONAL led profile series for surfaces/hanging applications is manufactured in high purity aluminium and silver anodised. It is also supplied in lacquered white or textured black and ideal for using on ceilings or for hanging luminaires and even on walls (providing Up&Down lighting). Drivers can be housed inside.

This profile can be combined with our "easy-ON" frosted white cover, which offers an IP65 to the luminaire, which is extremely useful in areas with high humidity levels (in this case, not suitable for our Black&White profiles). We also have available transparent and frosted microprism covers which improve glare and UGR levels.

Both profile and cover are available in 6m lengths, allowing us to carry out long installations without joints.

**We offer a 10 year guarantee on the profiles and a 4 year guarantee on the covers.**

## MUNICH



IP65



### Aluminium profile

16.005	anodised silver	6m
16.006	lacquered black	6m
16.007	lacquered white	6m



### Inner plate 200 cm

22.190	aluminium
22.051	for 40mm optic rigid strips



### "easy-ON" polycarbonate cover (Down)

18.074	frosted	6m
18.075	transparent microprism	6m
18.076	frosted microprism	6m



### Plastic endcaps without hole

19.240	grey
19.241	black
19.242	white



### "easy-ON" polycarbonate cover (Up)

18.001	transparent	2m
18.002	opal	2m
18.003	frosted	2m
18.004	transparent	6m
18.005	opal	6m
18.006	frosted	6m
18.134	frosted	60m



### Aluminium endcaps

19.237	silver anodised
19.238	lacquered black
19.239	lacquered white



### Safety cable

22.039	steel	18cm
--------	-------	------



### Hanging kit

21.001	chrome	set of 2 units
21.002	white	set of 2 units
21.003	black	set of 2 units

Scale 1:1

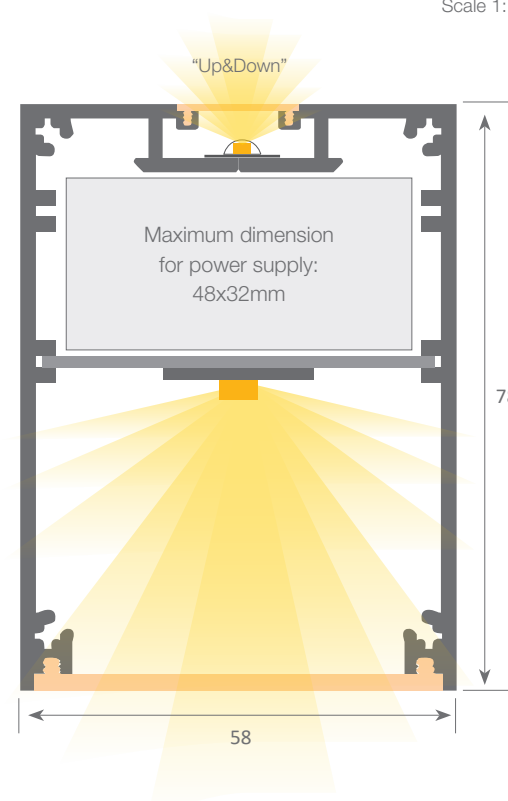

Patente Europea  
Nº.: 13156605.1

Aluminium alloy extrusion process in accordance with: ISO 9001:2008 - ISO 14001 / Tolerances: UNE-EN 755-9 / UNE-EN 12020-2  
Theoretical weight: 1.350Kg / Alloy: 6063 / Perimeter: 604mm / Anodising minimum: 15 microns  
Purity aluminium: 95-98% / Treatment: T-5 / Covers: Fireproof V0

## “UGR” covers



TRELIS cover



SMOOTH cover



MICROPRISMATIC cover



STRIPED LINE cover

### New microprismatic covers

The type of cover we choose for a luminaire doesn't only affect its appearance or its light transmission capacities, but also the Unified Glare Ratings (whose acronym is UGR).

#### Formula for the calculation of the UGR

$$UGR = 8 \log \left[ \frac{0.25}{L_b} \sum \left( \frac{L^2 \omega}{p^2} \right) \right]$$

The UGR, (Unified Glare Rating) quantifies the amount of glare inflicted by a source of light by applying a numerical value which ranges between 10 and 30 (where 10 defines an absence of glare, while on other hand, 30 is the cipher applied when glare reaches its peak value).

Some projects require an in-depth knowledge of this concept in order to be executed.

In theory, glare values depend on the quantity, position, brightness and size of the glaring light sources and the types of lighting which the human eye is accustomed to. In the case of luminaires which have lamps fully or partially visible according to the range of critical viewing angles, not only should they be limited to their average brightness, but also the lamps should have adequate covers.

Standard covers (smooth) may not comply with UGR values on the basis of current standards (see pages 346 and 347).

Luz Negra's new transparent, frosted and opal microprismatic covers manage to reduce the UGR, obtaining lower glare rates and at the same time scattering the luminaire's inner light. Therefore we achieve almost the double amount of light transmission than with an opal white cover.

Here at Luz Negra we can also supply metal covers, also referred to as trellis covers, which optimize the use of light, while also improving considerably the UGR rating.

Here in our headquarters at Barcelona we have a laboratory which offers a Dark Room and also a goniometre, while at the same time it is equipped with all the technical means necessary to carry out UGR measurements.



### New microprismatic transparent covers



# led profile by Luz Negra

## BOX

A linear led profile, consisting of a base and aluminium cover, whose objective is to conceal accessories like power supplies, controllers, connection strips, etc. It is mainly used for ceiling mounting in order to hide the power supplies in the case of smaller luminaires which aren't big enough to house them inside their structure.

**We offer a 2 year guarantee.**



Scale 1:1

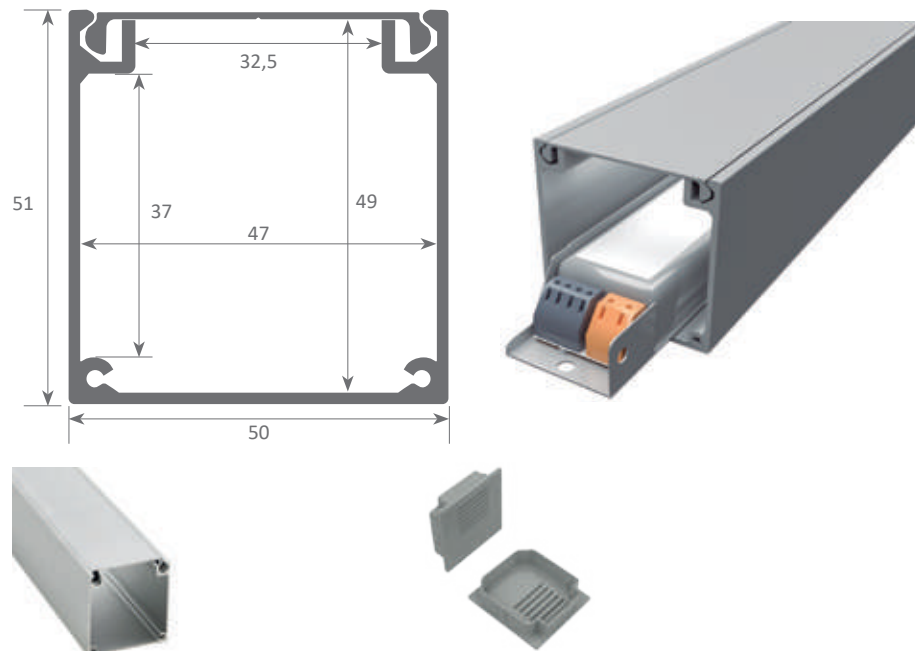

### Aluminium profile

16.001	anodised silver	3m
16.039	lacquered black	3m
16.040	lacquered white	3m

### Plastic vented endcaps

19.212	grey
19.346	black
19.347	white

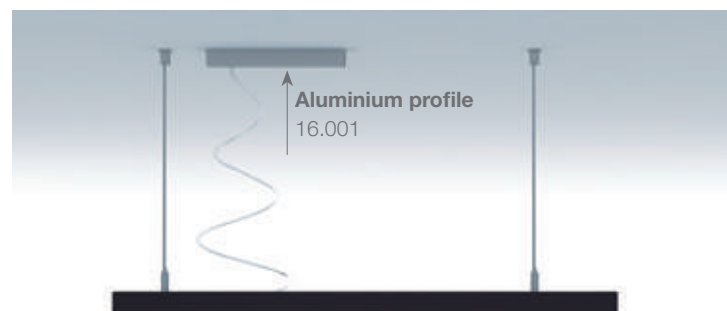

## GALES with OPTIC

Our PROFESSIONAL led profile series for surfaces/hanging applications is manufactured in high purity aluminium and lacquered in textured white, black and grey. Drivers can be housed inside.

This profile can be used with different types of optics (see page 307).

The internal tray allows us to screw the rigid led strip on one side and enables us to house the power supply on the other. At the same time this tray can be removed from the front which means easy maintenance. For safety measures, we recommend the fixing of a braided cable from the profile base to the dissipation tray. Both profile and cover are available in 3.4 metre lengths.

**We offer a 2 year guarantee on the profiles and covers.**

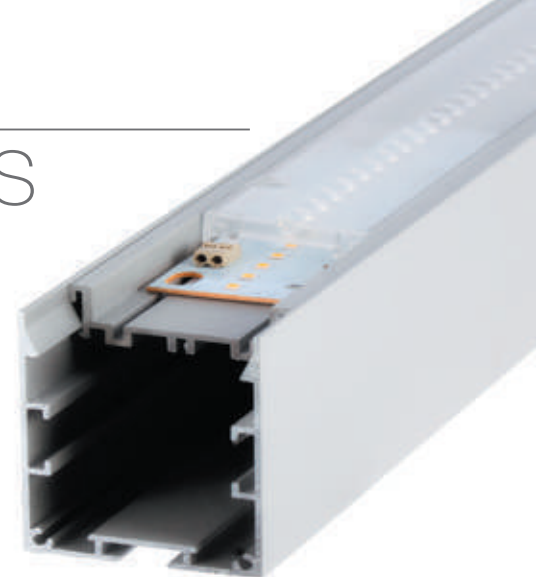

### Aluminium profile

16.011	lacquered grey	3.40m
16.012	lacquered white	3.40m
16.013	lacquered black	3.40m



### Internal tray

14.014	textured grey	3.40m
14.015	textured white	3.40m
14.026	textured black	3.40m



### Optic

See page 307



### Profile joints

22.044	steel	set of 2 units
--------	-------	----------------



### Aluminium endcaps

19.246	grey
19.247	white
19.248	black



### Hanging kit

21.001	chrome	set of 2 units
21.002	white	set of 2 units
21.003	black	set of 2 units



### Safety cable

22.039	steel	18cm
--------	-------	------

Scale 1:1

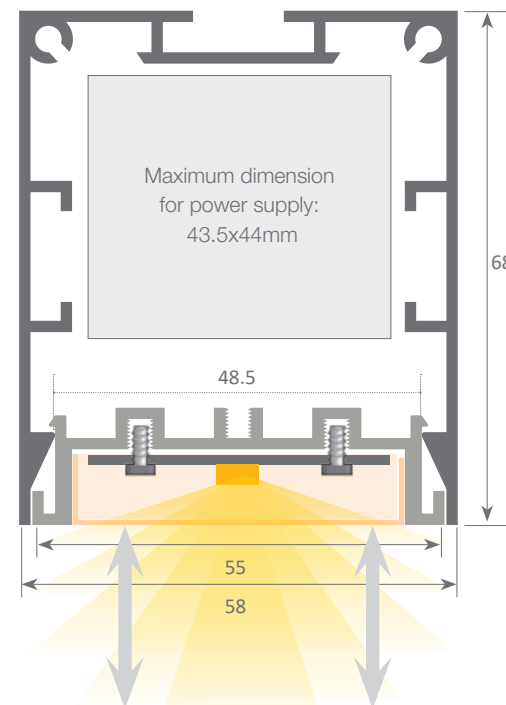

System with front removable tray which permits easy access to the led strip and power supply, therefore allowing very fast and simple maintenance of the electrical installation.



Aluminium alloy extrusion process in accordance with: ISO 9001:2008 - ISO 14001 / Tolerances defined by: UNE-EN 755-9 / UNE-EN 12020-2  
Theoretical weight: 1.126 Kg. / Alloy: 6063 / Perimeter: 514 / Anodising minimum: 15 microns  
Purity aluminium: 95-98% / Treatment: T-5

# led profile by Luz Negra

Our PROFESSIONAL led profile series for surfaces/hanging applications is manufactured in high purity aluminium and lacquered in white or textured black. Drivers can be housed inside.

The tray can be removed from the front which means easy maintenance. Also, this tray can be combined also with a "Global" 3 phase rail in order to hang spotlights. For safety measures, we recommend fixing a braided cable from the profile base to the tray. Both profile and cover are available in 3.4m lengths.

**We offer a 2 year guarantee on the profiles and covers.**

## GALES

with tray and "Global"  
3-phase rail



### Aluminium profile

16.012 lacquered white 3.40m  
16.013 lacquered black 3.40m



### Profile joints

22.044 steel set of 2 units



### Trellis

16.037 textured white 2m  
16.038 textured black 2m



### Aluminium tray

14.016 textured white 3.40m  
14.017 textured black 3.40m



### Aluminium endcaps

19.247 white  
19.248 black



### Hanging kit

21.001 chrome set of 2 units  
21.002 white set of 2 units  
21.003 black set of 2 units



### Safety cable

22.039 steel 18cm

Scale 1:1

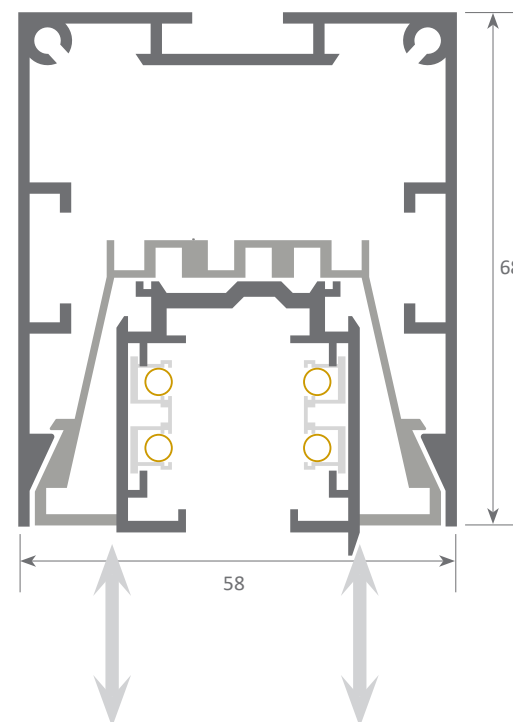

System with front removable tray which permits easy access to the led strip and power supply, therefore allowing very fast and simple maintenance of the electrical installation.



Aluminium alloy extrusion process in accordance with: ISO 9001:2008 - ISO 14001 / Tolerances defined by: UNE-EN 755-9 / UNE-EN 12020-2  
Theoretical weight: 1.202Kg / Alloy: 6060 / Perimeter: 552mm / Anodising minimum: 15 microns  
Purity aluminium: 95-98% / Treatment: T-5



# led profile by Luz Negra

Our PROFESSIONAL led profile series for surfaces/hanging applications is manufactured in high purity aluminium and lacquered in white or textured black. Drivers can be housed inside.

The internal tray allows us to screw the rigid led strip on one side and enables us to house the power supply on the other. At the same time this tray can be removed from the front which means easy maintenance. For safety measures, we recommend fixing a braided cable from the profile base to the tray. Both profile and cover are available in 3.4m lengths.

**We offer a 2 year guarantee on the profiles and covers.**

## GALES

with tray and trellis



### Aluminium profile

16.012 lacquered white 3.40m  
16.013 lacquered black 3.40m



### Aluminium tray

14.016 textured white 3.40m  
14.017 textured black 3.40m



### Trellis

16.016 textured white 1.124m  
16.017 textured black 1.124m



### Profile joints

22.044 steel set of 2 units



### Aluminium endcaps

19.247 white  
19.248 black



### Hanging kit

21.001 chrome set of 2 units  
21.002 white set of 2 units  
21.003 black set of 2 units



### Safety cable

22.039 steel 18cm

Scale 1:1

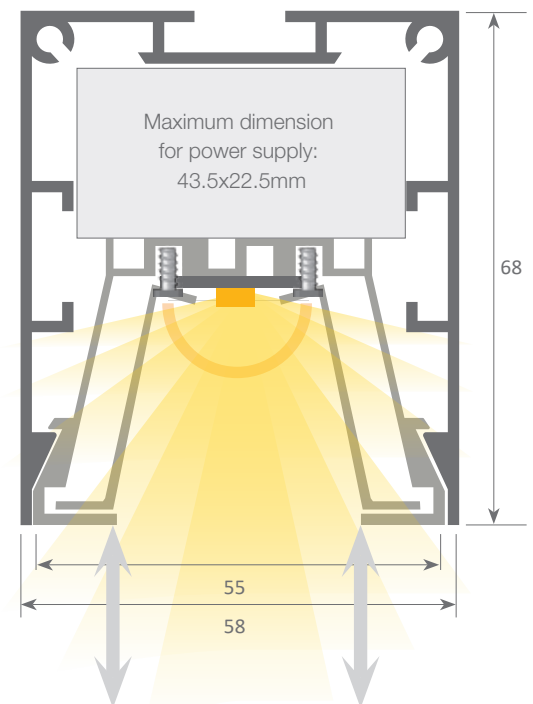

System with front removable tray which permits easy access to the led strip and power supply, therefore allowing very fast and simple maintenance of the electrical installation.



Aluminium alloy extrusion process in accordance with: ISO 9001:2008 - ISO 14001 / Tolerances defined by: UNE-EN 755-9 / UNE-EN 12020-2  
Theoretical weight: 1.202Kg / Alloy: 6060 / Perimeter: 552mm / Anodising minimum: 15 microns  
Purity aluminium: 95-98% / Treatment: T-5

# led profile by Luz Negra

Our PROFESSIONAL led profile series for surfaces/hanging applications is manufactured in high purity aluminium and lacquered in textured white, black and grey. Drivers can be housed inside. The internal tray allows us to screw the rigid led strip on one side and enables us to house the power supply on the other. At the same time this tray can be removed from the front which means easy maintenance. For safety measures, we recommend the fixing of a braided cable from the profile base to the dissipation tray. Both profile and cover are available in 3.4 metre lengths.

**We offer a 2 year guarantee on the profiles and covers.**

## GALES with RECESSED TRAY

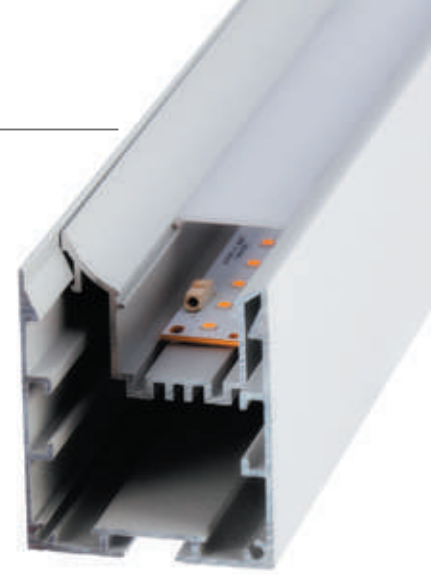

### Aluminium profile

16.011	lacquered grey	3.40m
16.012	lacquered white	3.40m
16.013	lacquered black	3.40m



### Recessed tray

14.018	textured grey	3.40m
14.019	textured white	3.40m
14.025	textured black	3.40m



### Polycarbonate cover

18.079	frosted	3.40m
--------	---------	-------



### Profile joints

22.044	steel	set of 2 units
--------	-------	----------------



### Aluminium endcaps

19.246	grey
19.247	white
19.248	black



### Hanging kit

21.001	chrome	set of 2 units
21.002	white	set of 2 units
21.003	black	set of 2 units



### Safety cable

22.039	steel	18 cm
--------	-------	-------

Scale 1:1

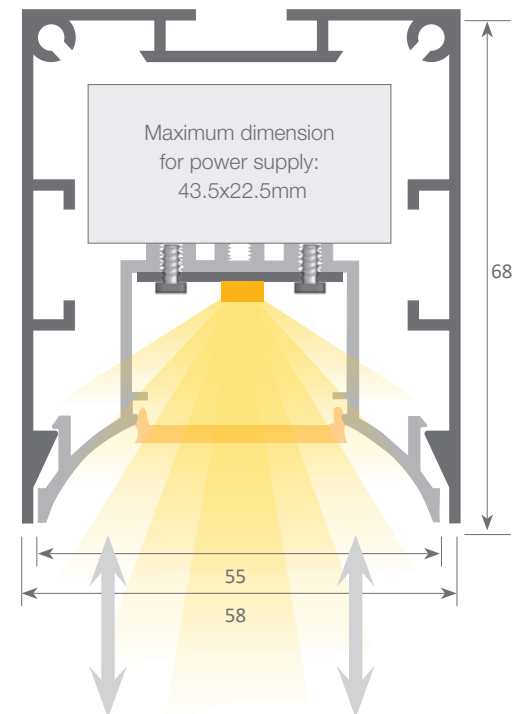

System with front removable tray which permits easy access to the led strip and power supply, therefore allowing very fast and simple maintenance of the electrical installation.



Aluminium alloy extrusion process in accordance with: ISO 9001:2008 - ISO 14001 / Tolerances defined by: UNE-EN 755-9 / UNE-EN 12020-2  
Alloy: 6060 / Anodising minimum: 15 microns / Purity aluminium: 95-98% / Treatment: T-5

# led profile by Luz Negra

Our PROFESSIONAL led profile series for surfaces/hanging applications is manufactured in high purity aluminium and lacquered in textured white, black and grey. Drivers can be housed inside. The internal tray allows us to screw the 20mm rigid led strip on one side and enables us to house the power supply on the other. At the same time this tray can be removed from the front which means easy maintenance. For safety measures, we recommend the fixing of a braided cable from the profile base to the dissipation tray. Both profile and cover are available in 3.4 metre lengths. **We offer a 2 year guarantee on the profiles and covers.**

## GALES ASYMMETRIC



### Aluminium profile

16.012	lacquered white	3.40m
16.013	lacquered black	3.40m
16.011	lacquered grey	3.40m



### Aluminium tray

14.022	textured white	3.40m
14.023	textured black	3.40m
14.024	textured grey	3.40m



### Polycarbonate cover

18.079	frosted	3.40m
--------	---------	-------



### Aluminium endcaps

19.246	grey
19.247	white
19.248	black



### Profile joints

22.044	steel	set of 2 units
--------	-------	----------------



### Hanging kit

21.001	chrome	set of 2 units
21.002	white	set of 2 units
21.003	black	set of 2 units



### Safety cable

22.039	steel	18cm
--------	-------	------

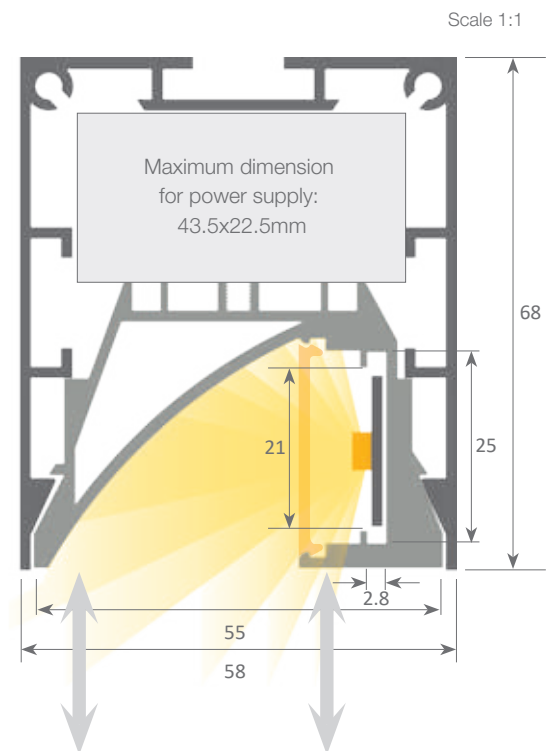

System with front removable tray which permits easy access to the led strip and power supply, therefore allowing very fast and simple maintenance of the electrical installation.



Aluminium alloy extrusion process in accordance with: ISO 9001:2008 - ISO 14001 / Tolerances defined by: UNE-EN 755-9 / UNE-EN 12020-2  
Theoretical weight: 1.202Kg / Alloy: 6060 / Perimeter: 552mm / Anodising minimum: 15 microns  
Purity aluminium: 95-98% / Treatment: T-5

# led profile by Luz Negra

Our PROFESSIONAL led profile series for hanging applications is manufactured in high purity aluminium and silver anodised, and provides Up&Down lighting. Drivers can be housed inside.

This profile can be combined with our "easy-ON" frosted white cover, which offers an IP65 to the luminaire, which is extremely useful in areas with high humidity levels. We also have available transparent and frosted microprisma covers which improve glare and UGR levels.

Both profile and cover are available in 6 metre lengths which means that long installations can be carried out without any joints.

**We offer a 10 year guarantee on the profiles and a 4 year guarantee on the covers.**

## SICILIA



IP65

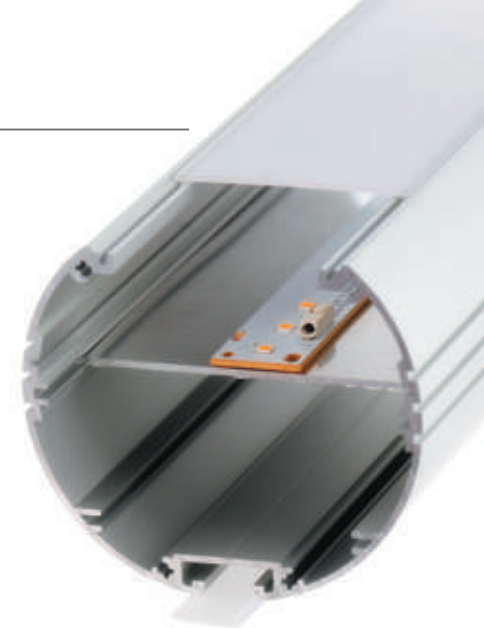

### Aluminium profile

13.021 anodised silver 6m



### Inner plate 200cm

22.055 wide  
22.056 narrow



### "easy-ON" polycarbonate cover (Down)

18.074 frosted 6m  
18.075 transparent microprism 6m  
18.076 frosted microprism 6m



### Aluminium endcaps

19.106 anodised silver



### "easy-ON" polycarbonate cover (Up)

18.001 transparent 2m  
18.002 opal 2m  
18.003 frosted 2m  
18.004 transparent 6m  
18.005 opal 6m  
18.006 frosted 6m  
18.134 frosted 60m



### Hanging kit

21.001 chrome set of 2 units  
21.002 white set of 2 units  
21.003 black set of 2 units

Scale 1:1

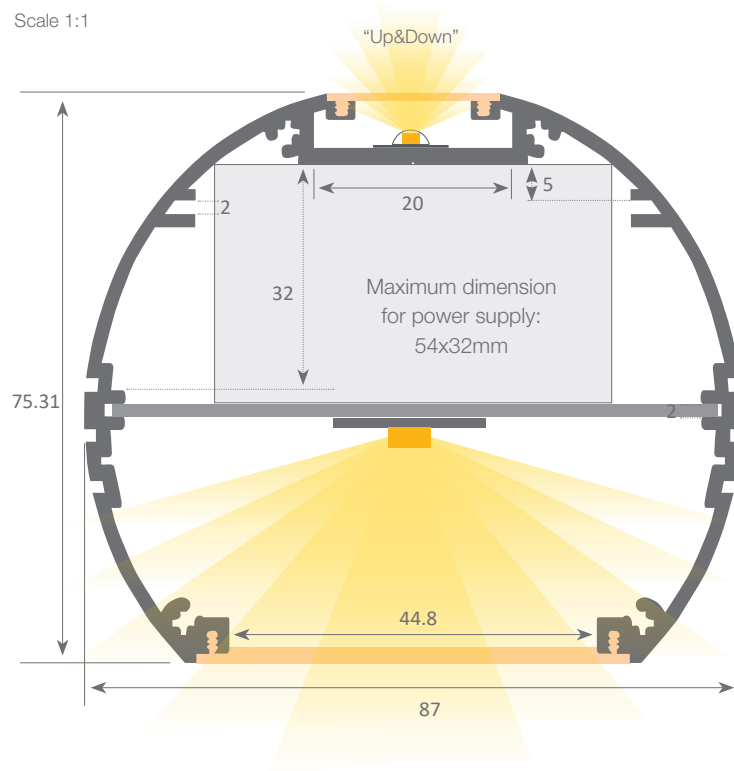

Patente Europea  
Nº.: 13156605.1

Aluminium alloy extrusion process in accordance with: ISO 9001:2008 - ISO 14001 / Tolerances defined by: UNE-EN 755-9 / UNE-EN 12020-2  
Theoretical weight: 1.539Kg / Alloy: 6063 / Perimeter: 627mm / Anodising minimum: 15 microns  
Purity aluminium: 95-98% / Treatment: T-5

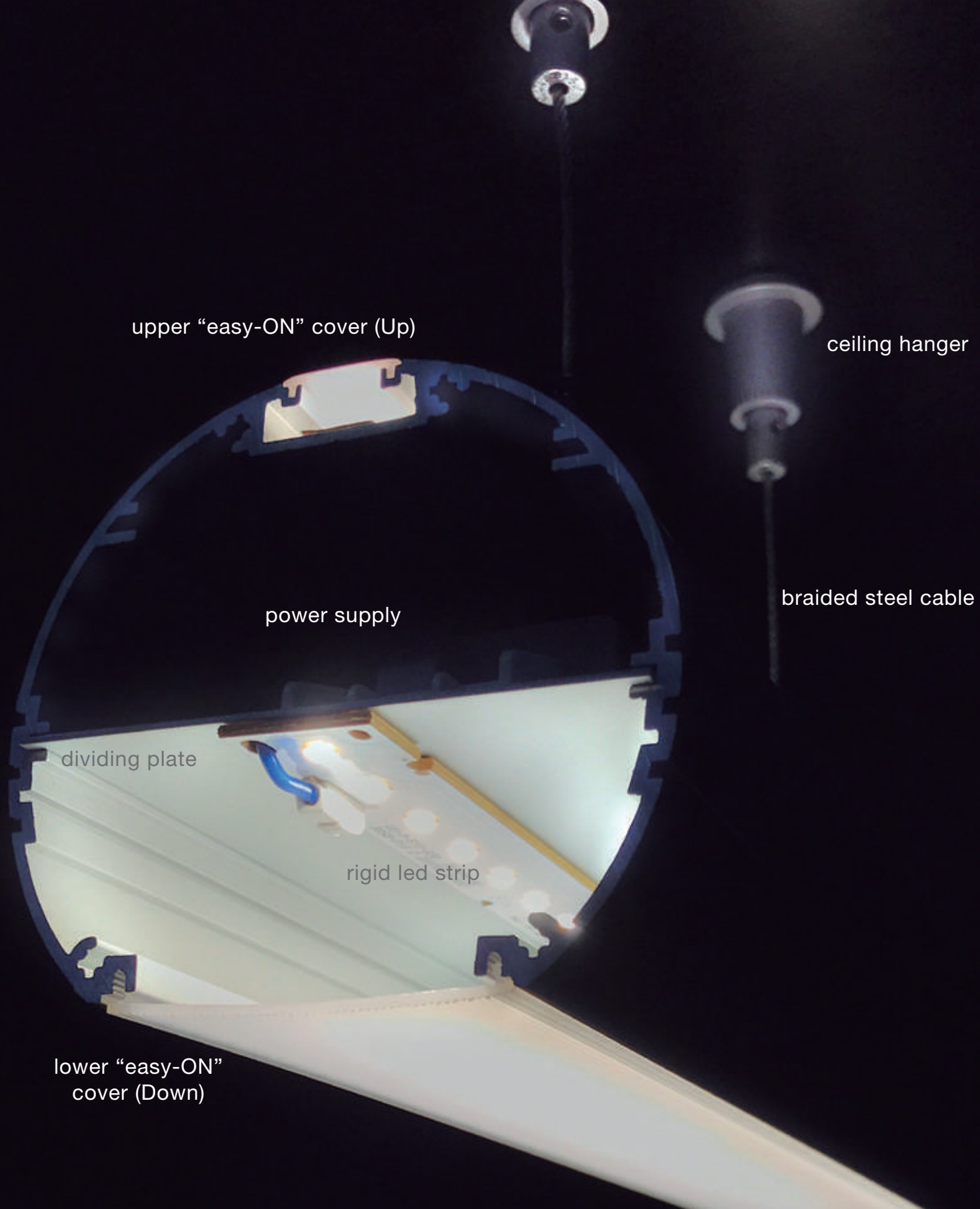

upper "easy-ON" cover (Up)

ceiling hanger

power supply

braided steel cable

dividing plate

rigid led strip

lower "easy-ON"  
cover (Down)

# led profile by Luz Negra

## HOUSTON

Our PROFESSIONAL led profile series for hanging applications is manufactured in high purity aluminium and silver anodised. Drivers cannot be housed inside. This profile, when combined with a very large opal white cover, offers a very high level of luminosity. Both profile and cover are available in 3 metre lengths.

**We offer a 2 year guarantee on our profiles and covers.**

Scale 1:1

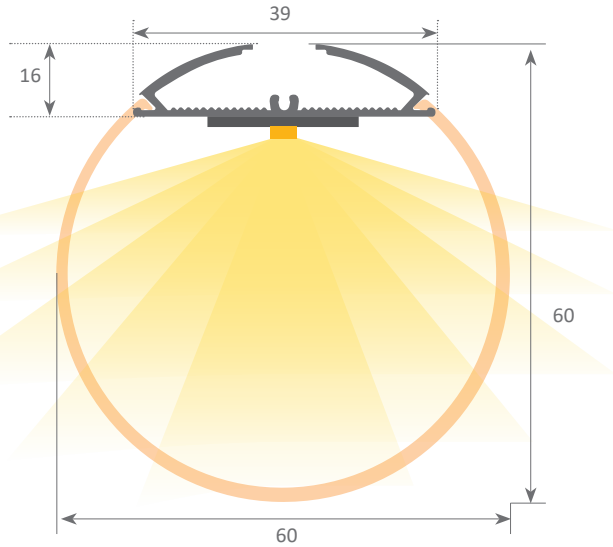

**Aluminium profile**  
13.022 anodised silver 3m



**Plastic endcaps**  
19.107 without hole



**Polycarbonate cover**  
18.069 opal 3m



**Hanging kit**  
21.001 chrome set of 2 units  
21.002 white set of 2 units  
21.003 black set of 2 units



Aluminium alloy extrusion process in accordance with: ISO 9001:2008 - ISO 14001 / Tolerances defined by: UNE-EN 755-9 / UNE-EN 12020-2  
Theoretical weight: 0.381Kg / Alloy: 6063 / Perimeter: 141.8mm / Anodising minimum: 15 microns  
Purity aluminium: 95-98% / Treatment: T-5 / Covers: Fireproof VØ

# led profile by Luz Negra

Our PROFESSIONAL led profile series for surfaces/hanging applications is manufactured in high purity aluminium and lacquered in textured white or grey. This is a very wide profile which permits us to install a double rigid led strip in order to achieve high levels of luminosity (especially indicated for shopping malls, supermarkets, etc.).

Drivers can be housed inside. The covers are available in frosted white. Both profile and cover are available in 3.4m lengths.

**We offer a 2 year guarantee on the profiles and covers.**

## BRUSELAS

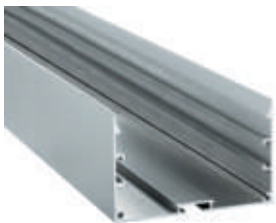
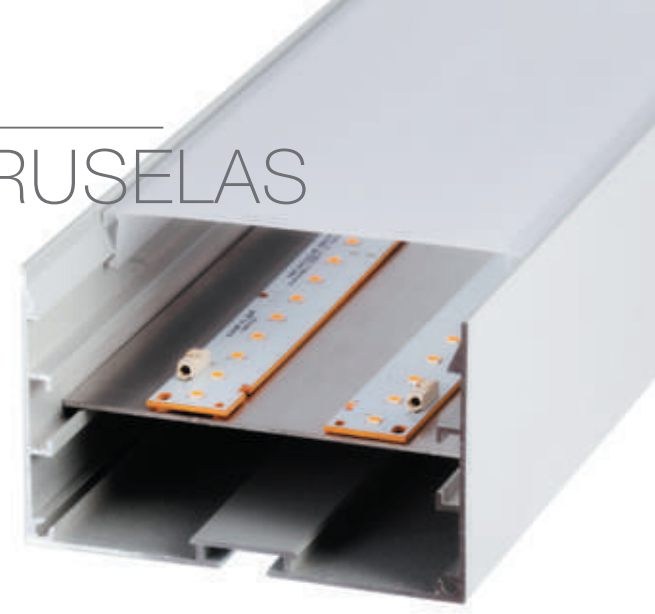

### Aluminium profile

16.014	textured grey	3.40m
16.015	textured white	3.40m
16.032	textured black	3.40m



### Inner plate

22.045	aluminium
--------	-----------



### Polycarbonate cover

18.080	frosted	3.40m
--------	---------	-------



### Aluminium endcaps

19.249	grey
19.250	white
19.350	black



### Profile joint

22.044	steel	set of 2 units
--------	-------	----------------



### Support plate

22.047	steel
--------	-------



### Hanging kit

21.001	chrome	set of 2 units
21.002	white	set of 2 units
21.003	black	set of 2 units

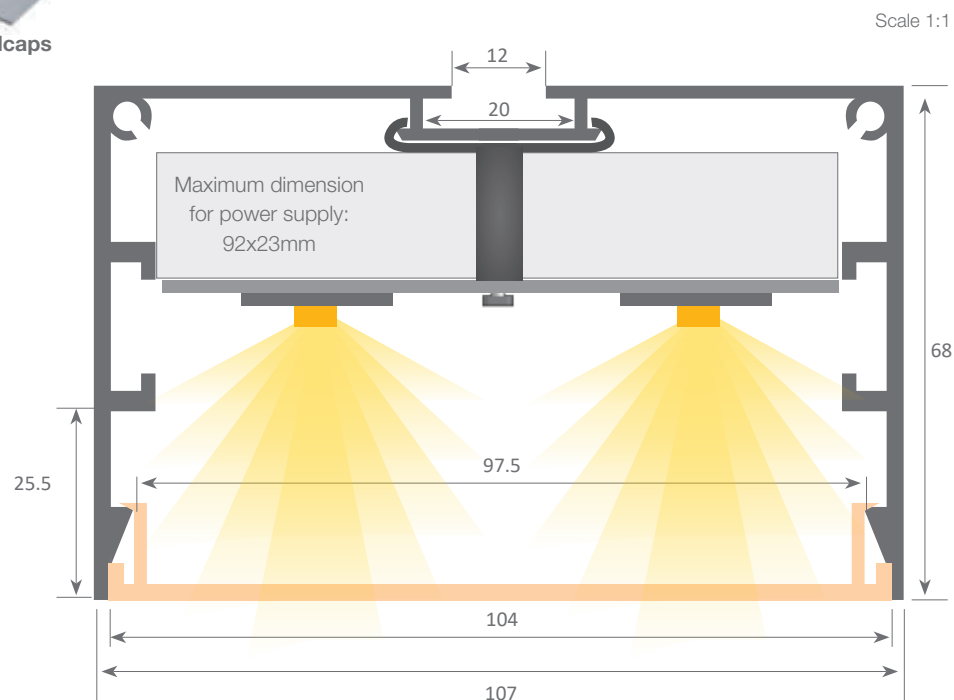

Aluminium alloy extrusion process in accordance with: ISO 9001:2008 - ISO 14001 / Tolerances defined by: UNE-EN 755-9 / UNE-EN 12020-2  
Theoretical weight: 1.323Kg / Alloy: 6063 / Perimeter: 612mm / Anodizing minimum: 15 microns  
Purity aluminium: 95-98% / Treatment: T-5

# led profile by Luz Negra

led profile professional series for surfaces / hanging applications, manufactured in high purity aluminium and black or white textured coating. The drivers can be housed inside. The profile can be used together with 2 different types of 7 module optics, with 65° or 90° degrees. Also, it has a opaque cover of white or black aluminium for those sections we don't want to illuminate. Thanks to the cover, we lower the UGR and glare effects. The tray can be removed from the front, therefore allowing a maintenance work of the profile. Due to safety reasons, we recommend attaching a twisted wire to the heat dissipating tray from the bottom of the profile. The profile and its cover are available in 3.4 meter lengths.

**We offer a 2 year guarantee on profiles and covers.**



## Aluminium profile

16.012	lacquered white	3.40m
16.013	lacquered black	3.40m



## Aluminium tray

14.033	lacquered white	3.40m
14.034	lacquered black	3.40m



## Reflector with 7 module

46.066	white	28cm
46.067	black	28cm



## Blind cover

18.112	white aluminium	3.40m
18.113	black aluminium	3.40m
18.118	grey aluminium	3,40m



## Optics de with 7 module

46.068	65°	28cm
46.069	90°	28cm



## Aluminium endcaps

19.247	white
19.248	black



## Profile joints

22.044	steel
--------	-------



## Hanging kit

21.001	chrome	set of 2 units
21.002	white	set of 2 units
21.003	black	set of 2 units



## Safety cable

22.039	steel	18cm
--------	-------	------



Aluminium alloy extrusion process in accordance with: ISO 9001:2008 - ISO 14001 / Tolerances defined by: UNE-EN 755-9 / UNE-EN 12020-2  
Theoretical weight: 1.202 Kg. / Alloy: 6063 / Perimeter: 552 / Anodizing minimum: 15 microns  
Purity aluminium: 95-98% / Treatment: T-5

# GALES

with reflector  
and optic

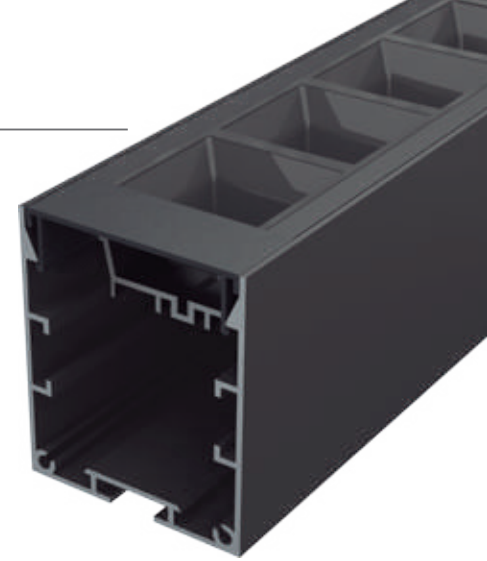

Scale 1:1

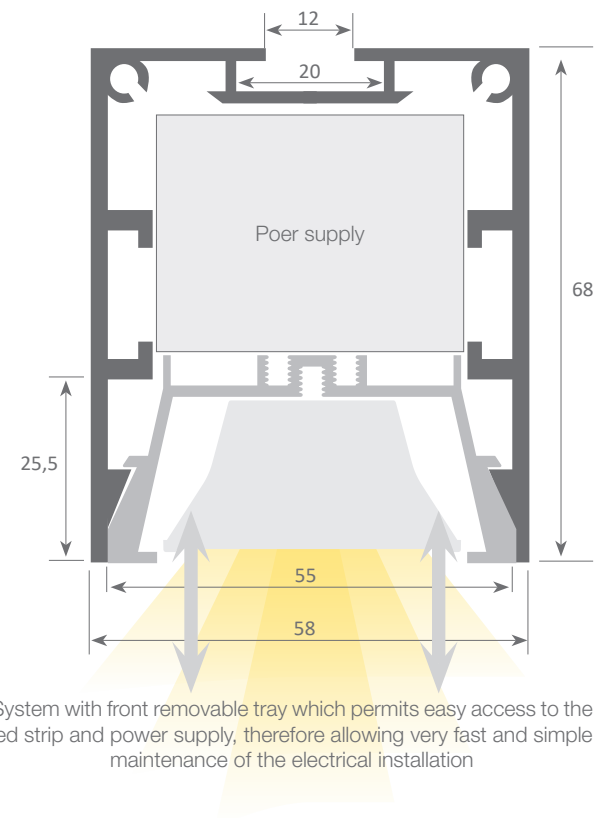





# led profile by Luz Negra

## KAZAN

Our PROFESSIONAL led profile series for hanging applications is manufactured in high purity aluminium with silver anodised, or black/white lacquered textured finishes.

On the upper part we can install a 3-phase track for Up&Down lighting. It is ideal for lighting up decorative elements and products that you want to highlight or to create different environments within a space. Its use is widespread in commercial environments such as showrooms and retail. They are spaces that require a versatile lighting system that adapts to the needs of each situation. In addition, it has an internal tray (in the lower part) where we house the LED and the power supply. This can be removed from the front, meaning easy maintenance and this allows the rigid LED strip to be screwed on one side and the power supply on the other.

For safety measures, we recommend fixing a braided cable from the profile base to the tray.

Both profile and cover are available in 3.4m lengths.

**We offer a 2 year guarantee on the profiles and covers.**

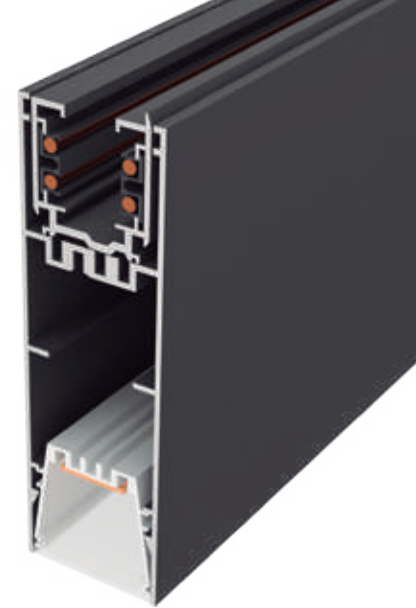

### Aluminium profile

16.033	anodised silver	3.40m
16.034	lacquered black textured	3.40m
16.035	lacquered white textured	3.40m



### Aluminium tray

16.027	lacquered white	3.4m
--------	-----------------	------



### Polycarbonate cover

18.111	frosted	3.40m
--------	---------	-------



### 3-phase rail

16.037	white	2m
16.038	black	2m



### Hanging kit

21.001	chrome	set of 2 units
21.002	white	set of 2 units
21.003	black	set of 2 units



### Aluminium endcaps

19.362	anodised silver
19.363	lacquered black textured
19.364	lacquered white textured



### Hanging kit with screw

21.020	black	set of 2 units
21.021	white	set of 2 units
21.022	chrome	set of 2 units



### Safety cable

22.039	steel	18cm
--------	-------	------

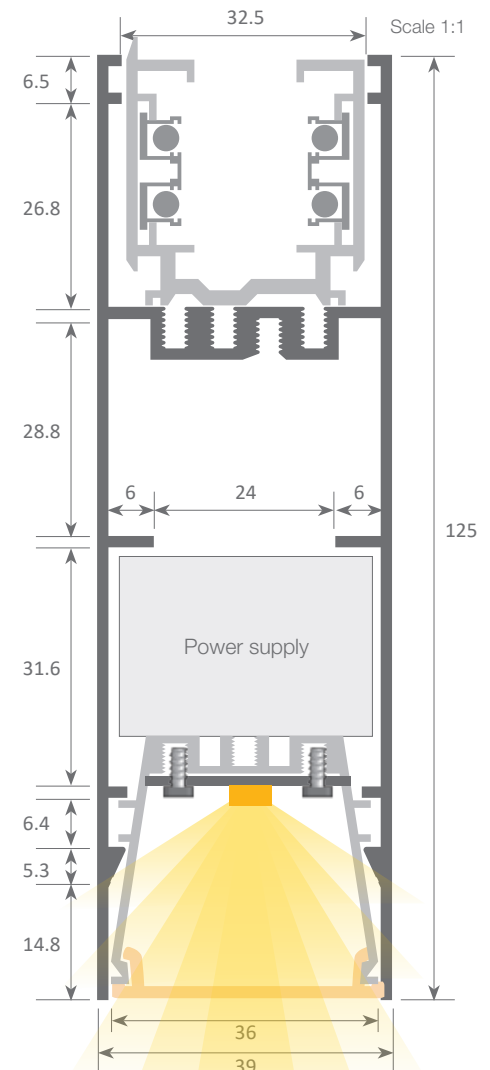

Tolerances: UNE-EN 12020-2 / Theoretical weight: 1.583 kg / Alloy: 6060 / Perimeter: 784,2 mm / Treatment: T-5



**Hanging kit for 3-phase rail**

22.170 white  
22.183 black



**Flexible joining**

22.156 white  
22.157 black



**Straight joining**

22.162 white (right)  
22.163 black (right)



**Connector adapter**

22.168 negro  
22.169 black



**T-shaped derivation**

22.158 white (right)  
22.159 black (right)  
22.160 white (left)  
22.161 black (left)



**Corner**

22.164 white (right)  
22.165 black (right)  
22.166 white (left)  
22.167 black (left)



# led profile by Luz Negra

## LOLA

Our PROFESSIONAL led profile series for surface/hanging applications is manufactured in high purity aluminium, with 8 different colours to choose from. Its inner tray (where we can find the led and power supply) can be removed from the front which means easy maintenance. The tray can also be placed on the upper part of the profile. It has a transparent or frosted microprism cover which improves UGR. Both profile and covers are available in lengths of 6m, allowing us to carry out long installations without joints.

**We offer a 10 year guarantee on the profiles and 4 year guarantee on the covers.**



### Aluminium profile

17.012	azure blue lacquered (ral 5009)	6m
17.013	white lacquered (ral 9003)	6m
17.014	black lacquered (ral 9005)	6m
17.016	patina green lacquered (ral 6000)	6m
17.017	stone grey lacquered (ral 7030)	6m
17.018	pastel yellow lacquered (ral 1034)	6m
17.019	tomato red lacquered (ral 3013)	6m
17.020	ivory lacquered (ral 1014)	6m

### Inner sliding or up tray

17.015	azure blue lacquered (ral 5009)	6m
17.021	patina green lacquered (ral 6000)	6m
17.022	stone grey lacquered (ral 7030)	6m
17.023	pastel yellow lacquered (ral 1034)	6m
17.024	tomato red lacquered (ral 3013)	6m
17.025	ivory lacquered (ral 1014)	6m
17.026	white lacquered (ral 9003)	6m
17.027	black lacquered (ral 9005)	6m



### Polycarbonate cover

18.124	transparent microprism	2m
18.125	frosted microprism	2m
18.122	transparent microprism	6m
18.123	frosted microprism	6m



### Aluminium endcaps

19.374	azure blue lacquered (ral 5009)
19.375	white lacquered (ral 9003)
19.376	black lacquered (ral 9005)
19.377	patina green lacquered (ral 6000)
19.378	stone grey lacquered (ral 7030)
19.379	pastel yellow lacquered (ral 1034)
19.380	tomato red lacquered (ral 3013)
19.381	ivory lacquered (ral 1014)

### Ral colours

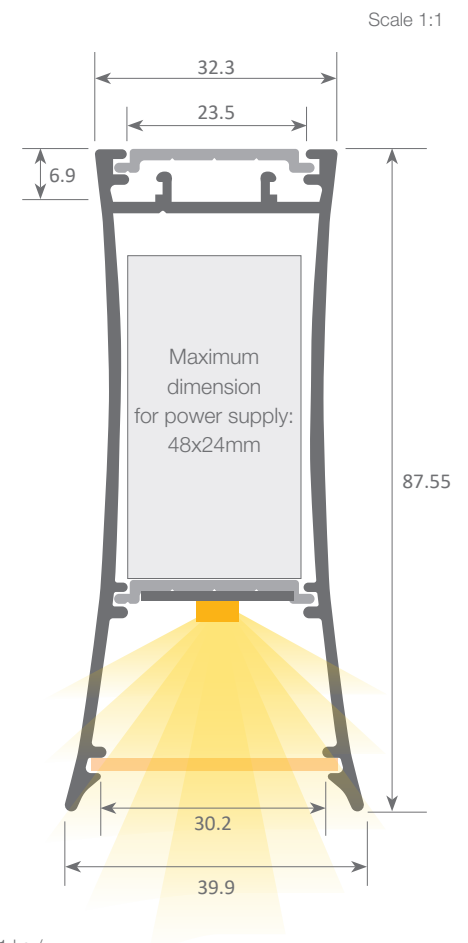

Aluminium alloy extrusion process in accordance with: ISO 9001:2015 / Tolerances: UNE-EN 755-9 / Theoretical weight: 1.091 kg / Alloy: 6063 / Perimeter: 527 mm / Purity aluminium: 98.5% / Treatment: T-5



## Surfaces

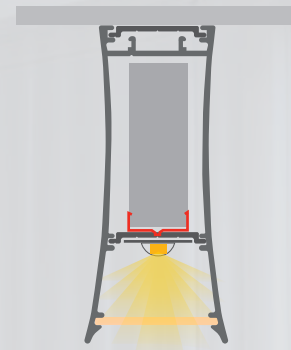

## Hanging

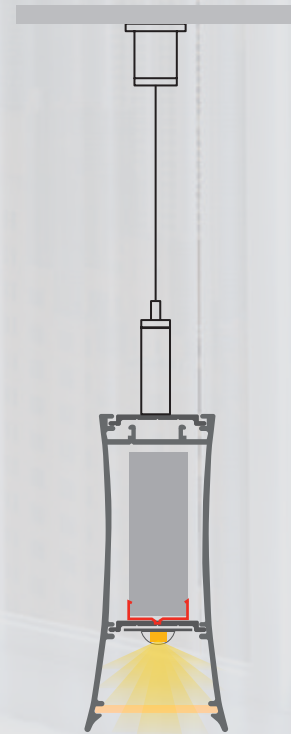

### Clip

20.007 chrome steel  
20.008 black oxide finish



### Hanging kit

21.001 chrome set of 2 units  
21.002 white set of 2 units  
21.003 black set of 2 units



# led profile by Luz Negra

## RICARDO

Our PROFESSIONAL led profile series for surface/hanging applications is manufactured in high purity aluminium, with 8 different colours to choose from. Its inner tray (where we can find the led and power supply) can be removed from the front which means easy maintenance. The tray can also be placed on the upper part of the profile. It has a transparent or frosted microprism cover which improves UGR. Both profile and covers are available in lengths of 6m, allowing us to carry out long installations without joints.

**We offer a 10 year guarantee on the profiles and 4 year guarantee on the covers.**

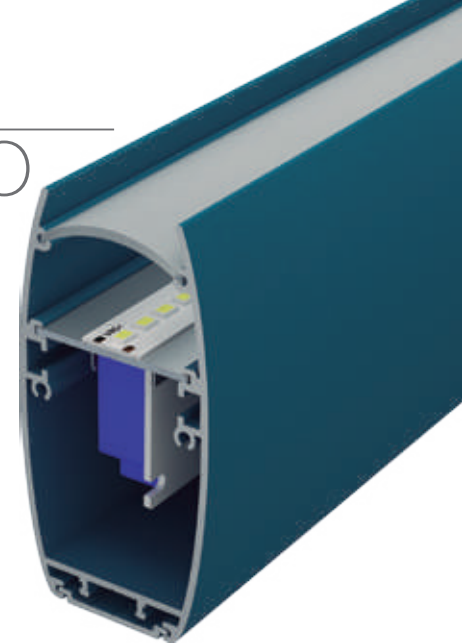
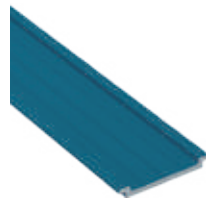
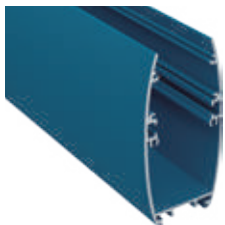

### Aluminium profile

17.052	azure blue lacquered (ral 5009)	6m
17.053	white lacquered (ral 9003)	6m
17.054	black lacquered (ral 9005)	6m
17.055	patina green lacquered (ral 6000))	6m
17.056	stone grey lacquered (ral 7030)	6m
17.057	pastel yellow lacquered (ral 1034)	6m
17.058	tomato red lacquered (ral 3013)	6m
17.059	ivory lacquered (ral 1014)	6m

### Inner sliding or up tray

17.015	azure blue lacquered (ral 5009)	6m
17.021	patina green lacquered (ral 6000)	6m
17.022	stone grey lacquered (ral 7030)	6m
17.023	pastel yellow lacquered (ral 1034)	6m
17.024	tomato red lacquered (ral 3013)	6m
17.025	ivory lacquered (ral 1014)	6m
17.026	white lacquered (ral 9003)	6m
17.027	black lacquered (ral 9005)	6m



### Polycarbonate cover

18.142	transparent microprism	2m
18.144	frosted microprism	2m
18.133	frosted	6m
18.141	transparent microprism	6m
18.143	frosted microprism	6m



### Aluminium endcaps

19.388	azure blue lacquered (ral 5009)
19.389	white lacquered (ral 9003)
19.390	black lacquered (ral 9005)
19.391	patina green lacquered (ral 6000))
19.392	stone grey lacquered (ral 7030)
19.393	pastel yellow lacquered (ral 1034)
19.394	tomato red lacquered (ral 3013)
19.395	ivory lacquered (ral 1014)



### Inner plate

22.191	raw	6m
--------	-----	----

### Ral colours



Scale 1:1

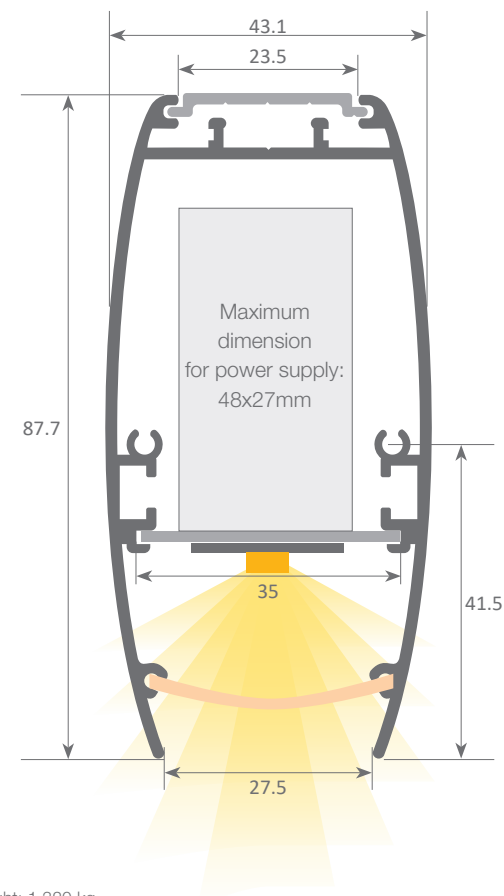

Aluminium alloy extrusion process in accordance with: ISO 9001:2015 / Tolerances: UNE-EN 755-9 / Theoretical weight: 1.320 kg / Alloy: 6063 / Perimeter: 603 mm / Purity aluminium: 98.5% / Treatment: T-5

# led profile by Luz Negra



## Surfaces

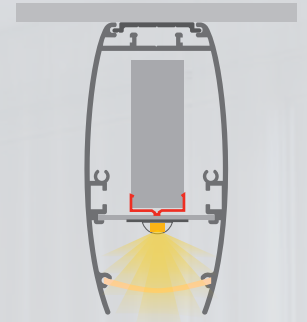

## Hanging

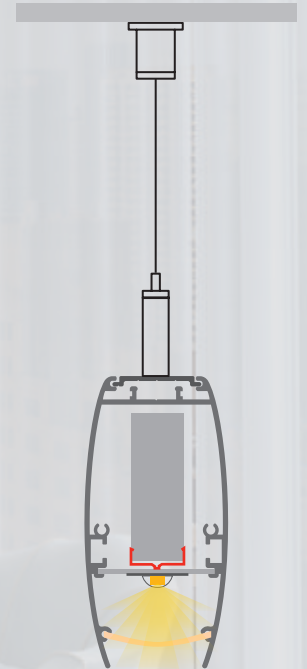

### Joining

22.005 steel



### 120° angle bracket

22.004 steel

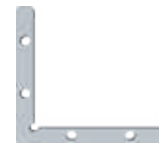

### 90° angle bracket

22.003 steel



### Clip

20.007 chrome steel  
20.008 black oxide finish



### Hanging kit

21.001 chrome set of 2 units  
21.002 white set of 2 units  
21.003 black set of 2 units

# led profile by Luz Negra

## Paco

Our PROFESSIONAL led profile series for surface/hanging applications is manufactured in high purity aluminium, with 8 different colours to choose from.

The profile has an elegant hexagonal shape which can be rotated to achieve the desired lighting effect. Its inner tray (where we can find the led and power supply) can be removed from the front which means easy maintenance.

This profile can be combined with microprism covers both in transparent and frosted ("easy-ON" system), which improve glare and UGR levels. Both profile and covers are available in lengths of 6m, allowing us to carry out long installations without joints.

**We offer a 10 year guarantee on the profiles and 4 year guarantee on the covers.**

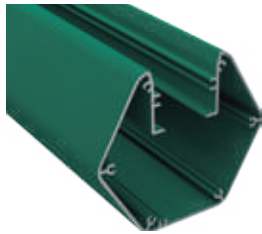
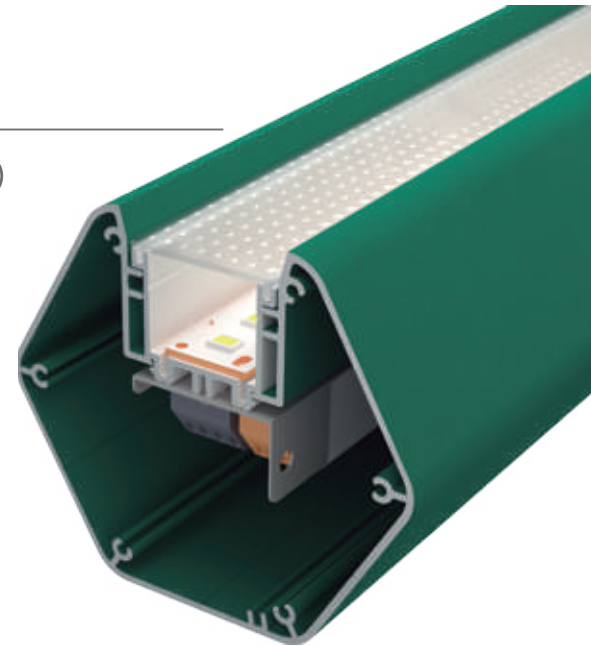

### Aluminium profile

17.036	azure blue lacquered (ral 5009)	6m
17.037	white lacquered (ral 9003)	6m
17.038	black lacquered (ral 9005)	6m
17.039	patina green lacquered (ral 6000))	6m
17.040	stone grey lacquered (ral 7030)	6m
17.041	pastel yellow lacquered (ral 1034)	6m
17.042	tomato red lacquered (ral 3013)	6m
17.043	ivory lacquered (ral 1014)	6m



### Aluminium endcaps

19.404	azure blue lacquered (ral 5009)	
19.405	white lacquered (ral 9003)	
19.406	black lacquered (ral 9005)	
19.407	patina green lacquered (ral 6000))	
19.408	stone grey lacquered (ral 7030)	
19.409	pastel yellow lacquered (ral 1034)	
19.410	tomato red lacquered (ral 3013)	
19.411	ivory lacquered (ral 1014)	



### "easy-ON" polycarbonate cover

18.070	frosted	6m
18.071	transparent microprism	6m
18.072	frosted microprism	6m
18.073	Black&White	6m



### Hanging kit

21.001	chrome	set of 2 units
21.002	white	set of 2 units
21.003	black	set of 2 units



### Aluminium tray

15.007	lacquered white	6m
--------	-----------------	----



### Safety cable

22.039	steel	18cm
--------	-------	------

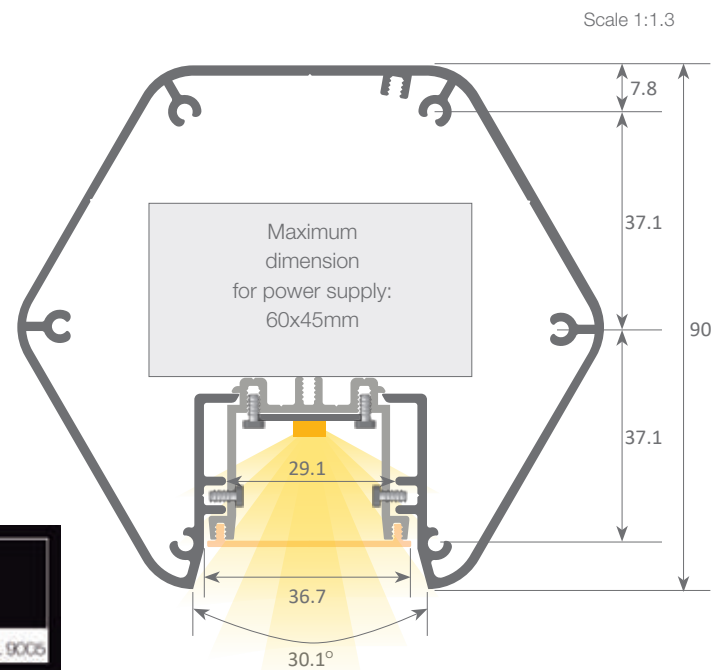

### Ral colours



Aluminium alloy extrusion process in accordance with: ISO 9001:2015 / Tolerances: UNE-EN 755-9 / Theoretical weight: 2.101 kg / Alloy: 6063 / Perimeter: 885 mm / Anodisation minimum: 10 micras / Purity aluminium: 98.5% / Treatment: T-5





Surfaces

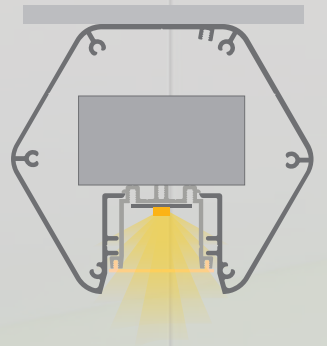

Hanging



Different positions

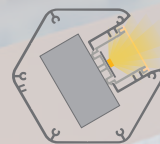

60°

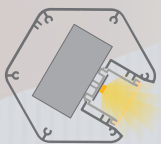

120°

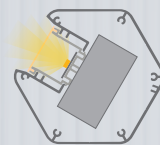

240°

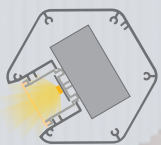

300°

# led profile by Luz Negra

## ANTONIO

Our PROFESSIONAL led profile series for surface/hanging applications is manufactured in high purity aluminium, with 8 different colours to choose from.

Its inner tray (where we can find the led and power supply) can be removed from the front which means easy maintenance.

This profile can be combined with microprism covers both in transparent and frosted ("easy-ON" system), which improve glare and UGR levels. Both profile and covers are available in lengths of 6m, allowing us to carry out long installations without joints.

**We offer a 10 year guarantee on the profiles and 4 year guarantee on the covers.**

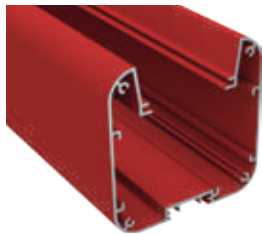
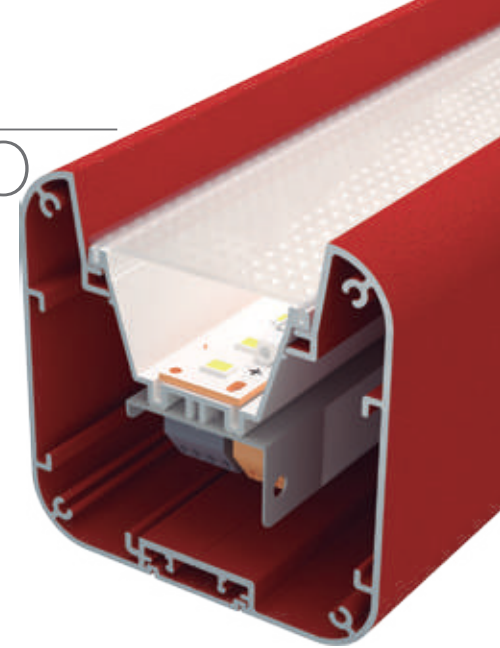

### Aluminium profile

17.028	azure blue lacquered (ral 5009)	6m
17.029	white lacquered (ral 9003)	6m
17.030	black lacquered (ral 9005)	6m
17.031	patina green lacquered (ral 6000)	6m
17.032	stone grey lacquered (ral 7030)	6m
17.033	pastel yellow lacquered (ral 1034)	6m
17.035	tomato red lacquered (ral 3013)	6m
17.035	tivory lacquered (ral 1014)	6m

### Inner sliding or up tray

17.015	azure blue lacquered (ral 5009)	6m
17.021	patina green lacquered (ral 6000)	6m
17.022	stone grey lacquered (ral 7030)	6m
17.023	pastel yellow lacquered (ral 1034)	6m
17.024	tomato red lacquered (ral 3013)	6m
17.025	tivory lacquered (ral 1014)	6m
17.026	white lacquered (ral 9003)	6m
17.027	black lacquered (ral 9005)	6m



### Aluminium tray

14.007	lacquered white	6m
14.042	lacquered black	6m



Space to house joint plates or 90° inner brackets.

### Aluminium endcaps

19.412	azure blue lacquered (ral 5009)
19.413	white lacquered (ral 9003)
19.414	black lacquered (ral 9005)
19.415	patina green lacquered (ral 6000)
19.416	stone grey lacquered (ral 7030)
19.417	pastel yellow lacquered (ral 1034)
19.418	tomato red lacquered (ral 3013)
19.419	tivory lacquered (ral 1014)

### "easy-ON" polycarbonate cover

18.074	frosted	6m
18.075	transparent microprism	6m
18.076	frosted microprism	6m

### Ral colours



Aluminium alloy extrusion process in accordance with: ISO 9001:2015 / Tolerances: UNE-EN 755-9 / Theoretical weight: 2.303 kg / Alloy: 6063 / Perimeter: 967 mm / Anodisation minimum: 10 micras / Purity aluminium: 98.5% / Treatment: T-5

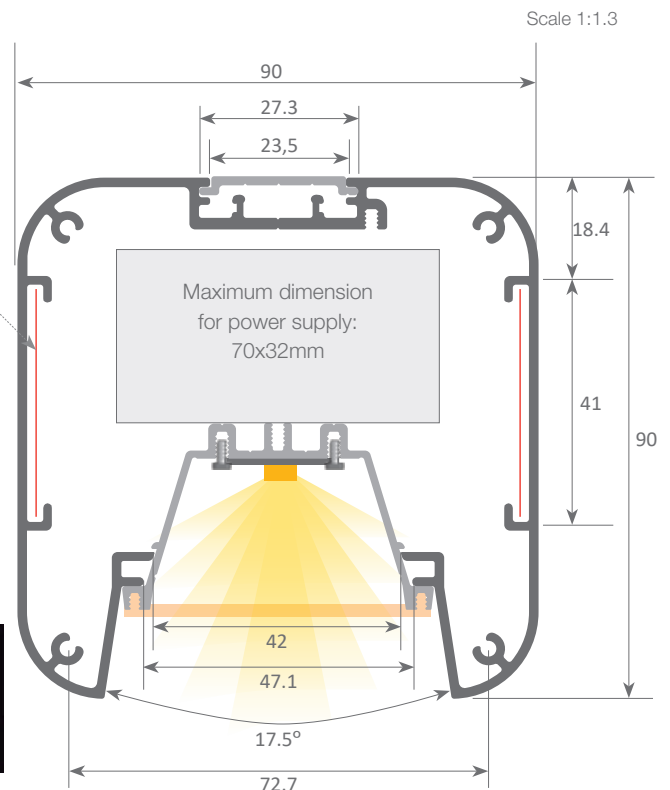



Surfaces

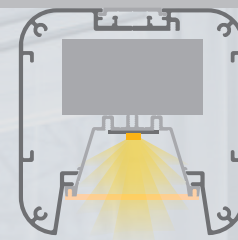

Hanging

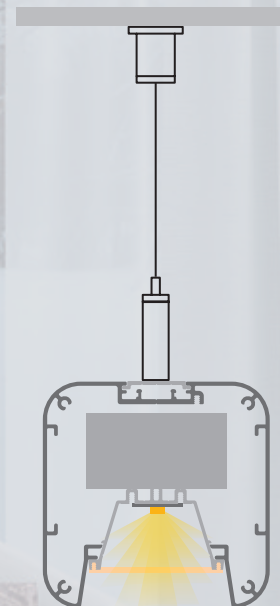

**90° angle bracket**  
22.040 aluminium set of 2 units



**Flat bracket**  
22.057 aluminium set of 2 units



**Joining plate**  
22.041 aluminium set of 2 units



**Clip**  
20.007 chrome steel  
20.008 black oxide finish



**Hanging kit**  
21.001 chrome set of 2 units  
21.002 white set of 2 units  
21.003 black set of 2 units



**Safety cable**  
22.039 steel 18cm

# led profile by Luz Negra

## Carmen

Our PROFESSIONAL led profile series for surface/hanging applications is manufactured in high purity aluminium, with 8 different colours to choose from.

Its inner tray (where we can find the led and power supply) can be removed from the front which means easy maintenance.

This profile can be combined with microprism covers both in transparent and frosted ("easy-ON" system), which improve glare and UGR levels. Both profile and covers are available in lengths of 6m, allowing us to carry out long installations without joints.

**We offer a 10 year guarantee on the profiles and 4 year guarantee on the covers.**

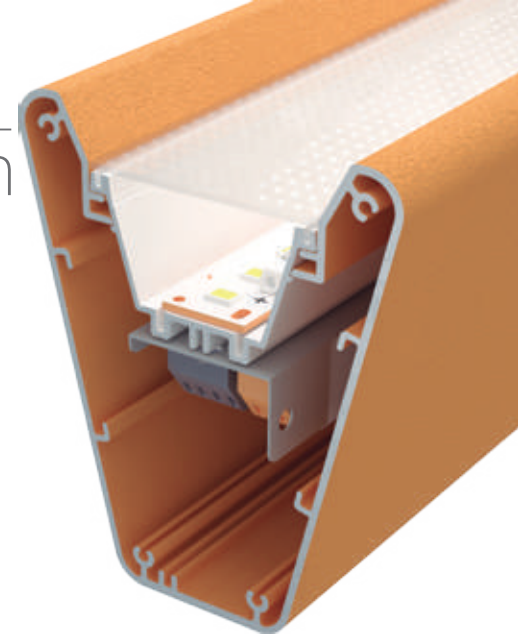
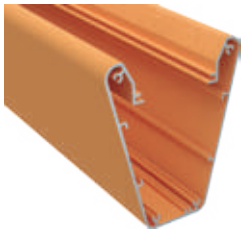

### Aluminium profile

17.044	azure blue lacquered (ral 5009)	6m
17.045	white lacquered (ral 9003)	6m
17.046	black lacquered (ral 9005)	6m
17.047	patina green lacquered (ral 6000)	6m
17.048	stone grey lacquered (ral 7030)	6m
17.049	pastel yellow lacquered (ral 1034)	6m
17.050	tomato red lacquered (ral 3013)	6m
17.051	tivory lacquered (ral 1014)	6m

### Bandeja deslizante

19.396	azure blue lacquered (ral 5009)	6m
19.399	patina green lacquered (ral 6000)	6m
19.398	black lacquered (ral 9005)	6m
19.397	white lacquered (ral 9003)	6m
19.400	stone grey lacquered (ral 7030)	6m
19.401	pastel yellow lacquered (ral 1034)	6m
19.402	tomato red lacquered (ral 3013)	6m
19.403	tivory lacquered (ral 1014)	6m



### "easy-ON" polycarbonate cover

18.074	frosted	6m
18.075	transparent microprism	6m
18.076	frosted microprism	6m



### Hanging kit

21.001	chrome	set of 2 units
21.002	white	set of 2 units
21.003	black	set of 2 units



### Aluminium tray

14.007	lacquered white	6m
14.042	lacquered black	6m



### Safety cable

22.039	steel	18cm
--------	-------	------

### Ral colours

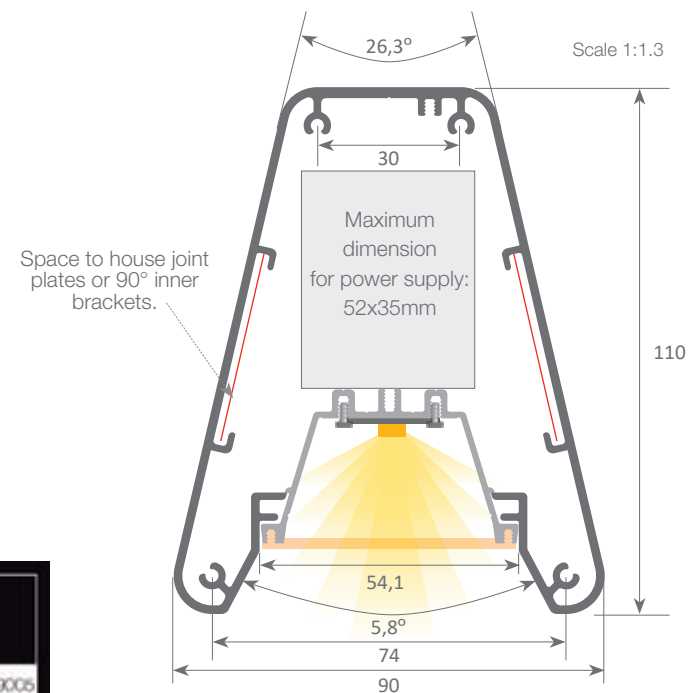

Aluminium alloy extrusion process in accordance with: ISO 9001:2015 / Tolerances: UNE-EN 755-9 / Theoretical weight: 2.249 kg / Alloy: 6063 / Perimeter: 935 mm / Anodisation minimum: 10 micras / Purity aluminium: 98.5% / Treatment: T-5



Surfaces

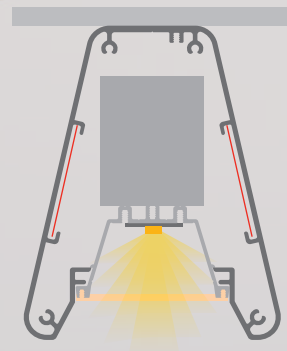

Hanging

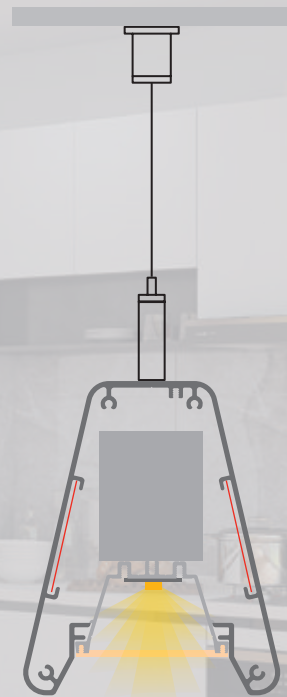

**90° angle bracket**  
22.040 aluminium

set of 2 units



**Flat bracket**  
22.057 aluminium

set of 2 units



**Joining plate**  
22.041 aluminium

set of 2 units

big profiles for recessing





MOSCU  
MINI

214

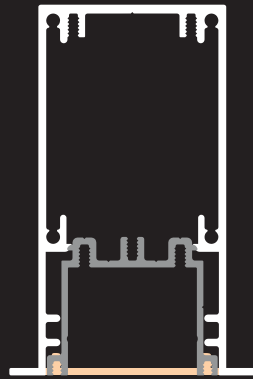

MOSCU  
MAGNUM  
SLIM

216

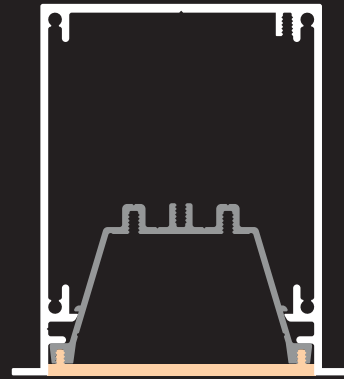

MOSCU  
MAGNUM

218

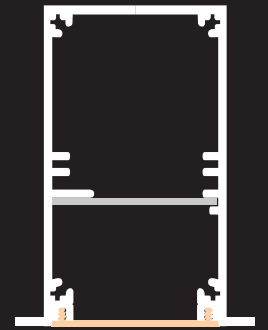

MOSCU  
SLIM

220

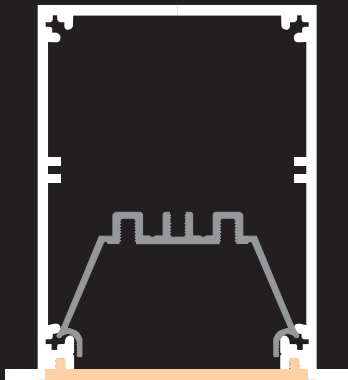

MOSCU

221

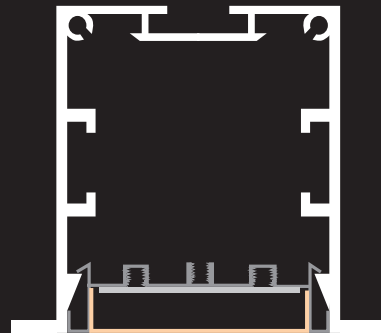

KRAKOVIA  
with OPTIC

222

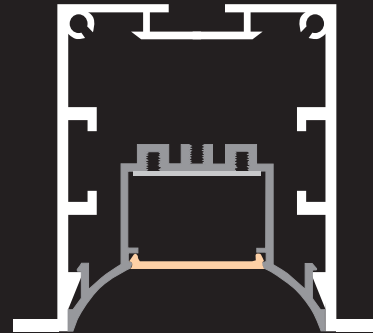

KRAKOVIA  
with RECESSED  
TRAY

223

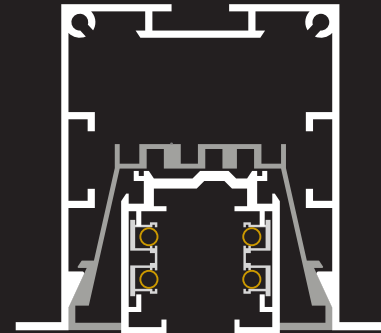

KRAKOVIA  
with 3-phase rail

224

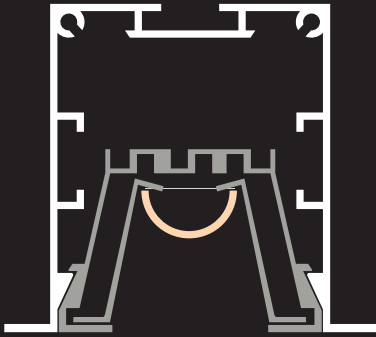

KRAKOVIA  
with tray and  
trellis

226



KRAKOVIA  
ASYMMETRIC

226

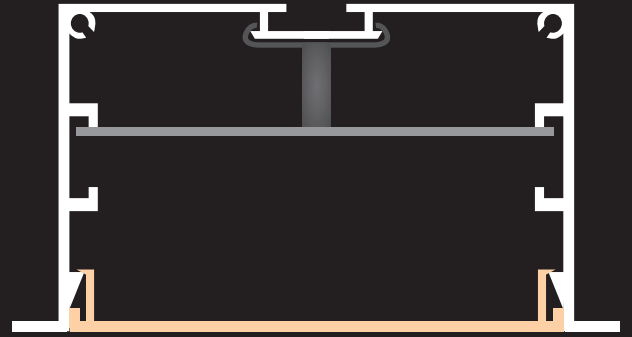

ANDORRA

227

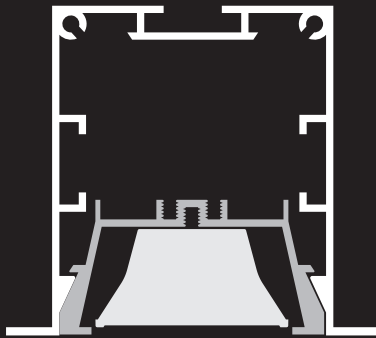

KRAKOVIA  
with reflector  
and optic

227A

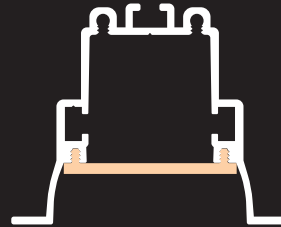

KIEV

227B



SIDNEY

227D



# led profile by Luz Negra

Our PROFESIONAL led profile series for embedding is manufactured in high purity silver anodised and black or white lacquered textured aluminium. Its cover ("easy-ON" system) in frosted white finishing, which offers an IP65 to the luminaire, is extremely useful in areas with high humidity levels.

Covers are also available in frosted or transparent microprism, which improve glare and also higher UGR levels. Both profile and cover are available in 6m length, allowing us to carry out long projects without joints.

**We offer a 10 year guarantee on the profile and a 4 year guarantee on the covers.**

Scale 1:1

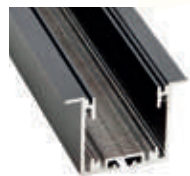
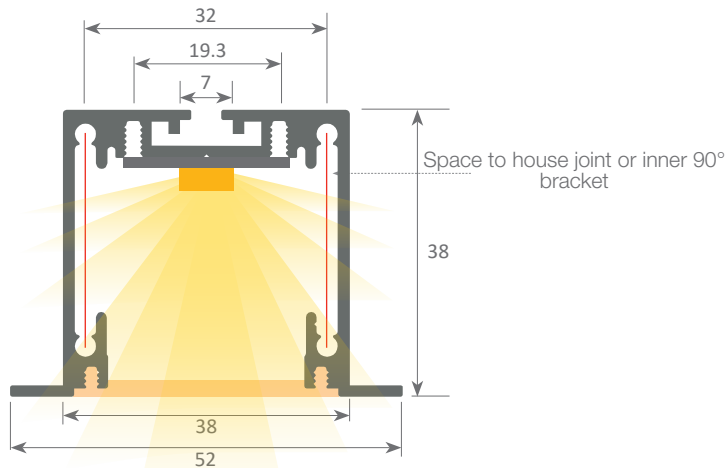

## Aluminium profile

14.001	silver anodised	6m
14.002	lacquered white	6m
14.003	lacquered black	6m



## Aluminium endcaps

19.186	silver anodised
19.187	lacquered white
19.188	lacquered black



## Fixing bracket

20.023 for shallow recessing profiles



## "easy-ON" polycarbonate cover

18.070	"easy-ON" frosted	6m
18.071	transparent microprism	6m
18.072	frosted microprism	6m
18.073	Black&White	6m



## Fixing bracket

20.042 steel

# MOSCU MINI



IP65



Patente Europea  
Nº.: 13156605.1

Aluminium alloy extrusion process in accordance with: ISO 9001:2008 - ISO 14001 / Tolerances defined by: UNE-EN 755-9 / UNE-EN 12020-2  
Theoretical weight: 0,862Kg / Alloy: 6063 / Perimeter: 380mm / Anodising minimum: 15 microns  
Purity aluminium: 95-98% / Treatment: T-5 / Covers: Fireproof V0



**90° angle bracket**  
Ref: 22.035

**Joining plate**  
Ref: 22.034

**Flat bracket**  
Ref: 22.058



**90° angle bracket**  
22.035 aluminium set of 2 units



**Joining plate**  
22.034 aluminium set of 2 units



**Flat bracket**  
22.058 aluminium set of 2 units



Patente Europea  
Nº.: 13156605.1

# led profile by Luz Negra

Our PROFESIONAL led profile series for embedding is manufactured in high purity silver anodised and black or white lacquered textured aluminium. Its internal tray, where the led and the power supply are placed, can be removed from the front which means easy maintenance. Drivers can be housed inside. Its "easy-ON" system cover in frosted white finishing, which offers an IP65 to the luminaire, is extremely useful in areas with high humidity levels.

Covers are also available in frosted or transparent microprism, which improves glare and also UGR levels. Both profile and cover are available in 6m lengths, allowing us to carry out long projects without joints.

**We offer a 10 year guarantee on the profile and a 4 year guarantee on the covers.**

## MOSCU MAGNUM SLIM



IP65



### Aluminium profile

15.004	anodised silver	6m
15.005	lacquered white	6m
15.006	lacquered black	6m



### Aluminium tray

15.007	lacquered white	6m
--------	-----------------	----



### "easy-ON" polycarbonate cover

18.070	frosted	6m
18.071	transparent microprism	6m
18.072	frosted microprism	6m
18.073	Black&White	6m



### 90° angle bracket

22.040	aluminium	set of 2 units
--------	-----------	----------------



### Aluminium endcaps

19.195	anodised silver
19.196	lacquered white
19.197	lacquered black



### Flat bracket

22.057	aluminium	set of 2 units
--------	-----------	----------------



### Joining plate

22.041	aluminium	set of 2 units
--------	-----------	----------------



### Safety cable

22.039	steel	18 cm
--------	-------	-------



### Fixing bracket

20.045	steel
--------	-------

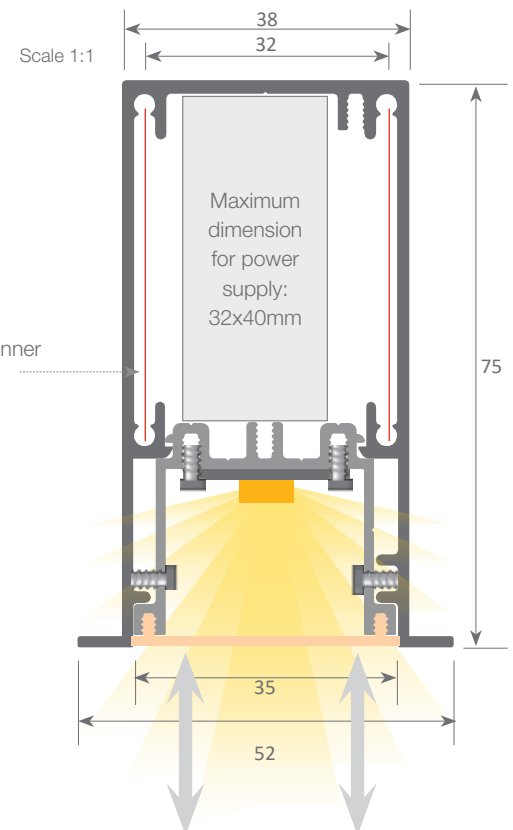

System with front removable tray which permits easy access to the led strip and power supply, therefore allowing very fast and simple maintenance of the electrical installation.



Patente Europea  
Nº.: 13156605.1

Aluminium alloy extrusion process in accordance with: ISO 9001:2008 - ISO 14001 / Tolerances defined by: UNE-EN 755-9 / UNE-EN 12020-2  
Theoretical weight: 1.464Kg / Alloy: 6063 / Perimeter: 483mm / Anodising minimum: 15 microns  
Purity aluminium: 95-98% / Treatment: T-5 / Covers: Fireproof V0

**90° angle bracket**  
22.040



**Flat bracket**  
22.057



# led profile by Luz Negra

Our PROFESIONAL led profile series for embedding is manufactured in high purity silver anodised and black or white lacquered textured aluminium. Its internal tray, where the led and the power supply are placed, can be removed from the front which means easy maintenance. Drivers can be housed inside. Its "easy-ON" system cover in frosted white finishing, which offers an IP65 to the luminaire, is extremely useful in areas with high humidity levels.

Covers are also available in frosted or transparent microprism, which improves glare and also UGR levels. Both profile and cover are available in 6m lengths, allowing us to carry out long projects without joints.

**We offer a 10 year guarantee on the profile and a 4 year guarantee on the covers.**

## MOSCU MAGNUM



IP65



### Aluminium profile

14.004	anodised silver	6 m
14.005	lacquered black	6 m
14.006	lacquered white	6 m



### Aluminium tray

14.007	lacquered white	6 m
14.042	lacquered black	6 m



### "easy-ON" polycarbonate cover

18.074	frosted	6 m
18.075	transparent microprism	6 m
18.076	frosted microprism	6 m



### Aluminium endcaps

19.192	silver anodised
19.193	lacquered white
19.194	lacquered black



### Reflector with 4 module optics

46.046	white 50° optic
46.047	black 50° optic
46.048	white 80° optic
46.049	black 80° optic



### Safety cable

22.039	steel	18 cm
--------	-------	-------



### Fixing bracket

20.044	steel
--------	-------

### Reflector with 7 module optics

46.050	white 50° optic
46.051	black 50° optic
46.052	white 80° optic
46.053	black 80° optic

Scale 1:1

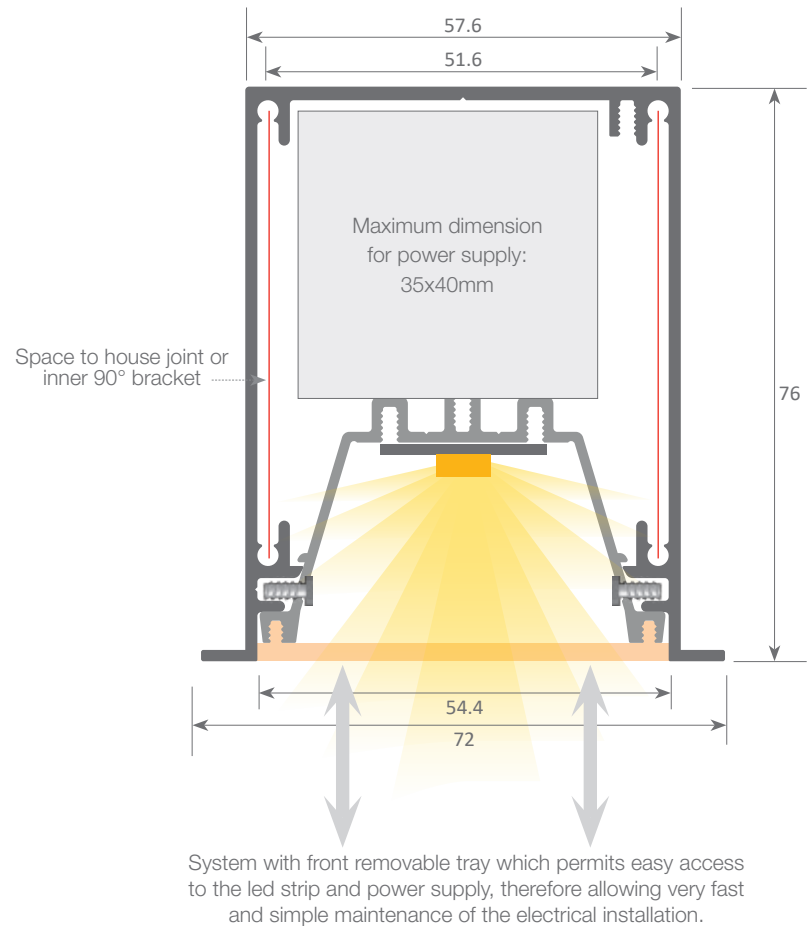

Patente Europea  
Nº.: 13156605.1

Aluminium alloy extrusion process in accordance with: ISO 9001:2008 - ISO 14001 / Tolerances defined by: UNE-EN 755-9 / UNE-EN 12020-2  
Theoretical weight: 1.666Kg / Alloy: 6063 / Perimeter: 535mm / Anodising minimum: 15 microns  
Purity aluminium: 95-98% / Treatment: T-5 / Covers: Fireproof V0



**90° angle bracket**  
22.037



**Flat bracket**  
22.059



**Flat bracket**  
22.059 aluminium

set of 2 units



**90° angle bracket**  
22.037 aluminium

set of 2 pieces



**Joining plate**  
22.038 aluminium

set of 2 pieces

# led profile by Luz Negra

Our PROFESIONAL led profile series for embedding is manufactured in high purity silver anodised and black or white lacquered textured aluminium. Drivers can be housed inside.

This profile can be combined with our "easy-ON" frosted white cover, which offers an IP65 to the luminaire. This is extremely useful in areas with high humidity levels. We also have available transparent and frosted microprism covers which improve glare and UGR levels.

Both profile and cover are available in 6m length allowing us to carry out long projects without joints.

**We offer a 10 year guarantee on the profiles and a 4 year guarantee on the covers.**

## MOSCU SLIM



IP65

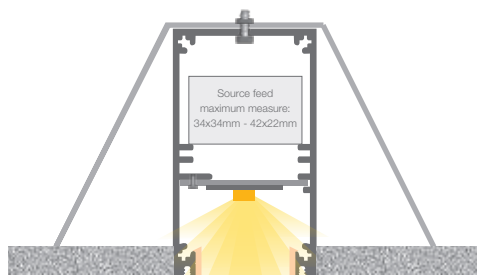
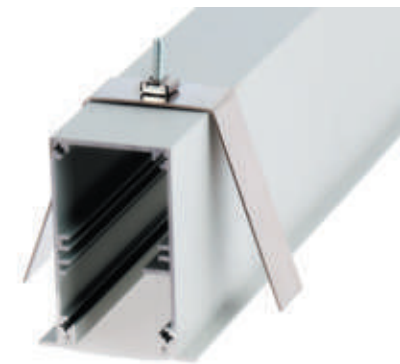

Microprism cover

18.071 transparent - 18.072 frosted

Scale 1:1

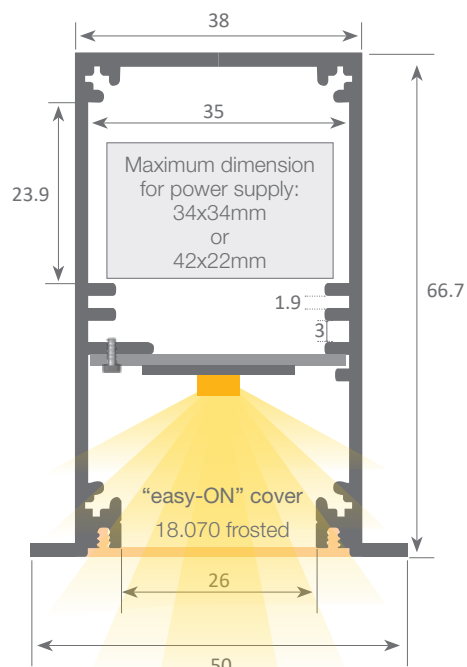

### Aluminium profile

15.001	silver anodised	6m
15.002	lacquered white	6m
15.003	lacquered black	6m



### "easy-ON" polycarbonate cover

18.070	frosted	6m
18.071	transparent microprism	6m
18.072	frosted microprism	6m
18.073	Black&White	6m



### Aluminium endcaps

19.189	silver anodised
19.190	lacquered white
19.191	lacquered black



### Fixing bracket

20.043 steel



### Inner plate

22.036 aluminium 200 cm



Patente Europea  
Nº.: 13156605.1

Aluminium alloy extrusion process in accordance with: ISO 9001:2008 - ISO 14001 / Tolerances defined by: UNE-EN 755-9 / UNE-EN 12020-2  
Theoretical weight: 1,048Kg / Alloy: 6063 / Perimeter: 483mm / Anodising minimum: 15 microns  
Purity aluminium: 95-98% / Treatment: T-5 / Covers: Fireproof V0

# led profile by Luz Negra

Our PROFESSIONAL led profile series for recessing is manufactured in high purity silver anodised and black or white lacquered textured aluminium. Drivers can be housed inside.

This profile can be combined with our "easy-ON" frosted white cover, which offers an IP65 to the luminaire, and it is extremely useful in areas with high humidity levels. We also have available transparent and frosted microprism covers which improve glare and UGR levels.

Both profile and cover are available in 6 metre lengths which permit long installations to be carried out without requiring joints.

**We offer a 10 year guarantee on the profiles and a 4 year guarantee on the covers.**

## MOSCU



IP65



### Aluminium profile

14.008	anodised silver	6m
14.009	lacquered white	6m
14.010	lacquered black	6m



### Fixing bracket

20.046	steel
Measurements: 60x75mm	



### "easy-ON" polycarbonate cover

18.074	frosted	6m
18.075	transparent microprism	6m
18.076	frosted microprism	6m



### Inner plate

22.190	aluminium	200 cm
--------	-----------	--------



### Aluminium endcaps

19.198	silver anodised
19.199	lacquered white
19.200	lacquered black

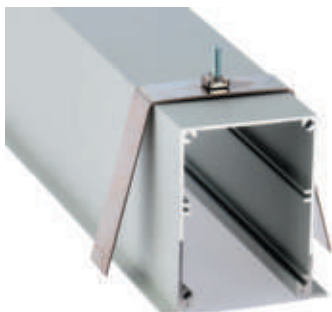

Scale 1:1

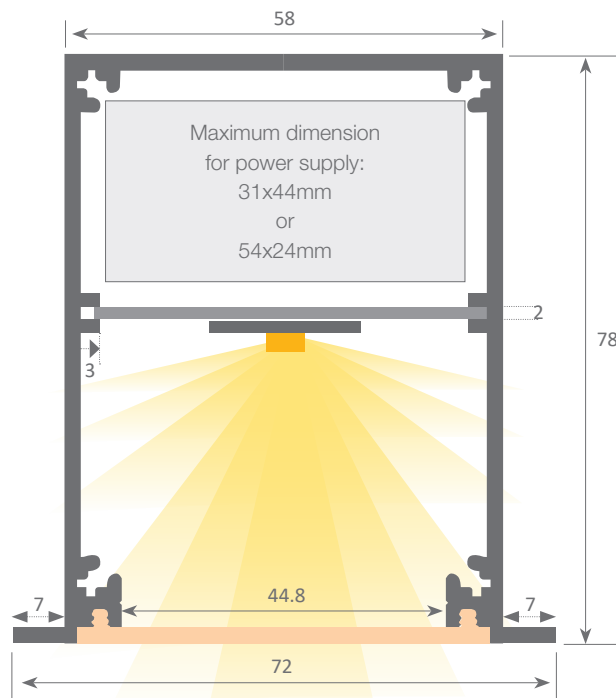

Patente Europea  
Nº.: 13156605.1

Aluminium alloy extrusion process in accordance with: ISO 9001:2008 - ISO 14001 / Tolerances: UNE-EN 755-9 / UNE-EN 12020-2  
Theoretical weight: 1.239Kg / Alloy: 6063 / Perimeter: 544mm / Anodising minimum: 15 microns  
Purity aluminium: 95-98% / Treatment: T-5 / Covers: Fireproof V0



# led profile by Luz Negra

Our PROFESSIONAL led profile series for recessing applications is manufactured in high purity aluminium and lacquered in textured white, black and grey. Drivers can be housed inside. This profile can be used with different types of optics (see page 307).

The internal tray allows us to screw the rigid led strip on one side and enables us to house the power supply on the other. At the same time this tray can be removed from the front which means easy maintenance. For safety measures, we recommend the fixing of a braided cable from the profile base to the dissipation tray. Both profile and cover are available in 3.4 metre lengths.

**We offer a 2 year guarantee on the profiles and covers.**

## KRAKOVIA with OPTIC

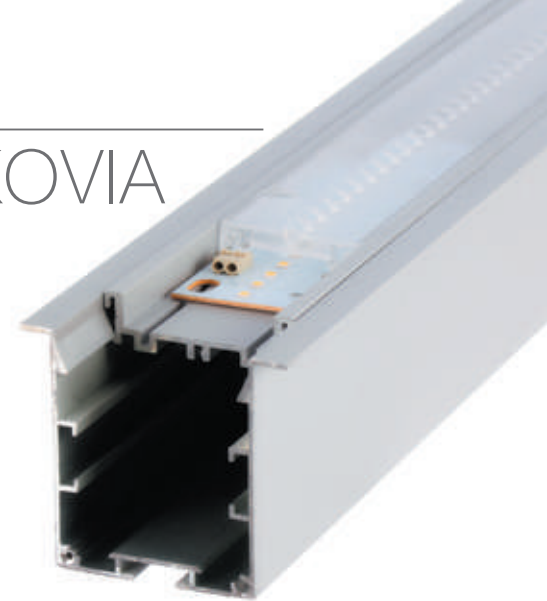

Scale 1:1



### Aluminium profile

14.011	textured grey	3.40m
14.012	textured white	3.40m
14.013	textured black	3.40m



### Internal tray

14.014	textured grey	3.40m
14.015	textured white	3.40m
14.026	textured black	3.40m



### Optic

See page 307



### Joint between profiles

22.044 steel set of 2 units



### Aluminium endcaps

19.201	grey
19.202	white
19.203	black



### Fixing bracket

20.047 steel



### Safety cable

22.039 steel 18cm

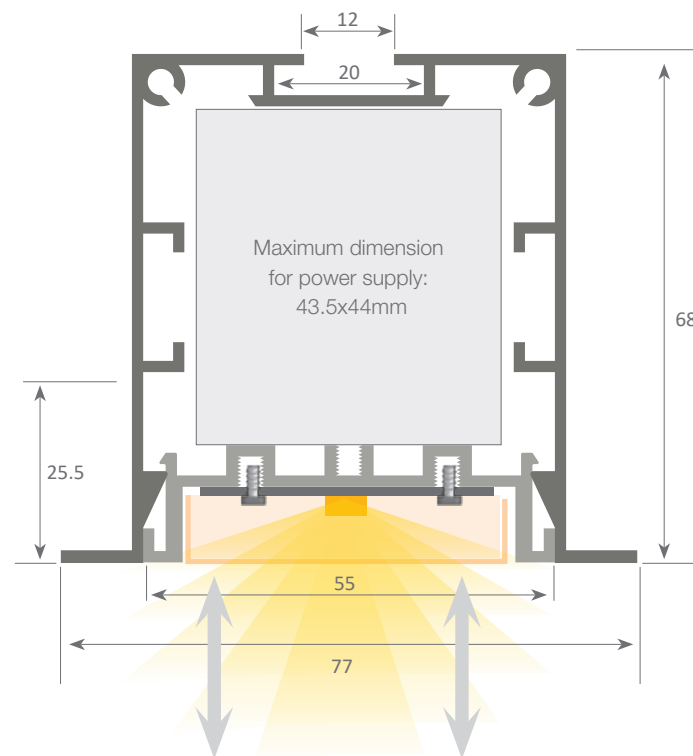

System with front removable tray which permits easy access to the led strip and power supply, therefore allowing very fast and simple maintenance of the electrical installation.



Aluminium alloy extrusion process in accordance with: ISO 9001:2008 - ISO 14001 / Tolerances: UNE-EN 755-9 / UNE-EN 12020-2  
Theoretical weight: 1.202Kg / Alloy: 6063 / Perimeter: 562mm / Anodising minimum: 15 microns  
Purity aluminium: 95-98% / Treatment: T-5

# led profile by Luz Negra

Our PROFESSIONAL led profile series for recessing applications is manufactured in high purity aluminium and lacquered in textured white, black and grey. Drivers can be housed inside. The internal tray allows us to screw the rigid led strip on one side and enables us to house the power supply on the other. At the same time this tray can be removed from the front which means easy maintenance. For safety measures, we recommend the fixing of a braided cable from the profile base to the dissipation tray. Both profile and cover are available in 3.4 metre lengths.

**We offer a 2 year guarantee on the profiles and covers.**

## KRAKOVIA with RECESSED TRAY

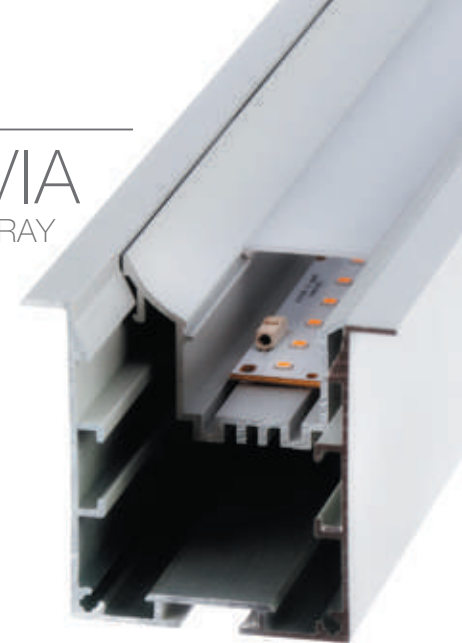

### Aluminium profile

14.011	textured grey	3.40m
14.012	textured white	3.40m
14.013	textured black	3.40m



### Recessed tray

14.018	textured grey	3.40m
14.019	textured white	3.40m
14.025	textured black	3.40m



### Polycarbonate cover

18.079	frosted	3.40m
--------	---------	-------



### Joint between profiles

22.044	steel	set of 2 units
--------	-------	----------------



### Aluminium endcaps

19.201	grey
19.202	white
19.203	black



### Fixing bracket

20.047	steel
--------	-------



### Safety cable

22.039	steel	18cm
--------	-------	------

Scale 1:1

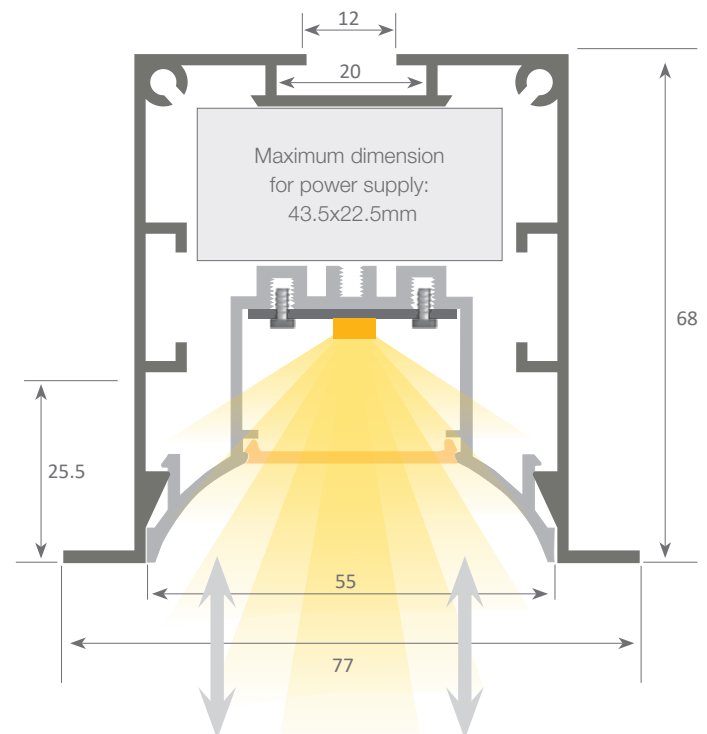

System with front removable tray which permits easy access to the led strip and power supply, therefore allowing very fast and simple maintenance of the electrical installation.



Aluminium alloy extrusion process in accordance with: ISO 9001:2008 - ISO 14001 / Tolerances: UNE-EN 755-9 / UNE-EN 12020-2  
Theoretical weight: 1.202Kg / Alloy: 6063 / Perimeter: 562mm / Anodising minimum: 15 microns  
Purity aluminium: 95-98% / Treatment: T-5

# led profile by Luz Negra

Our PROFESSIONAL led profile series for recessing applications is manufactured in high purity aluminium and lacquered in white or textured black. Drivers can be housed inside. The tray can be removed from the front which means easy maintenance. Also, this tray can be combined also with a "Global" 3 phase rail in order to hang spotlights. For safety we recommend fising a braided cable from the profile base to the tray. Both profile and cover are available in 3.4m lengths. **We offer a 2 year guarantee on the profiles and covers.**

## KRAKOVIA

with tray and "Global"  
3-phase rail

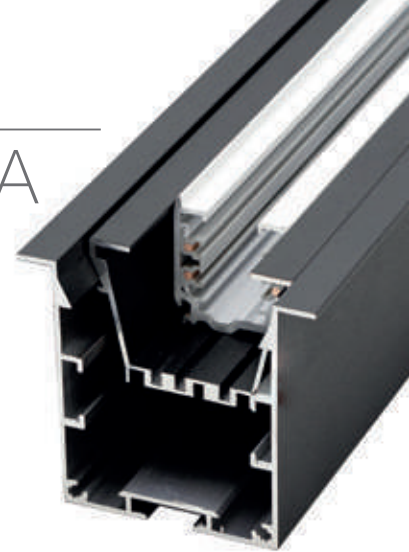

### Aluminium profile

14.012 textured white 3.40m  
14.013 textured black 3.40m



### Aluminium tray

14.016 textured white 3.40m  
14.017 textured black 3.40m



### Trellis

16.037 textured white 3m  
16.038 textured black 3m



### Joint between profiles

22.044 steel set of 2 units



### Aluminium endcaps

19.202 white  
19.203 black



### Fixing bracket

20.047 steel



### Safety cable

22.039 steel 18 cm

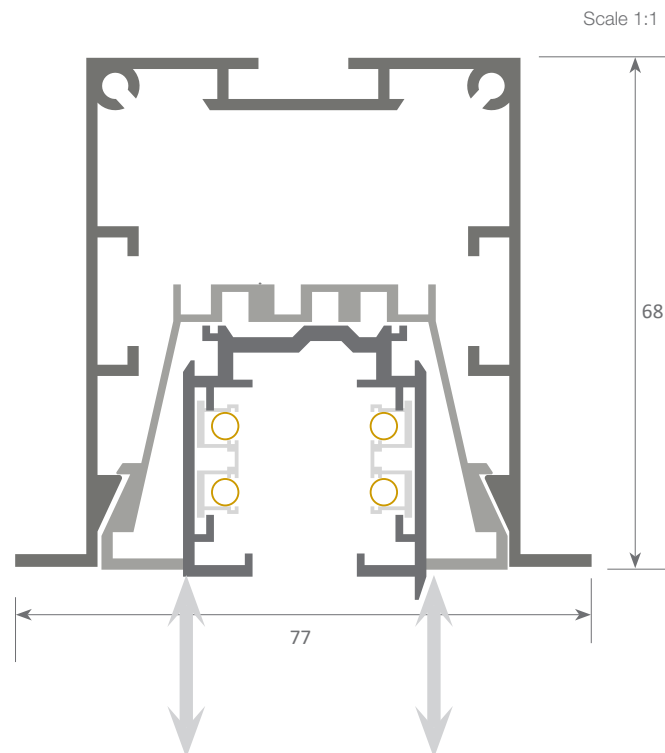

System with front removable tray which permits easy access to the led strip and power supply, therefore allowing very fast and simple maintenance of the electrical installation.



Aluminium alloy extrusion process in accordance with: ISO 9001:2008 - ISO 14001 / Tolerances: UNE-EN 755-9 / UNE-EN 12020-2  
Theoretical weight: 1.202Kg / Alloy: 6060 / Perimeter: 552mm / Anodising minimum: 15 microns  
Purity aluminium: 95-98% / Treatment: T-5

# led profile by Luz Negra

Our PROFESSIONAL led profile series for recessing applications is manufactured in high purity aluminium and lacquered in white or textured black. Drivers can be housed inside. The internal tray allows us to screw the rigid led strip on one side and enables us to house the power supply on the other. At the same time this tray can be removed from the front which means easy maintenance. For safety we recommend fixing a braided cable from the profile base to the tray. Both profile and cover are available in 3.4m lengths.

**We offer a 2 year guarantee on the profiles and covers.**

## KRAKOVIA

with tray and trellis

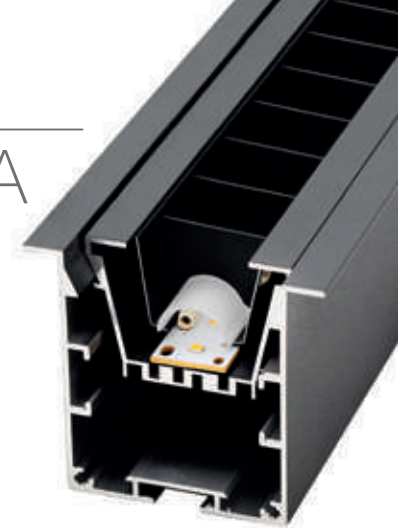

### Aluminium profile

14.012 textured white 3.40m  
14.013 textured black 3.40m



### Aluminium tray

14.016 textured white 3.40m  
14.017 textured black 3.40m



### Trellis

16.016 textured white 1.124m  
16.017 textured black 1.124m



### Joint between profiles

22.044 steel set of 2 units



### Aluminium endcaps

19.202 white  
19.203 black



### Fixing bracket

20.047 steel



### Safety cable

22.039 steel 18cm

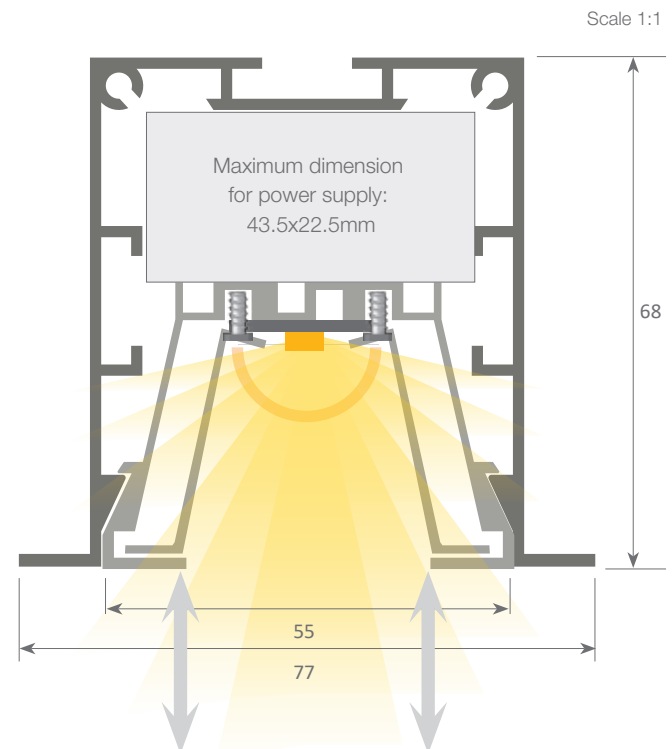

System with front removable tray which permits easy access to the led strip and power supply, therefore allowing very fast and simple maintenance of the electrical installation.



Aluminium alloy extrusion process in accordance with: ISO 9001:2008 - ISO 14001 / Tolerances: UNE-EN 755-9 / UNE-EN 12020-2  
Theoretical weight: 1.202Kg / Alloy: 6060 / Perimeter: 552mm / Anodising minimum: 15 microns  
Purity aluminium: 95-98% / Treatment: T-5

# led profile by Luz Negra

Our PROFESSIONAL led profile series for recessing applications is manufactured in high purity aluminium and lacquered in textured white, black and grey. Drivers can be housed inside. The internal tray allows us to screw the 20mm rigid led strip on one side and enables us to house the power supply on the other. At the same time this tray can be removed from the front which means easy maintenance. For safety we recommend the fixing of a braided cable from the profile base to the dissipation tray. Both profile and cover are available in 3.4 metre lengths.

**We offer a 2 year guarantee on the profiles and covers.**

## KRAKOVIA ASYMMETRIC

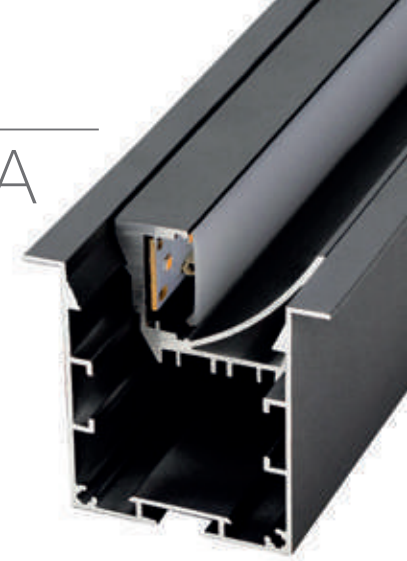

### Aluminium profile

14.011	textured grey	3.40m
14.012	textured white	3.40m
14.013	textured black	3.40m



### Aluminium tray

14.022	textured white	3.40m
14.023	textured black	3.40m
14.024	textured grey	3.40m



### Polycarbonate cover

18.079	frosted	3.40m
--------	---------	-------



### Joint between profiles

22.044	steel	set of 2 units
--------	-------	----------------



### Aluminium endcaps

19.201	grey
19.202	white
19.203	black



### Fixing bracket

20.047	steel
--------	-------



### Safety cable

22.039	steel	18cm
--------	-------	------

Scale 1:1

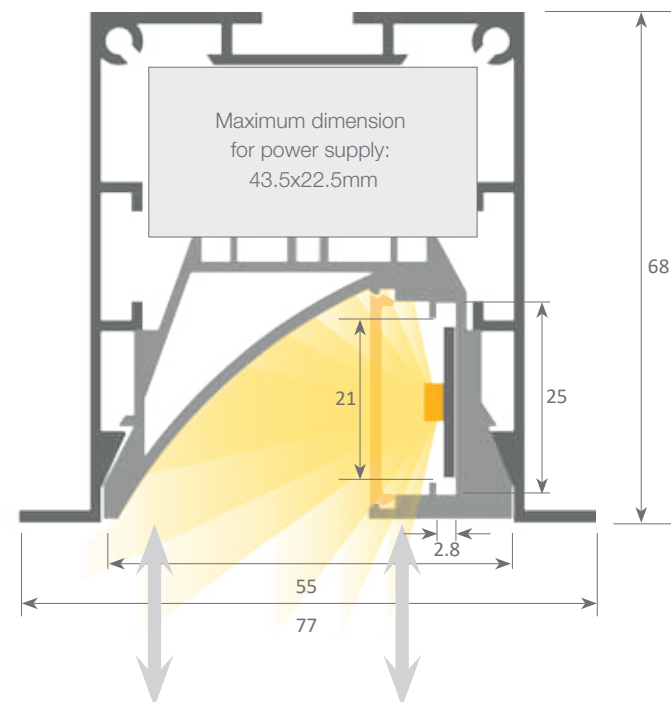

System with front removable tray which permits easy access to the led strip and power supply, therefore allowing very fast and simple maintenance of the electrical installation.



Aluminium alloy extrusion process in accordance with: ISO 9001:2008 - ISO 14001 / Tolerances: UNE-EN 755-9 / UNE-EN 12020-2  
Theoretical weight: 1.202Kg / Alloy: 6060 / Perimeter: 552mm / Anodising minimum: 15 microns  
Purity aluminium: 95-98% / Treatment: T-5

# led profile by Luz Negra

## ANDORRA

Our PROFESSIONAL led profile series for recessing is manufactured in high purity aluminium and lacquered in textured white or grey. We recommend combining this profile with our frosted white cover. This is a large profile which has been designed to hold double rigid led strips in order to achieve high levels of luminosity (especially indicated for shopping malls, supermarkets, etc). Drivers can be housed inside.

Profile and cover are available in lengths of 3.4 metres.

**We offer a 2 year guarantee on profiles and covers.**



### Aluminium profile

14.020	textured grey	3.40m
14.021	textured white	3.40m
14.039	textured black	3.40m



### Inner plate

22.045	aluminium	200cm
--------	-----------	-------



### Polycarbonate cover

18.080	frosted	3.40m
--------	---------	-------



### Joint between profiles

22.044	steel	set of 2 units
--------	-------	----------------

Scale 1:1



### Aluminium endcaps

19.204	grey
19.205	white
19.351	black



### Fixing bracket

20.048	steel
--------	-------



### Plate support

22.047	steel
--------	-------

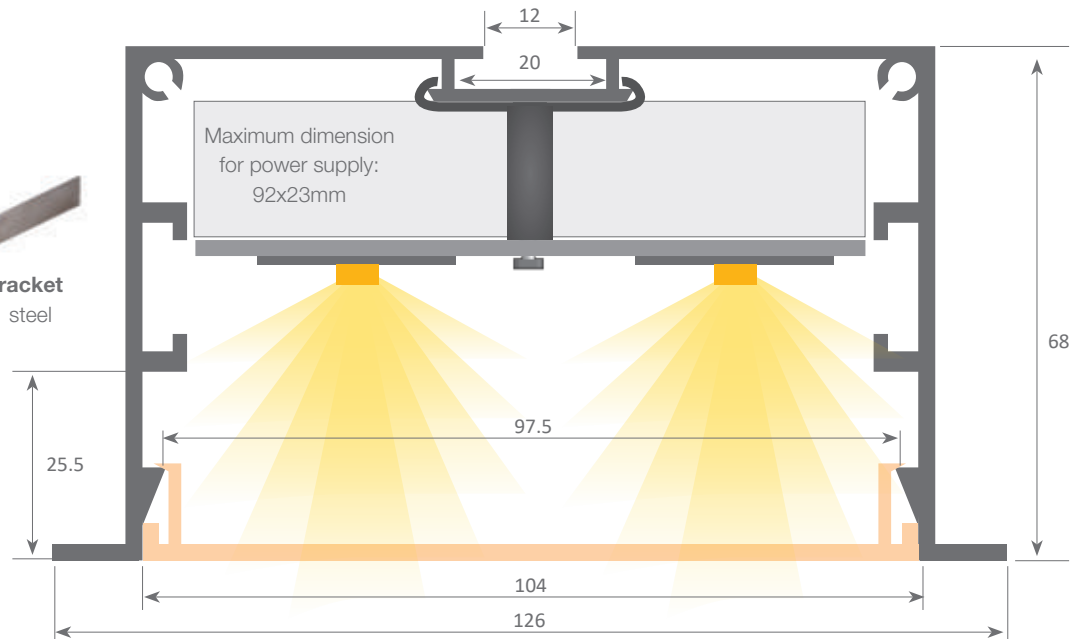

Aluminium alloy extrusion process in accordance with: ISO 9001:2008 - ISO 14001 / Tolerances: UNE-EN 755-9 / UNE-EN 12020-2  
Theoretical weight: 1.399kg / Alloy: 6060 / Perimeter: 650mm / Anodising minimum: 15 microns / Purity aluminium: 95-98% / Treatment: T-5

# led profile by Luz Negra

led profile professional series for surfaces / hanging applications, manufactured in high purity aluminium and black or white textured coating. The drivers can be housed inside. The profile can be used together with 2 different types of 7 module optics, with 65° or 90° degrees. Also, it has a opaque cover of white or black aluminium for those sections we don't want to illuminate. Thanks to the cover, we lower the UGR and glare effects. The tray can be removed from the front, therefore allowing a maintenance work of the profile. Due to safety reasons, we recommend attaching a twisted wire to the heat dissipating tray from the bottom of the profile. The profile and its cover are available in 3.4 meter lengths.

**We offer a 2 year guarantee on profiles and covers.**



## Aluminium profile

14.012 lacquered white 3.40m  
14.013 lacquered black 3.40m



## Aluminium tray

14.033 lacquered white 3.40m  
14.034 lacquered black 3.40m



## Reflector with 7 module

46.066 white 28cm  
46.067 black 28cm



## Blind cover

18.112 white aluminium 3.40m  
18.113 black aluminium 3.40m



## Optics de with 7 module

46.068 65° 28cm  
46.069 90° 28cm

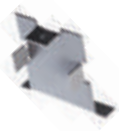

## Aluminium endcaps

19.202 white  
19.203 black



## Profile joints

22.044 steel



## Fixing bracket

20.047 steel



## Safety cable

22.039 steel 18cm



Aluminium alloy extrusion process in accordance with: ISO 9001:2008 - ISO 14001 / Tolerances defined by: UNE-EN 755-9 / UNE-EN 12020-2  
Theoretical weight: 1.202Kg. / Alloy: 6063 / Perimeter: 552 / Anodizing minimum: 15 microns  
Purity aluminium: 95-98% / Treatment: T-5

# KRAKOVIA

with reflector  
and optic

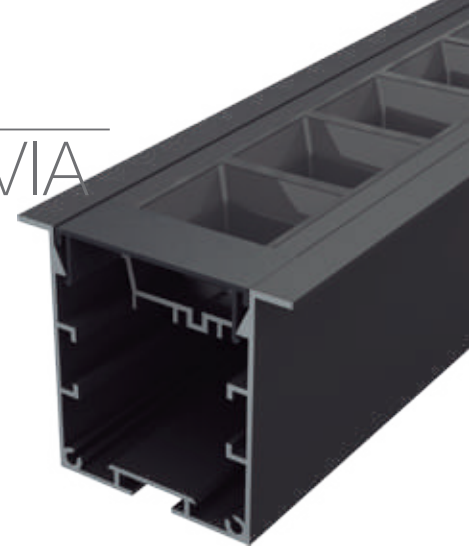

Scale 1:1

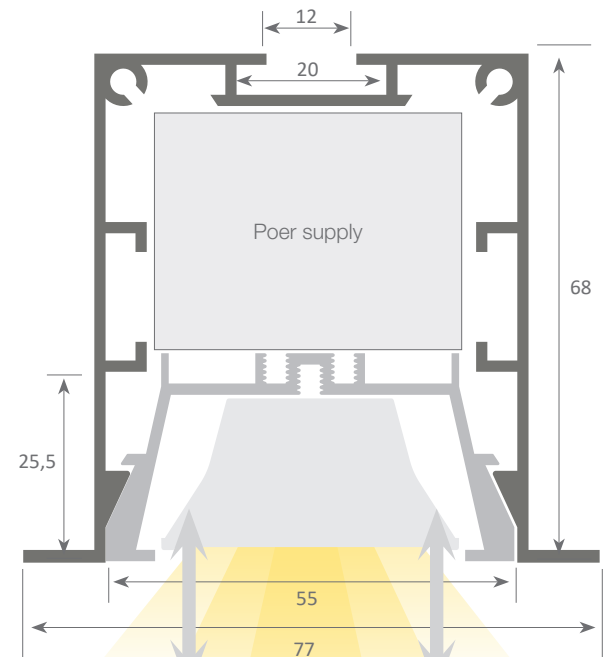

System with front removable tray which permits easy access to the led strip and power supply, therefore allowing very fast and simple maintenance of the electrical installation.





# led profile by Luz Negra

## KIEV

Our PROFESIONAL led profile series for embedding is manufactured in high purity aluminium and black or white lacquered aluminium. Ideal for recessing in low ceilings.

Its cover ("easy-ON" system) in white frosted white, which offers an IP65 to the luminaire, is extremely useful in areas with high humidity levels.

Thanks to its recessed shape and transparent or frosted microprism covers which improves UGR. Both profile and cover are available in 6m lengths, allowing us to carry out long projects without joints.

**We offer a 10 year guarantee on the profile and a 4 year guarantee on the covers.**

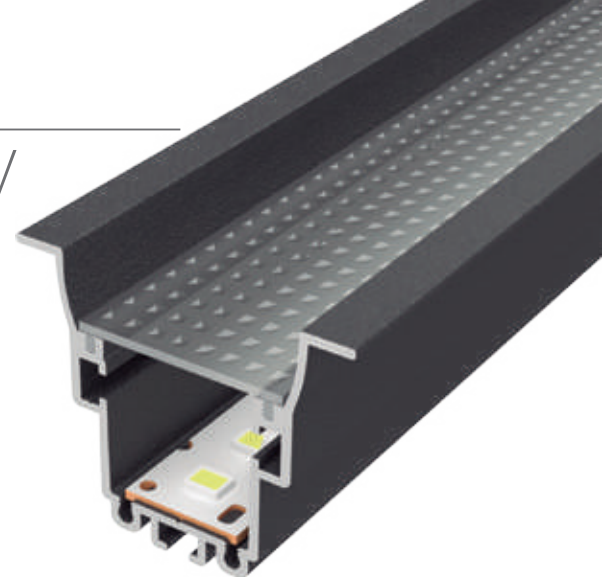

### Aluminium profile

17.060	lacquered white	6m
17.061	lacquered black	6m



### Tapas de metal

19.383	lacado blanco
19.384	lacado negro



### "easy-ON" polycarbonate cover

18.070	"easy-ON" frosted	6m
18.071	transparent microprism	6m
18.072	frosted microprism	6m
18.073	Black&White	6m



### 120° angle bracket

22.004	steel
--------	-------



### Joining

22.005	steel
--------	-------



### Fixing bracket

20.023	for shallow recessing profiles
--------	--------------------------------



### 90° angle bracket

22.003	steel
--------	-------

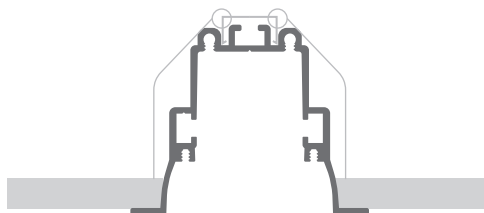

Scale 1:1

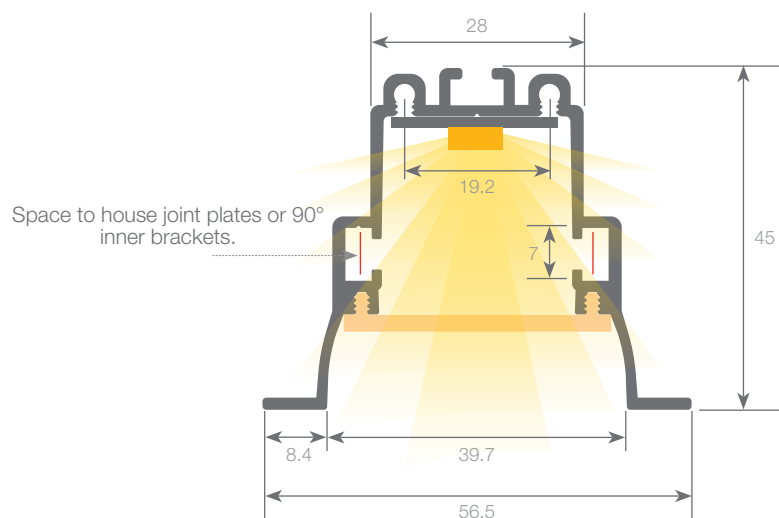

Aluminium alloy extrusion process in accordance with: ISO 9001:2015 / Tolerances: UNE-EN 755-9 / Theoretical weight: 0.734 kg / Alloy: 6063 / Perimeter: 359 mm / Anodised: 10 micras / Purity aluminium: 98.5% / Treatment: T-5



# led profile by Luz Negra

## SIDNEY

Our professional series led profile for recessing, 13mm high only, manufactured in silver anodized or white lacquered aluminium of high purity. Profile and cover available in 2.5m long bars. This profile is ideal for housing 2 led strips inside with a maximum width of 10mm and a power non greater than 40W/m. We recommend to use the profile together with the opal white cover and the ecoled strips Canovelles-Barcelona-Gomera-Cob in order to obtain a more uniform and homogeneous illumination. You can also install it with our 20mm wide rigid led strips (the dots are slightly marked).

**We offer a 2 year guarantee on profiles and covers.**

Scale 1:1

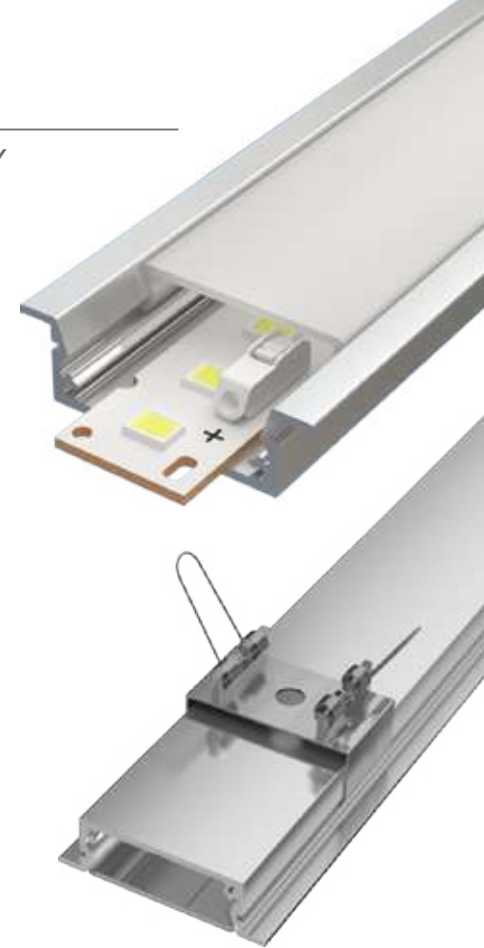
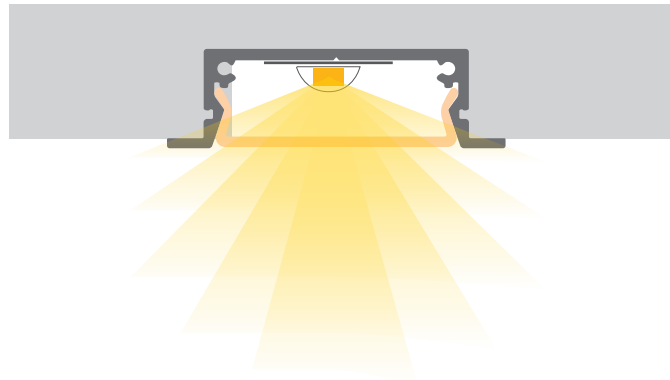
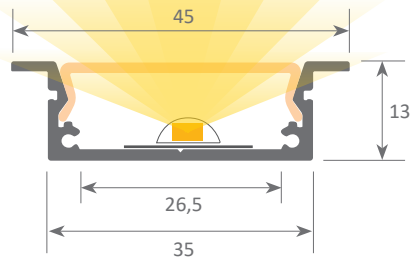

### Aluminium profile

14.040 silver anodised 2,5m  
14.041 white lacquered 2,5m



### Metallic endcaps

19.354 white without hole  
19.355 silver without hole



### Cover

18.117 opal 2,5m



### Fixing bracket

20.069 aluminium



Aluminium alloy extrusion process in accordance with: ISO 9001:2008 - ISO 14001 / Tolerances defined by: UNE-EN 755-9 / UNE-EN 12020-2  
Theoretical weight: 0.33kg / Alloy: 6063 / Anodizing minimum: 15 microns  
Purity aluminium: 95-98% / Treatment: T-5

# shinka **One**light; luminous textile architecture

Innovation  
made  
in  
Spain



Shinka **One**light is a new way of using light where we introduce light boxes with textile fronts instead of using linear and specific light points.

This way, with only just one luminaire, we can achieve the necessary light without having to create different light points in order to avoid interfering with the architectural design of the space.

The vast range of sizes, shapes and colours, make it a luminaire which can be totally personalised.

# shinka **One**light; luminous textile architecture



**Versatile:** suitable for surfaces, walls and hanging applications. It can also be used for recessing.



**Adaptable:** can be used for special geometrical shapes due to the characteristics of both profile and textile.



**Customised:** this luminaire can be used to promote both personalised publicity messages and also decorative lighting statements.



**Dynamic:** inside we can include digital, RG or tunable white (HCL) lighting.



## F10 Profile

Profile for fixing on the perimeter on internal cavities, furniture, etc. This way the textile can be tightened on the front. It is available in 600cm or 300cm lengths and manufactured in silver anodised, textured lacquered white, and textured black. It can be tightened with a silicone strip or a small DUOflex spatula.



## F15 Profile

Profile designed for frames with textile fronts but without lighting. This profile is available in lengths of 300cm and in silver anodised. It can be tightened with a silicone strip. Accesories are available such as brackets and hangers.



## F35 Profile

Profile designed for manufacturing luminaires, with a depth of only 35mm. It is designed to be illuminated with optic methacrylate such as Dotting or similar, using our Granada ecoled on the edge of the methacrylate (LGP). This profile is available in lengths of 600cm and 300cm, in silver anodised, or textured (black or white). It can be tightened with a silicone strip or a small DUOflex spatula. Accesories are available such as brackets and hangers.



## F45 Profile

Profile designed for manufacturing luminaires, with a depth of only 45mm. It is designed with backlighting using ecoled Sideview (rigid led strips with 170° lens). This profile is available in lengths of 600cm and 300cm lengths, in silver anodised, or textured (black or white). It can be tightened with a silicone strip or a small DUOflex spatula. Accesories are available such as brackets and hangers.



## F50 Profile

Profile for manufacturing luminaires with a depth of 50mm with lighting on 2 sides, and which is illuminated with boxed perimetral rigid strips. This profile is available in lengths of 300cm and 600cm, and in silver anodised. It can be tightened with a silicone strip. Accesories are available such as brackets and reinforcements for internal structure.



## F80 Profile

Profile designed for manufacturing luminaires, with a depth of only 80mm, with lighting on one side or two sides. It is illuminated with boxed perimetral rigid strips (2 sides), or with ecoled sideview at he back (1 side). This profile is available in lengths of 600cm and 300cm lengths, in silver anodised, textured lacquered white or textured black. It can be tightened with a silicone strip or a small DUOflex spatula. Accesories are available such as brackets and reinforcements for internal structure.



## F110 Profile

Profile for manufacturing luminaires with a depth of 110mm with lighting on 2 sides, and which is illuminated with boxed perimetral rigid strips. This profile is available in lengths of 300cm and 600cm, and in silver anodised, textured lacquered white or textured black. It can be tightened with a silicone strip or a small DUOflex spatula. Accesories are available such as brackets and reinforcements for internal structure.



## F150 Profile

Profile designed for manufacturing luminaires, with a depth of only 150mm, with lighting on two sides. It is illuminated with boxed perimetral rigid strips. This profile is available in lengths of 600cm and 300cm lengths, in silver anodised, textured lacquered white or textured black. It can be tightened with a silicone strip or a small DUOflex spatula. Accesories are available such as brackets and reinforcements for internal structure.

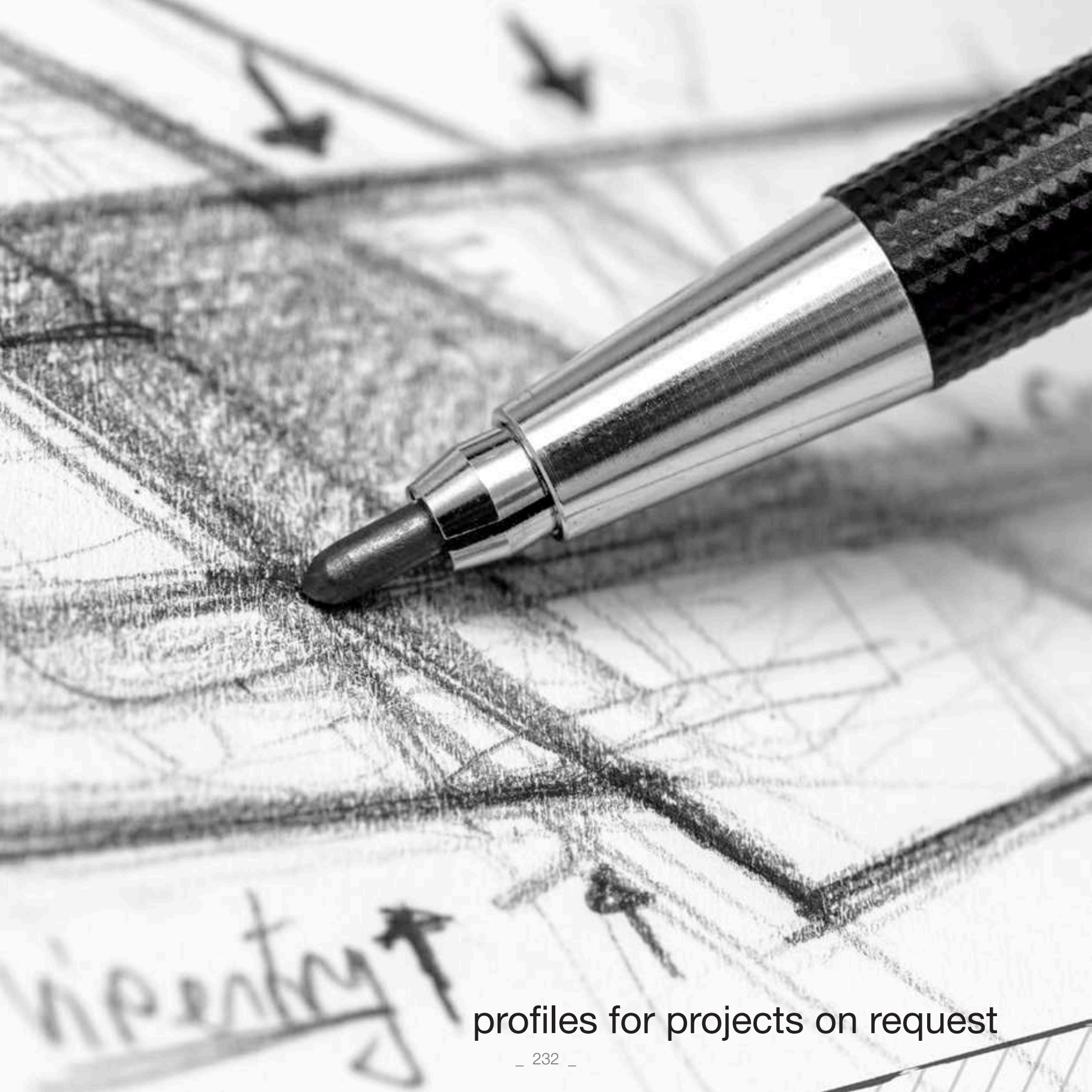

profiles for projects on request



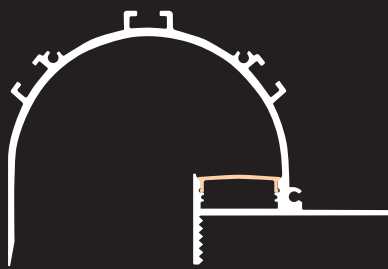

CARACAS

234



BOGOTA

234



ACAPULCO

235

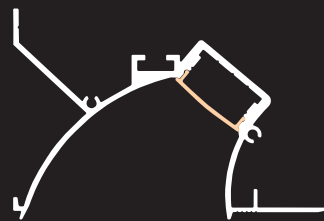

CANCUN

235



TIJUANA

235



QUITO

236



MEDELLIN

236



BRASILIA

236



SANTIAGO

237



CALI

237



CUZCO

237

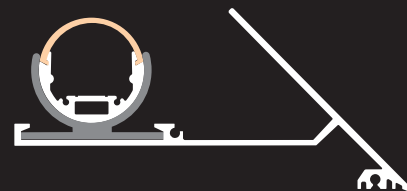

LIMA

238



CARTAGO

238

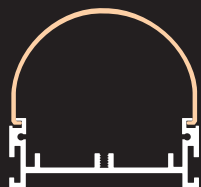

NASAU

239



MONTEVIDEO

239

Here at Luz Negra we have a large number of profile matrices available on request (in addition to being able to manufacture any size according to our clients' needs).

All the profiles in this section are aimed at projects. Although we don't actually hold in our current stock, they can be supplied under petition with an approximate lead time of 60-90 days.

Although the bars are normally manufactured in aluminium, we can look at different colour options and also the possibility of offering other lengths.

There is a minimum order (MOQ) of approximately 100 metre per reference. If you would like any of these profiles or any another, not already available in our full catalogue, please consult our commercial department and we will surely find the best solution for you.

## CARACAS

Aluminium led profile + cover intended for illuminating ceiling perimeters in rooms, giving diffused and ambience lighting. It is finished off with a layer of plaster making it completely integrated in the wall.

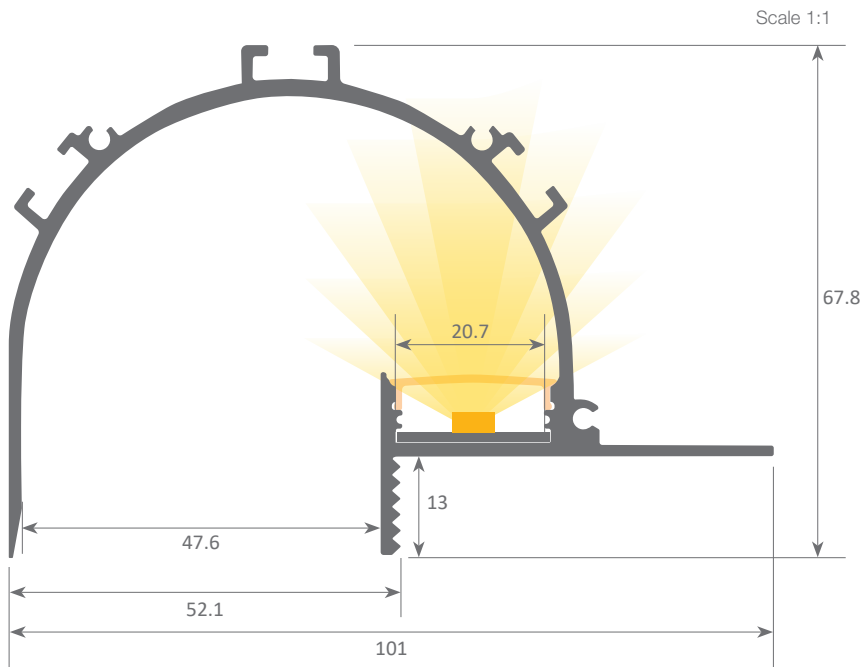

### Aluminium profile

08.011 aluminium 3m

### Cover

18.089 frosted 3m

### Plastic endcaps

19.255 with hole

19.256 without hole

### Clip

20.055 metal (para fijación a la pared)

20.058 metal (fijación al techo)

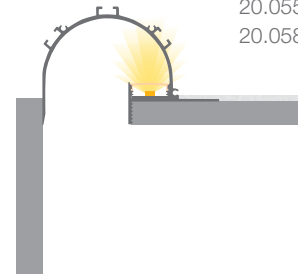

Scale 1:1

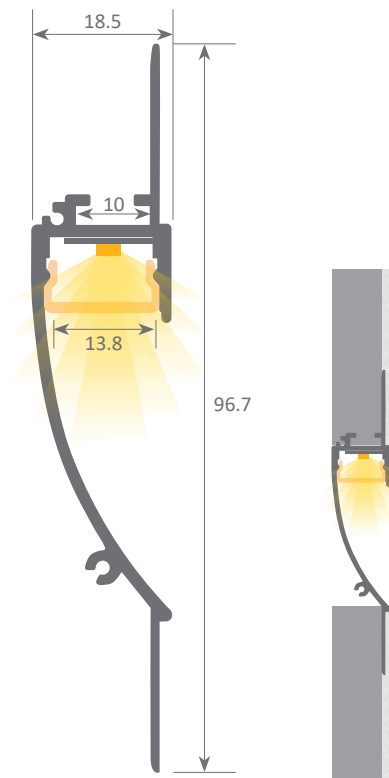

## BOGOTA

Aluminum led profile + cover for recessing in walls and designed to offer indirect and soft linear lighting. It is finished off with a layer of plaster making it completely integrated in the wall.

### Aluminium profile

08.010 aluminium 3m

### Cover

18.088 frosted 3m

### Plastic endcaps

19.253 with hole

19.254 without hole

Scale 1:1

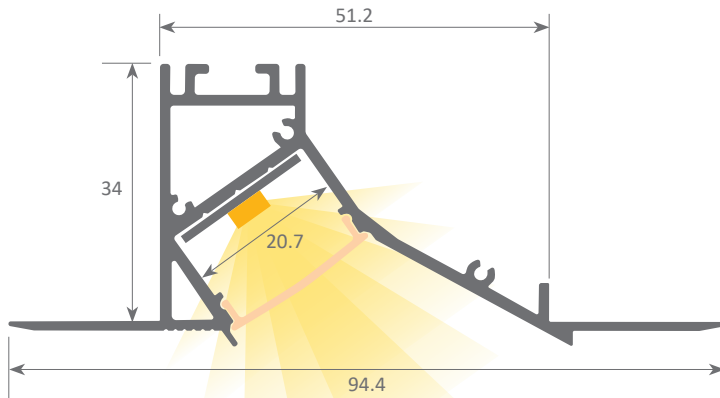

## ACAPULCO

Aluminum led profile + cover designed to offer indirect and soft linear lighting. It is finished off with a layer of plaster making it completely integrated in the wall. It can be used on walls or ceilings.

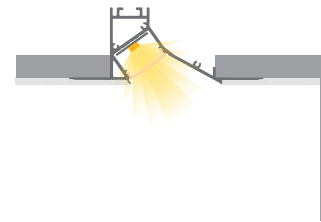

### Aluminium profile

08.012 aluminium 3m

### Cover

18.090 frosted 3m

### Plastic endcaps

19.257 with hole

19.258 without hole

Scale 1:1

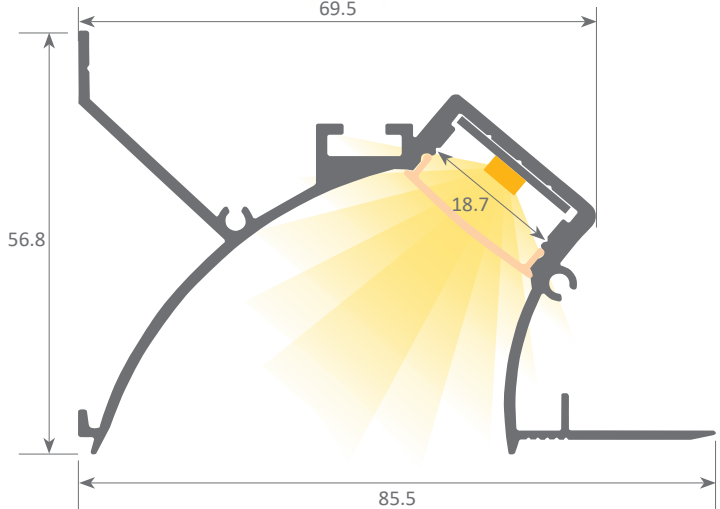

## CANCUN

Aluminium led profile + cover intended for illuminating ceiling perimeters in rooms, giving diffused and ambience lighting. It is finished off with a layer of plaster making it completely integrated in the wall.

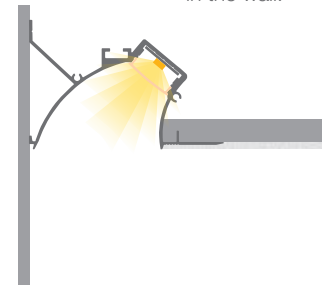

### Aluminium profile

08.013 aluminium 3m

### Cover

18.091 frosted 3m

### Plastic endcaps

19.259 with hole

19.260 without hole

Scale 1:1

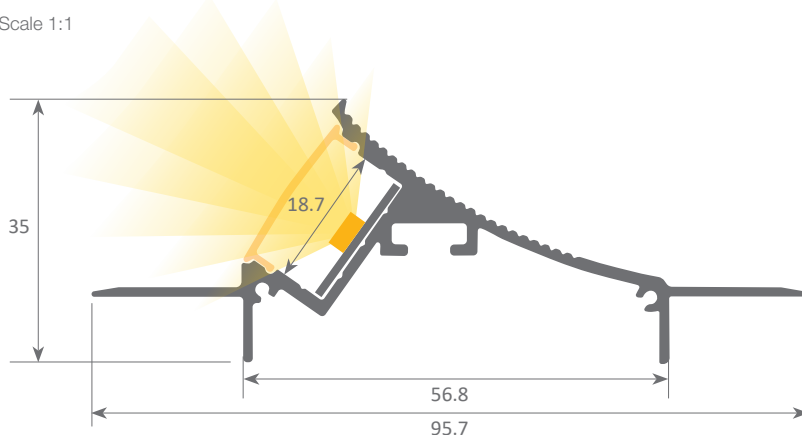

## TIJUANA

Aluminum led profile + cover designed to offer indirect and soft linear lighting. It is finished off with a layer of plaster making it completely integrated in the wall. It can be used on walls or ceilings.



### Aluminium profile

08.014 aluminium 3m

### Cover

18.092 frosted 3m

### Plastic endcaps

19.261 with hole

19.262 without hole

Scale 1:1

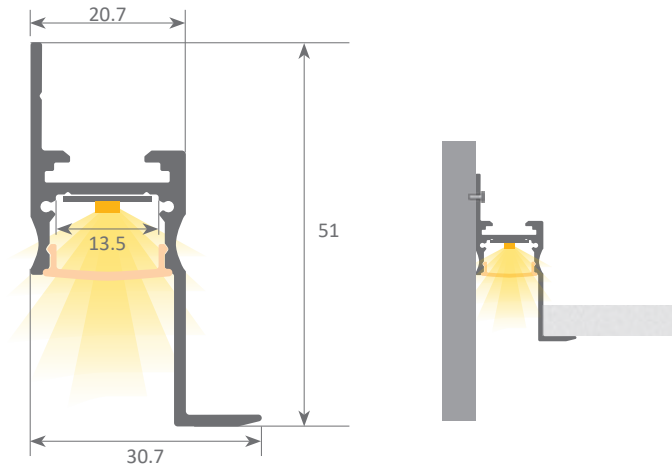

## QUITO

Aluminium led profile + cover intended for illuminating ceiling perimeters in rooms, giving diffused and ambience lighting. It is screwed directly on to the wall and can be finished using ceiling panels such as Armstrong or Pladur drywall plates.

### Aluminium profile

08.015 aluminium 3m

### Cover

18.093 frosted 3m

### Plastic endcaps

19.263 with hole

19.264 without hole

Scale 1:1

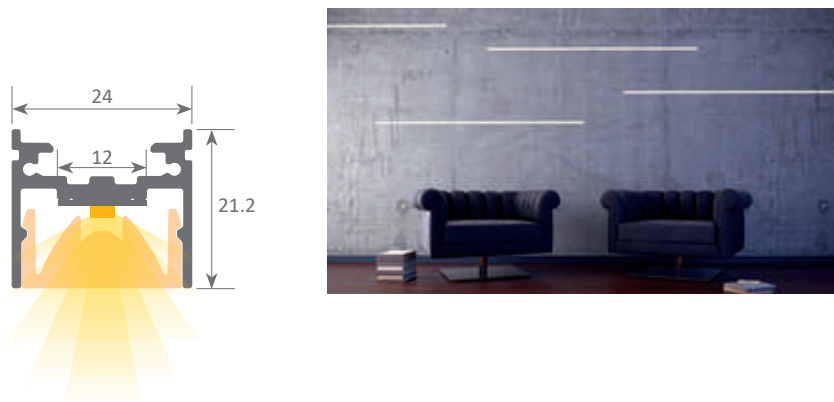

## MEDELLIN

Led profile + different covers which, using high luminosity rigid strips, projects the light over long distances.

### Aluminium profile

08.021 aluminium 3m

### Methacrylate cover

18.099 30° lens 3m

18.104 60° lens 3m

18.107 wallwasher 3m

### Polycarbonate cover

18.106 opal 3m

### Plastic endcaps

19.275 with hole

19.276 without hole

Scale 1:1

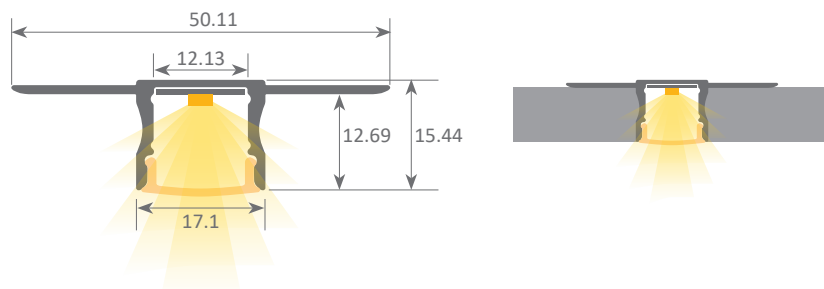

## BRASILIA

Aluminium led profile + cover for ceiling applications which remains flush with conventional plasterboard.

### Aluminium profile

08.017 aluminium 3m

### Cover

18.095 frosted 3m

### Plastic endcaps

19.267 with hole

19.268 without hole

Scale 1:1

## SANTIAGO

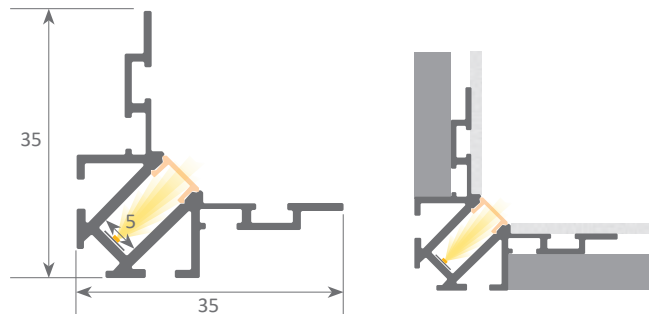

Aluminium led profile + cover for interior architectural corner applications. It is finished off with a layer of plaster making it completely integrated in the wall.

**Aluminium profile**

08.018 aluminium 3m

**Cover**

18.096 frosted 3m

**Plastic endcaps**

19.269 with hole

19.270 without hole

Scale 1:1

## CALI

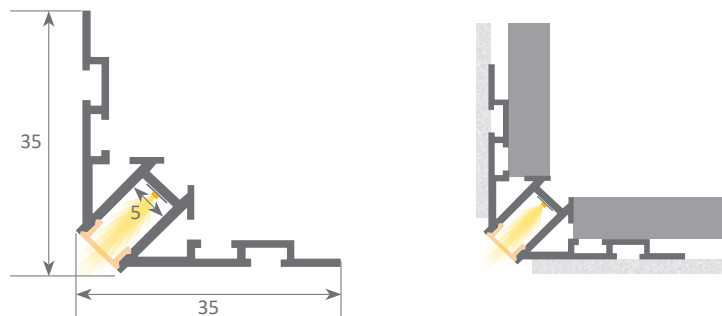

Aluminium led profile + cover for interior architectural corner applications. It is finished off with a layer of plaster making it completely integrated in the wall.

**Aluminium profile**

08.019 aluminium 3m

**Cover**

18.096 frosted 3m

**Plastic endcaps**

19.271 with hole

19.272 without hole

Scale 1:1

## CUZCO

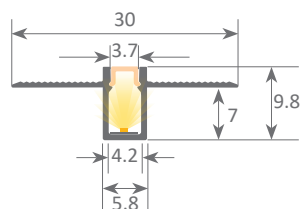

Aluminium led profile + cover for ceiling applications which remains flush with conventional plasterboard. As its light line is only 3.7mm wide, this makes it a very fine and elegant lighting option.

**Aluminium profile**

08.020 aluminium 3m

**Cover**

18.098 frosted 3m

**Plastic endcaps**

19.273 with hole

19.274 without hole

## LIMA

Aluminium led profile base + adjustable led profile with cover, intended for perimeter ceiling lighting in rooms, offering diffused and ambience lighting. It should rest on a ledge or similar. Its diagonal shaped finishing, means that illumination is totally indirect.

Scale 1:1

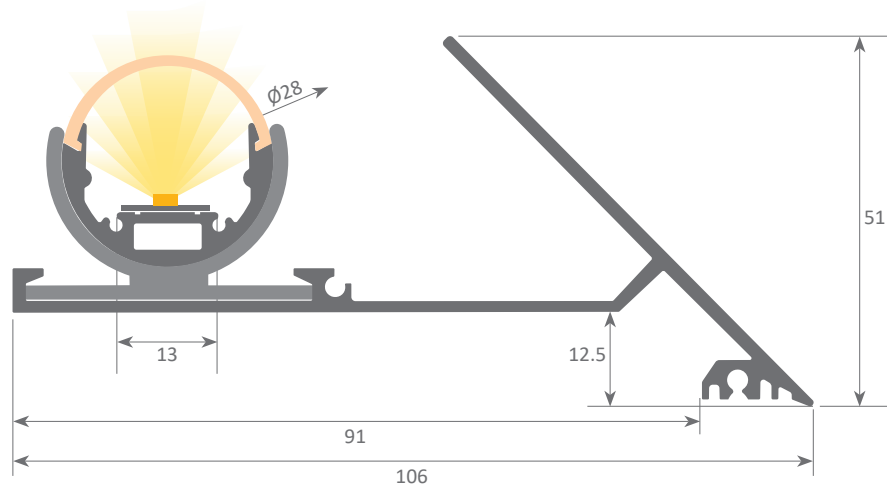

### Aluminium profile (Base)

08.016 aluminium 3m

### Aluminium profile (Semicircular)

08.031 aluminium 3m

### Cover

18.094 opal 3m

### Methacrylate cover

18.099 30° lens 3m

18.104 60° lens 3m

18.107 wallwasher 3m

### Plastic endcaps

19.265 with hole

19.266 without hole

### Clip

20.054 transparent plastic

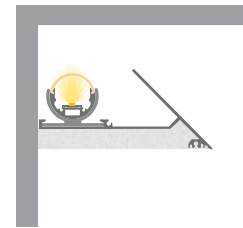

Scale 1:1

## CARTAGO

Led profile made up of an internal aluminium core with an opal white cover which give us a cylinder with 360° light. Its metal end caps allow power supplies to be housed inside.

### Aluminium profile

08.022 aluminium 3m

### Cover

18.100 frosted 3m

### Plastic endcaps

19.277 without hole

### Hanging kit

21.005 silver

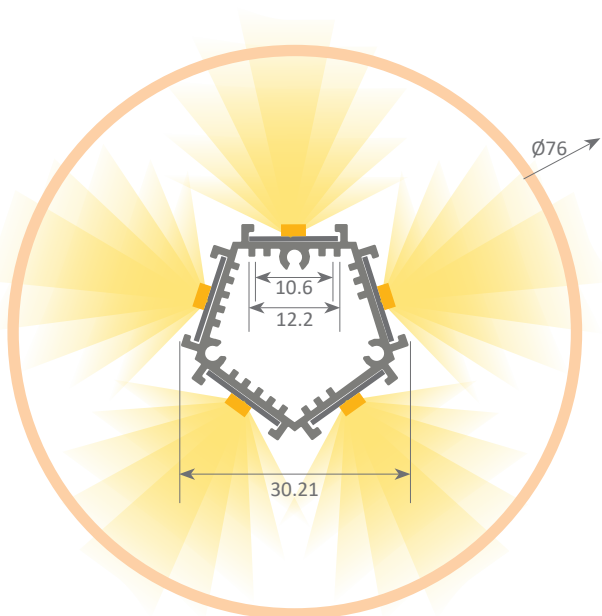

Scale 1:1

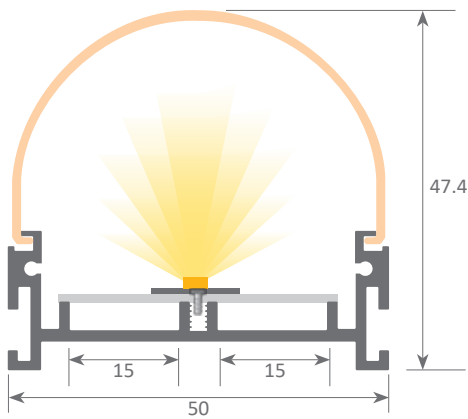

## NASAU

Aluminum profile + cover for perimeter lighting on facades, buildings or similar.

**Aluminium profile**

08.029 aluminium 3m

**Polycarbonate cover**

18.105 frosted 3m

**Plastic endcaps**

19.291 with hole

19.292 without hole

**Clip**

20.057 metal

Scale 1:1

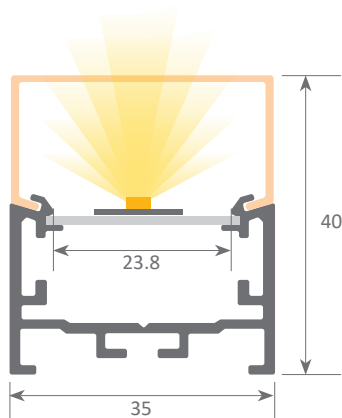

## MONTEVIDEO

Aluminum profile + cover for perimeter lighting on facades, buildings or similar.

**Aluminium profile**

08.030 aluminium 3m

**Polycarbonate cover**

18.101 frosted 3m

**Plastic endcaps**

19.284 without hole

**Clip**

20.056 metal

# led profile sample display cases

## Panels with led profiles

For our clients we have display panels available with our most popular led profiles (includes led lighting):

Ref: 22.062

Panel measurements: 100x50cm

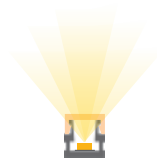

Detroit  
See page 62



Tennessee  
See page 63



Milano  
See page 44



Frankfurt  
See page 71



Roma  
See page 48



Berlin  
See page 73



Torino  
See page 60

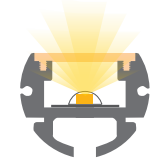

Paris  
See page 94



Zagreb  
See page 90

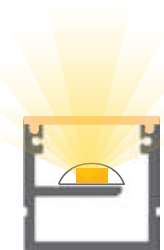

Versalles  
See page 54

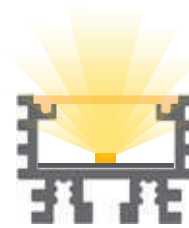

Inferno  
See page 56



Sophia XL  
See page 84



# led profile sample display cases

## Panels with Big profiles

For our clients we have display panels available with our most popular big profiles (includes led lighting):

Ref: 22.063

Panel measurements: 100x50cm

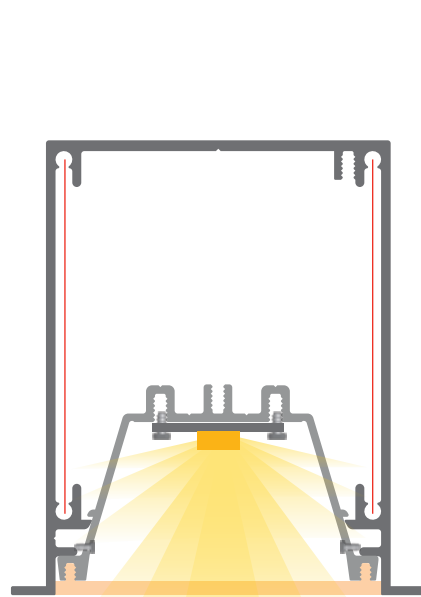

Moscú Magnum  
See page 218

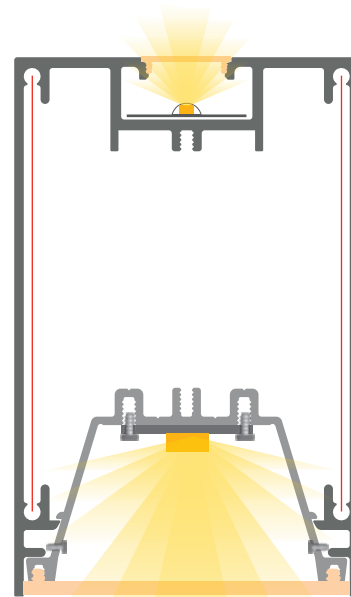

Múnich Magnum  
See page 196

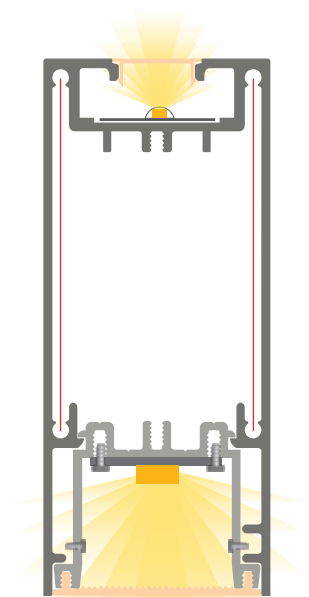

Múnich Magnum Slim  
See page 194

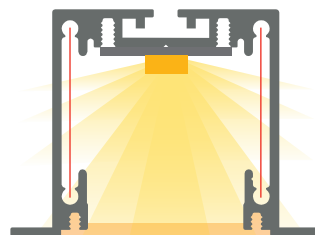

Moscú Mini  
See page 214

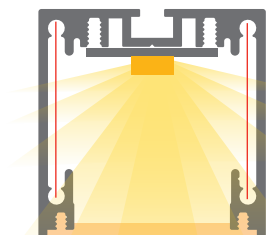

Múnich Mini  
See page 192

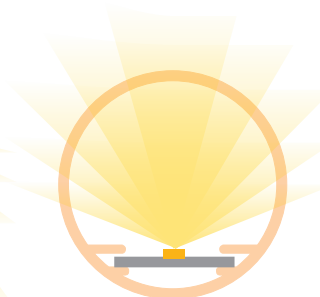

Oslo  
See page 103

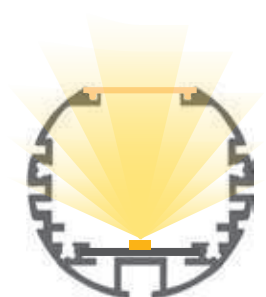

Paris XL  
See page 100

# led profile sample display cases

## Panels with architectural profiles

For our clients we have display panels available with our most popular architectural profiles (includes led lighting):

22.064

Panel measurements: 100x50cm

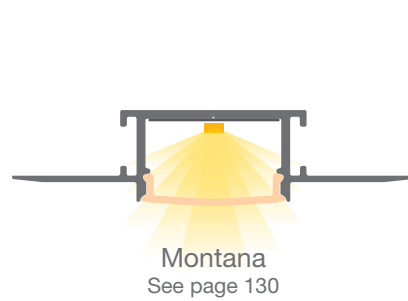

Montana  
See page 130

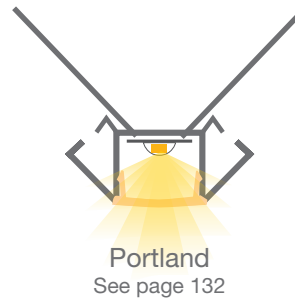

Portland  
See page 132

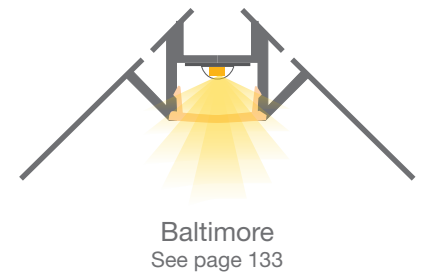

Baltimore  
See page 133



Alaska  
See page 131

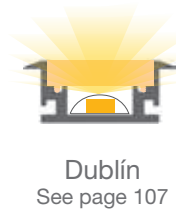

Dublín  
See page 107



Florencia  
See page 112

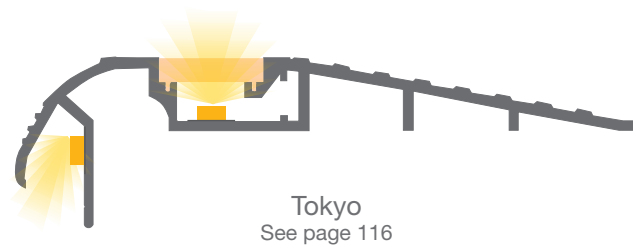

Tokyo  
See page 116



## Multi-Sample display cases

We have sample cases available for our clients with our most popular profiles (38 models) + technical drawings on a scale of 1:1:

Ref: 22.065

Measurements: 42x30cm

## Personalised profile samples

50cm length with Barcelona ecoled in neutral white, fixing clips, bluetouch dimmer switch and power supply.

Includes 1 transparent and 1 frosted cover.

Model of led profile: to be chosen by client.

Colour of profile: to be chosen by client.

Ref: 22.066

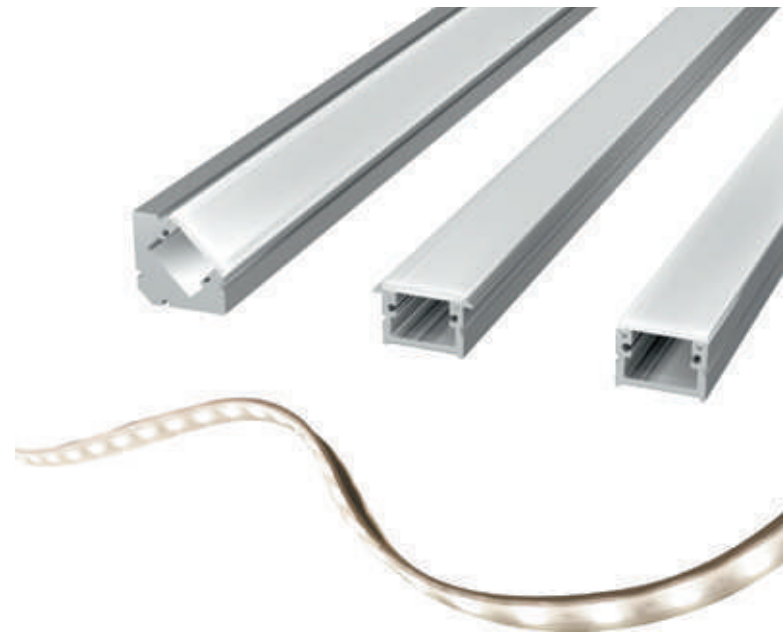

## Free profile samples

At Luz Negra we are specialists in linear lighting and we offer very high quality profiles and covers which we are sure will meet your expectations.

We therefore offer you free 15cm samples so you can assess before executing any project, to make sure they fit to perfection (service for professionals).

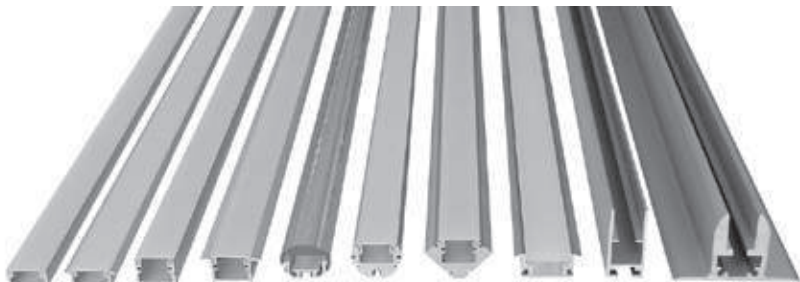

#### **LUZ NEGRA (BARCELONA)**

Polígono Industrial Can Castells  
Carles Buñigues, 13  
08420 Canovelles - Barcelona  
Tel.: +34 938 402 598  
info@luznegra.net

#### **LUZ NEGRA CENTRO (MADRID)**

Polígono los Olivos  
C/ Adaptación, 27  
28906 Getafe - Madrid  
Tel.: +34 916 416 081  
centro@luznegra.net

#### **LUZ NEGRA FRANCE (PARIS)**

113 Avenue Joffre  
77450 Esbly - Paris  
Tel.: +33 (0) 187 652 034  
france@luznegra.net

[www.luznegra.net](http://www.luznegra.net)

Member of:



APDI

Professional association of  
lighting designers



/ledprofile



led\_profile



luznegra



Luz Negra ecoLED