

REMOTE CONTROL RGB/RGBW

SEQUENCERS

Ref: 41.095

3V

- For dual colour (warm white + cool white) led controllers.
- Ultra-sensitive colour adjustment touch wheel.
- Each remote can match one or more receivers.
- CR2032 battery powered.
- Operates with led indicator light.

Compatible with receiver:

- 41.096



voltage



IP20

Voltage (V)	3V
Control	2.4GHz
Working current	< 5mA
Standby current	< 10µA
Distance control	30m
Measurements	107x58.5x9mm
Working temperature	-30°C / +55°C
Wall bracket	yes
Memory	yes
Control intensity	yes
Receiver included	no
Waterproofing	IP20
Packaging	1 unit
Guarantee	3 years

Approved by: 

Measurements:

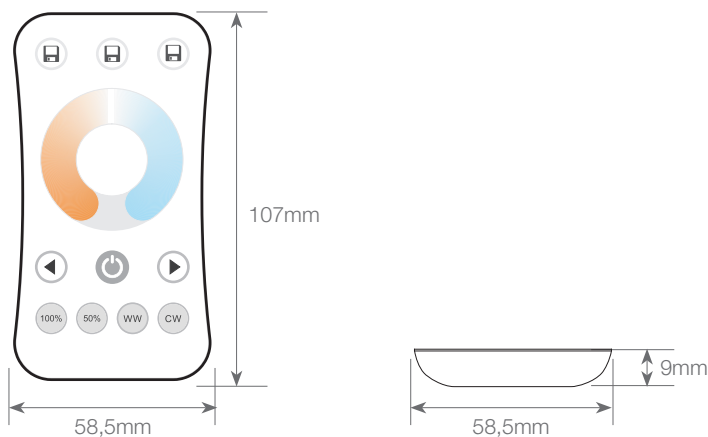

BARCELONA
C/ Carles Buhigues, 13
08420 Canovelles
Info@luznegra.net
Tel: +34 938 402 598

MADRID
C/ Adaptación, 27
28906 Getafe
centro@luznegra.net
Tel: +34 916 416 081

PARIS
113 Avenue Joffre
77450 Esbly
france@luznegra.net
Tel: +33 (0) 160 426 585

REMOTE CONTROL RGB/RGBW

SEQUENCERS

Mechanical installations

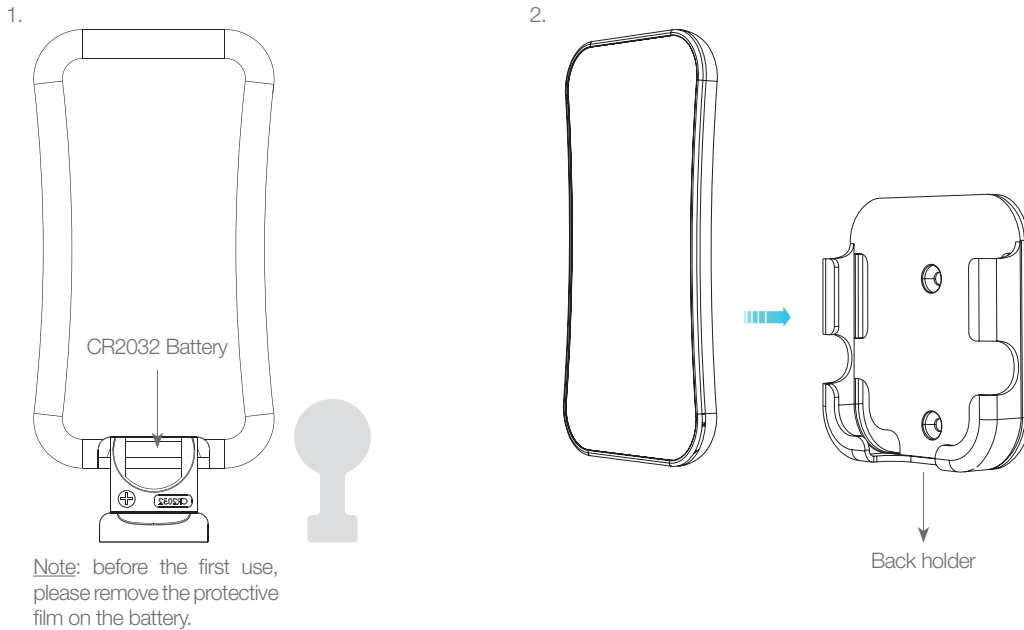

The remote can be fixed in 2 different ways:

1. By fixing the remote's back holder onto the wall with 2 screws.
3. By gluing the remote's holder to the wall.

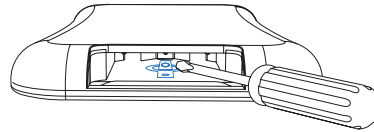

Working

- When light is on, touch the colour wheel, the indicator will display red.
- To extend battery life, no touch or press key operation after a few seconds, the touch wheel will enter sleep mode, you need to press any key to make touch wheel quit sleep mode.

Match remote control (2 options)

The end user can choose the suitable match/delete options. Two options are offered:

1. Use the controller's match key

Match: short press match key, immediately press on/off key (single zone remote) or zone key (multiple zone remote) on the remote. The led indicator fast flashes a few times meaning match is successful.

Delete: press and hold match key for 5s to delete all matches, The led indicator fast flashes a few times meaning all matched remotes were deleted.

2. Use power restart

Match: switch off the power, then switch on power, repeat again. Immediately short press on/off key (single zone remote) or zone key (multiple zone remote) 3 times on the remote. The light blinks 3 times meaning match is successful.











Delete: switch off the power, then switch on power, repeat again. Immediately short press on/off key (single zone remote) or zone key (multiple zone remote) 5 times on the remote. The light blinks 5 times meaning all matched remotes were deleted.

REMOTE CONTROL RGB/RGBW

SEQUENCERS

Diagram:



-  Turn on/off light.
-  Touch to change colour temperature.
-   Adjust brightness, short press 10 levels, long press 1-6s for continuous 256 levels adjustment.
-   Get 100% or 50% brightness.
-  Get warm white directly.
-  Get cool white directly.
-    Short press to recall the scene, long press 2s saves the current colour into the scene. the led indicator will light up longer when saved OK.

Safety information

1. Read all instructions carefully before you begin this installation.
2. When installing battery, pay attention to the battery's positive and negative polarities.
If the remote is out of use for a long time, remove the battery.
When the remote distance becomes less and it does not detect, replace the battery.
3. If there is no response from the receiver, please re-match the remote.
4. Handle the remote gently. Do not drop.
5. Only for indoor use and in dry locations.