

**MEDIUM BRIGHTNESS**

**CRETA**

**FLEXIBLE STRIP**

Ref: 31.150

2300°K / 6000°K

**Led strip only for "H" connections.**

Single-coloured flexible strip "PRO"  
IP20 with 240 leds/metre 2835SMD.

Requires use with led profile to permit dissipation.

**Heat dissipation tape included.**

**5mm PCB**

Daily recommended use: 18h  
Maximum connection in open circuit: 2.5m  
Maximum connection in closed circuit: 5m  
Estimated lifespan: 30000h \*

\* Depending on the dissipation of the profile, the daily working hours and the external environmental working temperature.

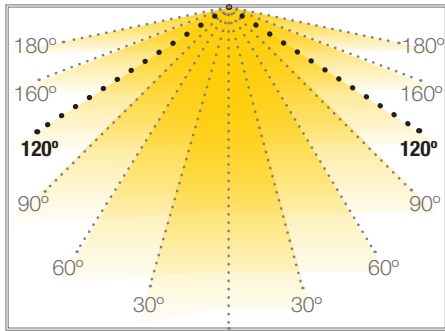

Power (W)	10W/m
Voltage (V)	12V
Led type	SMD2835
Lumens (2300K)	713 Lm/m
Lumens (6000K)	796 Lm/m
Light emission	120°
Waterproofing	IP20
CRI	>90
N° leds/m	240/m
Measurements	5000x5x1.4mm
Cuttable	every 25mm
PCB	5mm
Working temperature	-25°C / +45°C
Apt for	indoor
Packaging	1 roll/5m
Guarantee	3 years

Approved by:

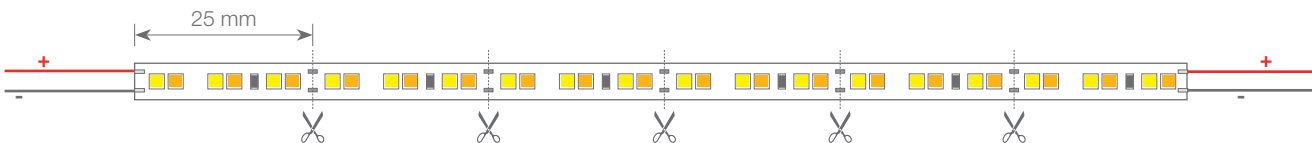
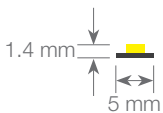

**BARCELONA**  
C/ Carles Buhigues, 13  
08420 Canovelles  
Info@luznegra.net  
Tel: +34 938 402 598

**MADRID**  
C/ Adaptación, 27  
28906 Getafe  
centro@luznegra.net  
Tel: +34 916 416 081

**PARIS**  
113 Avenue Joffre  
77450 Esbly  
france@luznegra.net  
Tel: +33 (0) 160 426 585

**MEDIUM BRIGHTNESS**

**CRETA**

**FLEXIBLE STRIP**

**Features**

Ecoled Creta is a flexible CTT led strip that is only controlled (lit) by two wires. A positive wire and a negative wire.

**How do we perform temperature control when we only have two wire?**

By means of an "H" connection. They are widely used in engines.

**What is a bridge or 'H' connection?**

- **H-bridge (electronics)**: is an electronic circuit generally used to allow a DC electric motor to rotate in both forward and reverse directions. They are widely used in robotics and as power converters. H-bridges are available as integrated circuits, but can also be built from discrete components.

1. Structure of an 'H' bridge (marked in red).

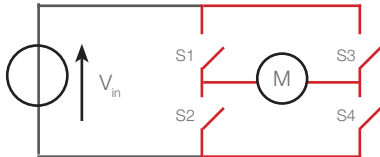

The term 'H-bridge' is derived from the typical graphical representation of the circuit. An 'H' bridge is constructed with 4 switches (mechanical or transistor). When switches S1 and S4 are closed (and S2 and S3 open) a positive voltage is applied to the motor, causing it to rotate in one direction. By opening switches S1 and S4 (and closing S2 and S3), the voltage is reversed, allowing the motor to rotate in the reverse direction.

2. The 2 basic connections of the circuit.

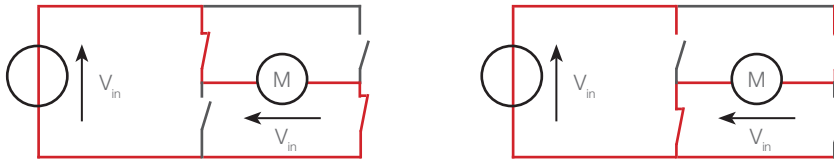

**What does it mean, applying this to a led strip?**

As we already know, all leds strips have a positive and a negative connection, as we can see in the image the below. We must place the positive cable of our power supply with the positive of the flexible strip and with the negative the same.

With our ecoled strip Creta, depending on how we connect the cables of the power supply to the strip, we will make it light up in one tone or another, as it can be connected in 'H' and as it has a small integrated circuit which determines in which tone it has to light up. If we generate voltages in the following ways, we will obtain one tone or another.

CW

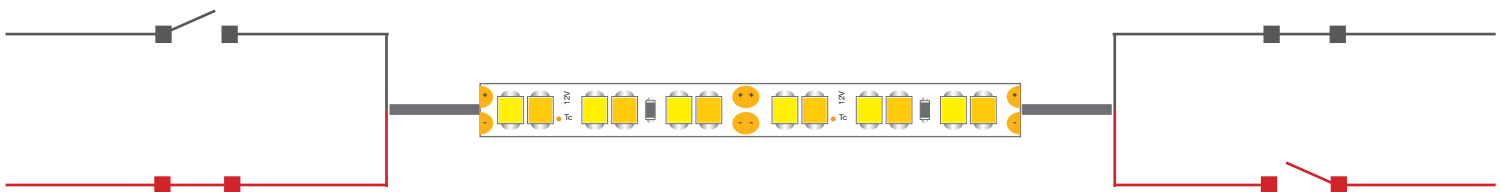
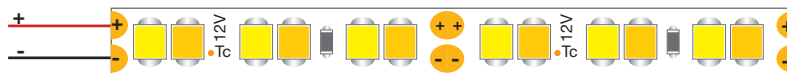

WW

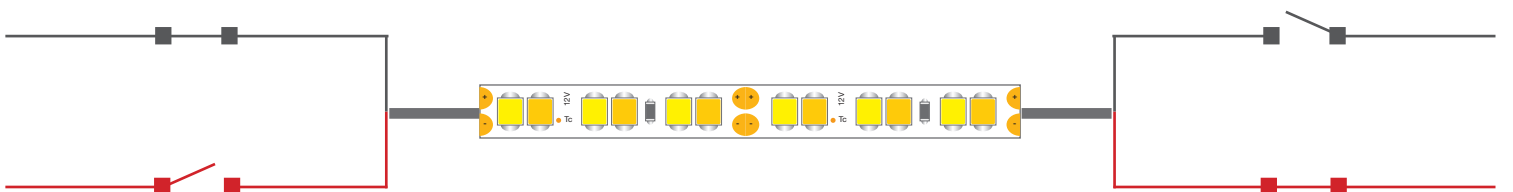
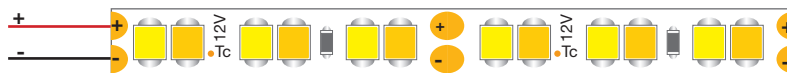

## MEDIUM BRIGHTNESS

## CRETA

## FLEXIBLE STRIP

### How to obtain the neutral tonality

It cannot be generated directly by taking voltage from the power supply, because if we try to make the two connections simultaneously to the same source or independent sources, they short-circuit.

### Compatible controllers



41.095



41.096

### Type of connections:

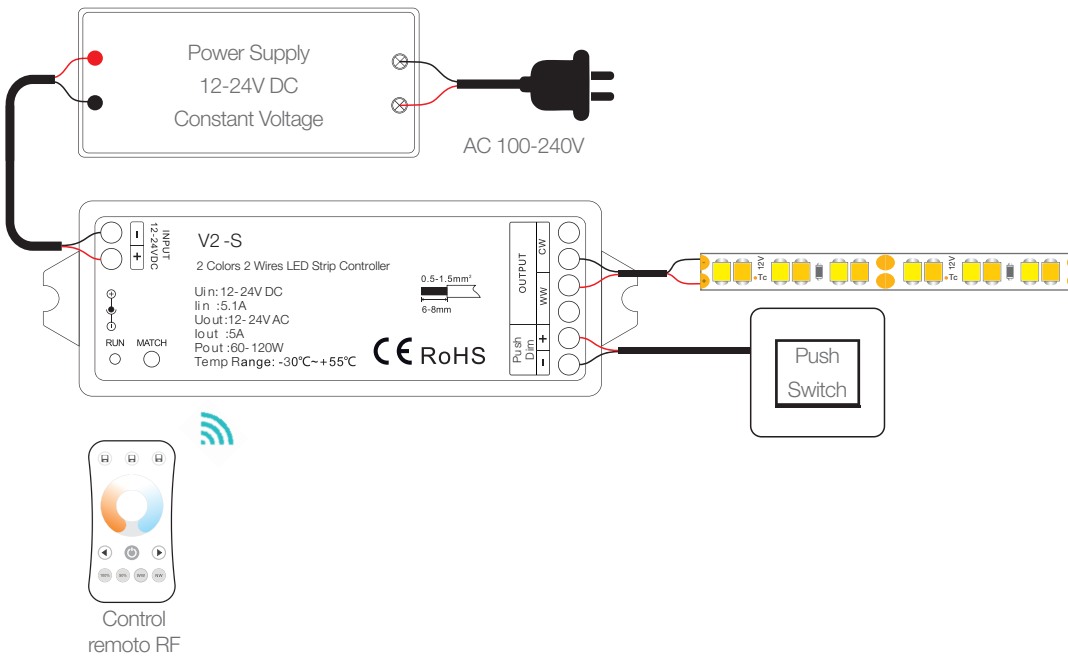

**Spectrum Test Report**

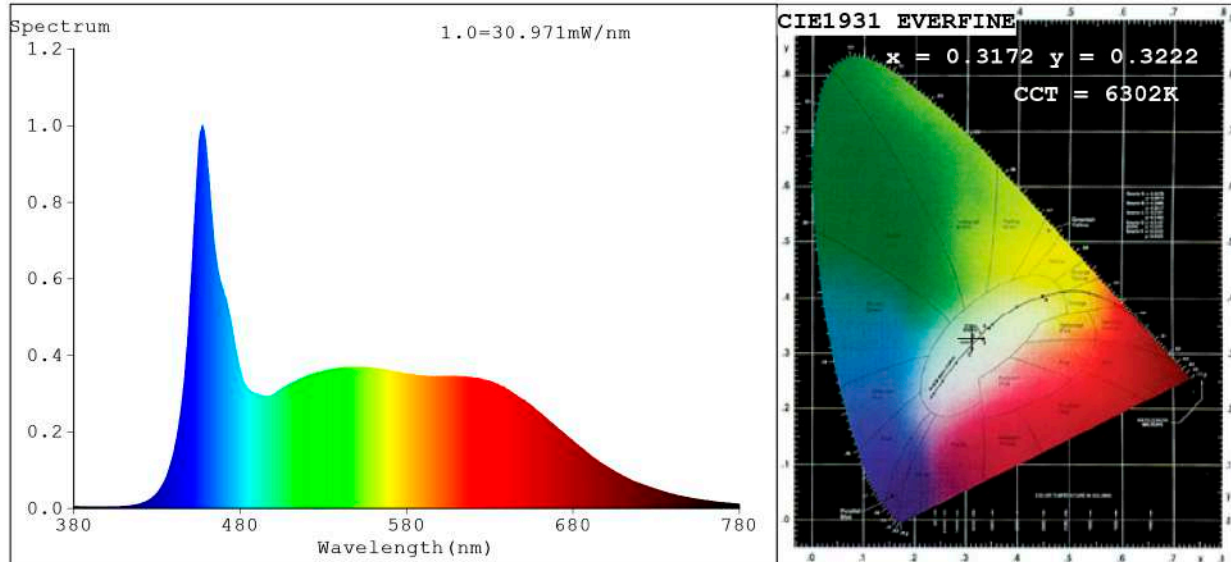

**Color Parameters:**

Chromaticity Coordinate: $x=0.3172$   $y=0.3222$ / $u'=0.2036$   $v'=0.4653$   
 CCT=6302K(Duv=-0.0027) Dominant WL:Ld =482.2nm Purity=6.4%  
 Ratio:R=16.4% G=76.0% B=7.5%; Peak WL:Lp=457.7nm FWHM=24.9nm  
 Render Index:Ra=91.8 CRI=90.8 TM30:Rf=87 Rg=99 Lav=549.5nm  
 R1 =94 R2 =94 R3 =96 R4 =88 R5 =91 R6 =91 R7 =89  
 R8 =91 R9 =94 R10=91 R11=92 R12=66 R13=95 R14=99 R15=92

**Photo Parameters:**

Flux = 796.2 lm Eff. : 96.71 lm/W Fe = 2.959 W Scotopic:1946.5 S/P:2.4447

**Electrical parameters:**

V = 11.998 V I = 0.6862 A P = 8.233 W PF = 1.000

Status: Integral T = 1000 ms Ip = 47668 (73%)

Model:Ecoled Creta (CW)  
 Tester:Sergio Carneros  
 Temperature:25Deg  
 Manufacturer:Luz Negra.S.L

Number: 31.150  
 Date:2022-06-01 13:50:24  
 Humidity:57%  
 Remarks:100cm Tira flexible

Rf: 87      CCT: 6302 K      u': 0.2036  
Rg: 99      Duv: -0.0027      v': 0.4653

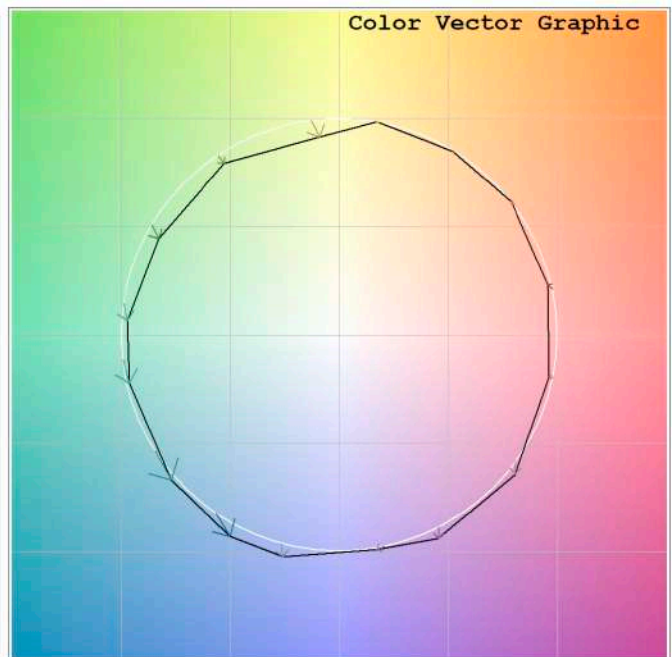
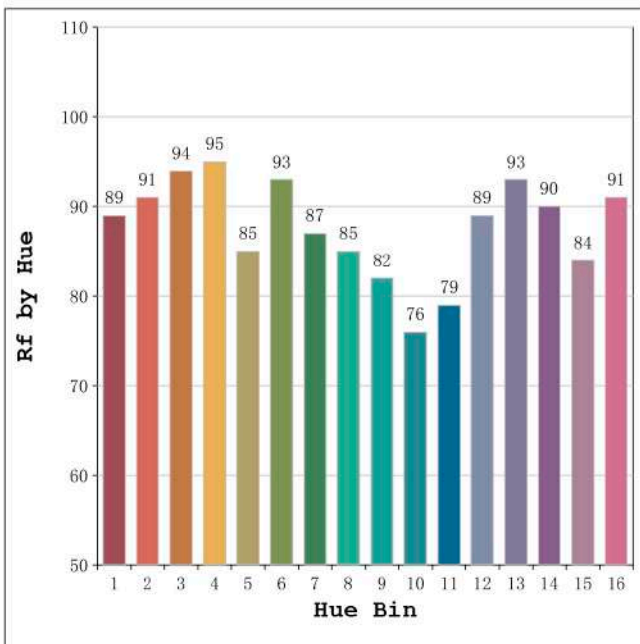
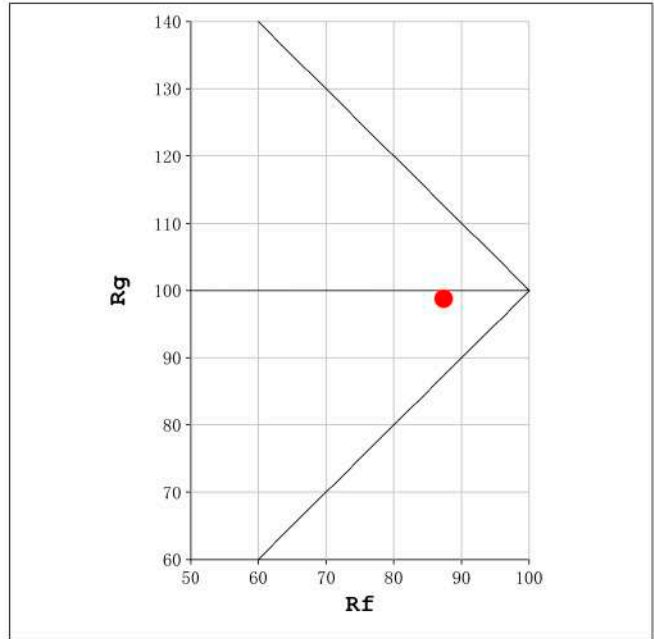
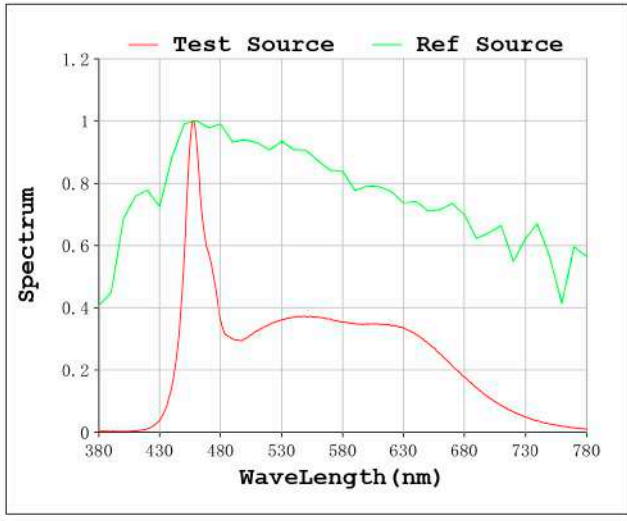

Model:Ecoled Creta (CW)  
Tester:Sergio Carneros  
Temperature:25Deg  
Manufacturer:Luz Negra.S.L

Number: 31.150  
Date:2022-06-01 13:50:24  
Humidity:57%  
Remarks:100cm Tira flexible

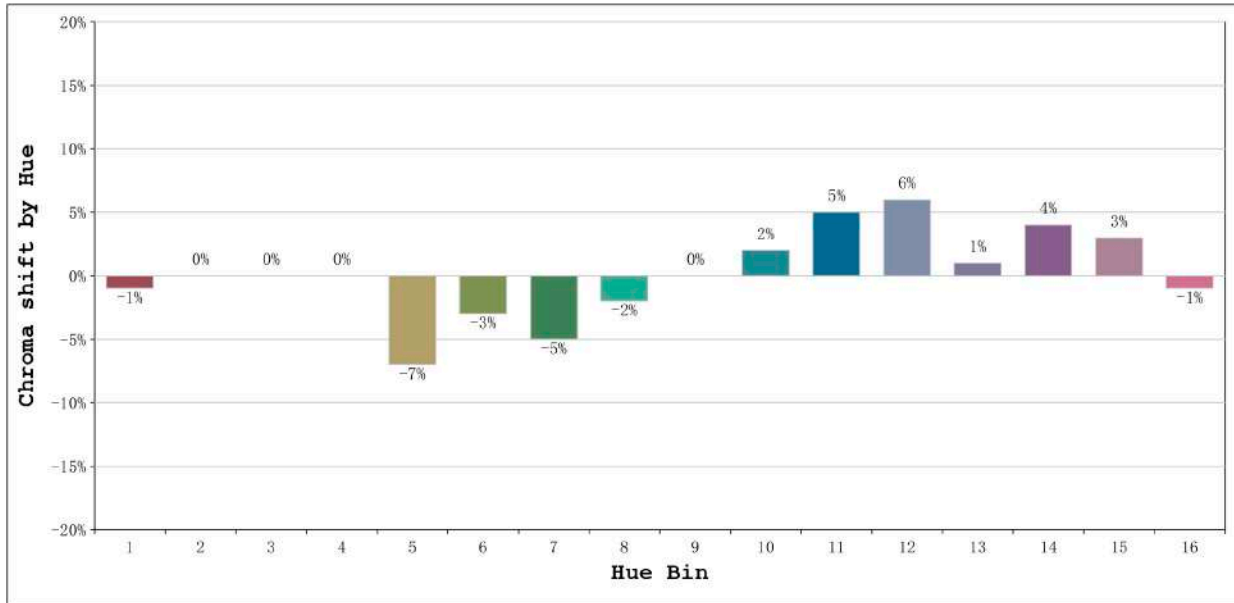

Hue Bin	Hue Angle	Rf	Graphic shift (%)	
			Chroma	Hue
1	0.0° - 22.5°	89	-1	3
2	22.5° - 45.0°	91	0	2
3	45.0° - 67.5°	94	0	1
4	67.5° - 90.0°	95	0	1
5	90.0° - 112.5°	85	-7	-1
6	112.5° - 135.0°	93	-3	0
7	135.0° - 157.5°	87	-5	4
8	157.5° - 180.0°	85	-2	7
9	180.0° - 202.5°	82	0	11
10	202.5° - 225.0°	76	2	15
11	225.0° - 247.5°	79	5	11
12	247.5° - 270.0°	89	6	2
13	270.0° - 292.5°	93	1	-3
14	292.5° - 315.0°	90	4	-2
15	315.0° - 337.5°	84	3	-4
16	337.5° - 360.0°	91	-1	0

Model:Ecoled Creta (CW)  
 Tester:Sergio Carneros  
 Temperature:25Deg  
 Manufacturer:Luz Negra.S.L

Number: 31.150  
 Date:2022-06-01 13:50:24  
 Humidity:57%  
 Remarks:100cm Tira flexible

**Spectrum Test Report**

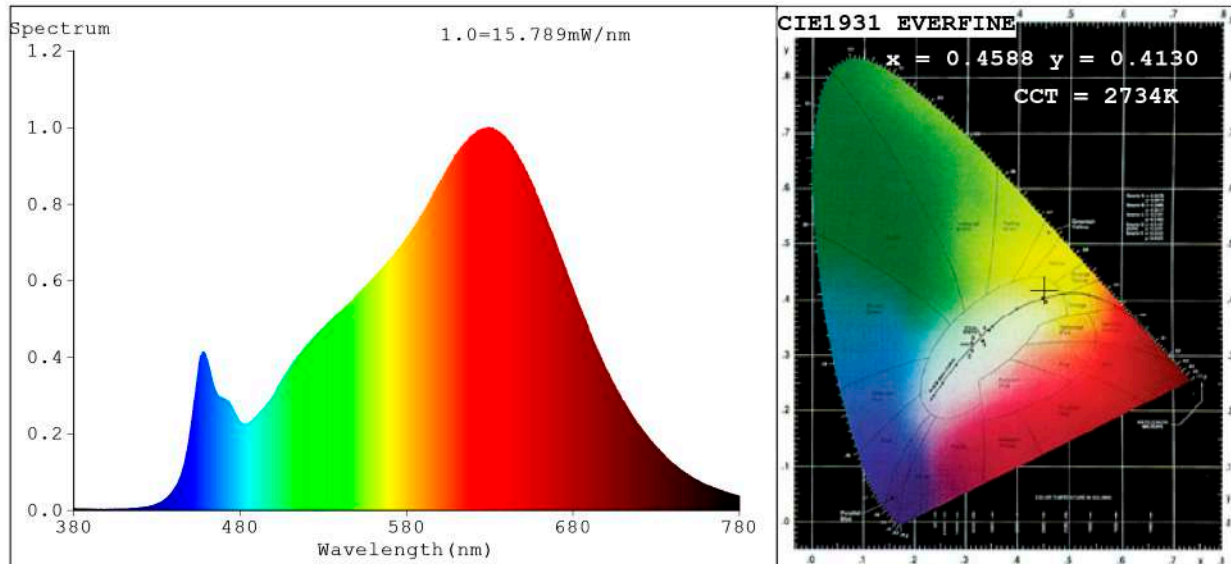

**Color Parameters:**

Chromaticity Coordinate: $x=0.4588$   $y=0.4130$ / $u'=0.2607$   $v'=0.5281$   
 CCT=2734K(Duv=0.0010) Dominant WL:Ld =583.7nm Purity=61.7%  
 Ratio:R=26.4% G=70.8% B=2.7%;;Peak WL:Lp=629.6nm FWHM=151.5nm  
 Render Index:Ra=95.1 CRI=93.0 TM30:Rf=90 Rg=97 Lav=610.5nm  
 R1 =96 R2 =99 R3 =100 R4 =94 R5 =95 R6 =98 R7 =93  
 R8 =86 R9 =72 R10=96 R11=96 R12=82 R13=97 R14=99 R15=92

**Photo Parameters:**

Flux = 713.8 lm Eff. : 86.44 lm/W Fe = 2.597 W Scotopic:947.14 S/P:1.3268

**Electrical parameters:**

V = 11.998 V I = 0.6883 A P = 8.258 W PF = 1.000

Status: Integral T = 1775 ms Ip = 52337 (80%)

Model:Ecoled Creta (WW)  
 Tester:Sergio Carneros  
 Temperature:25Deg  
 Manufacturer:Luz Negra.S.L

Number: 31.150  
 Date:2022-06-01 13:51:39  
 Humidity:57%  
 Remarks:100cm Tira flexible

Rf: 90      CCT: 2734 K      u': 0.2607  
Rg: 97      Duv: 0.0010      v': 0.5281

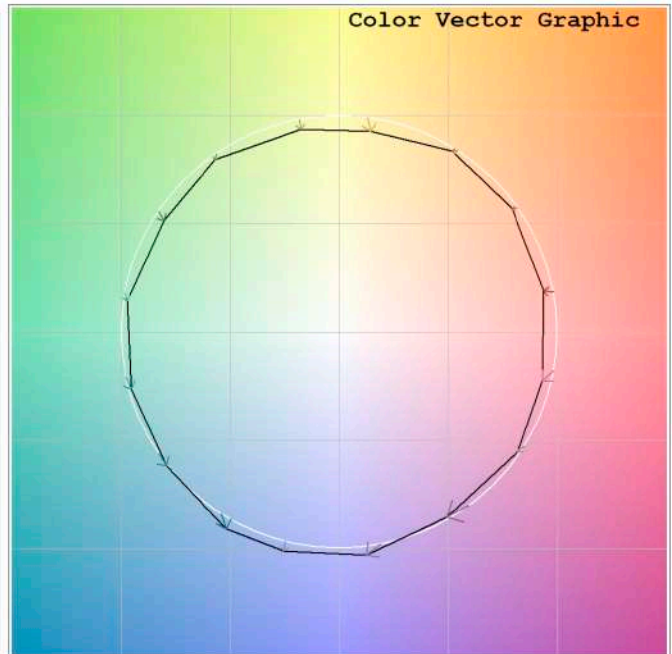
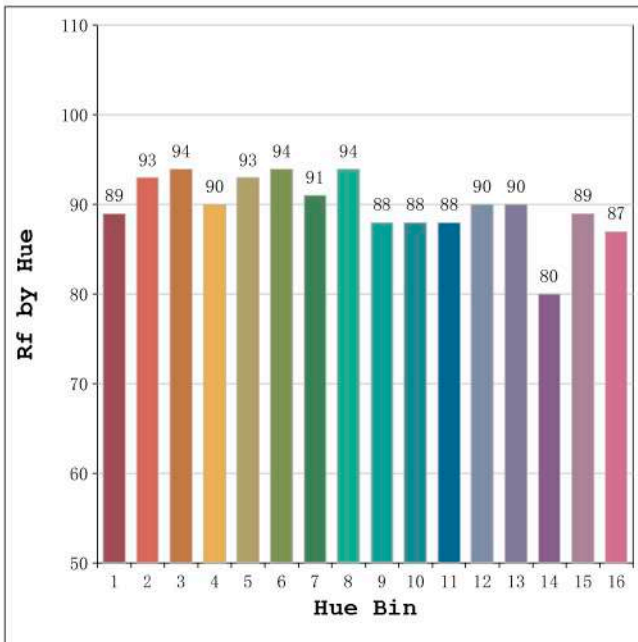
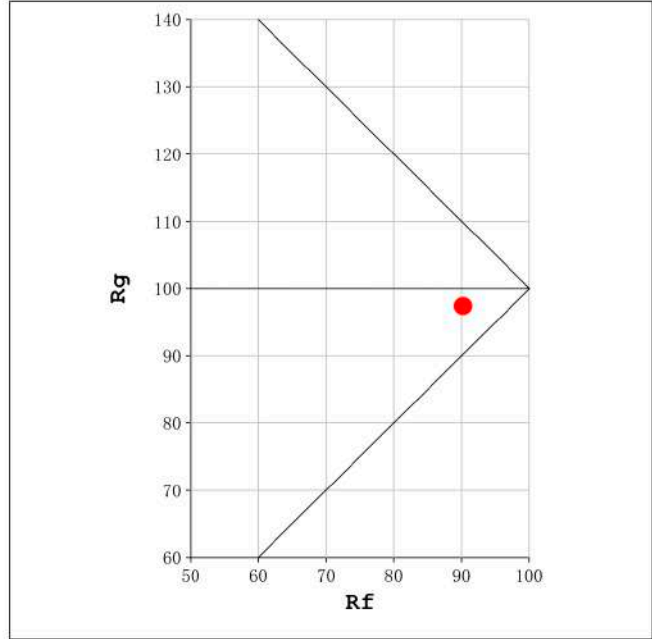
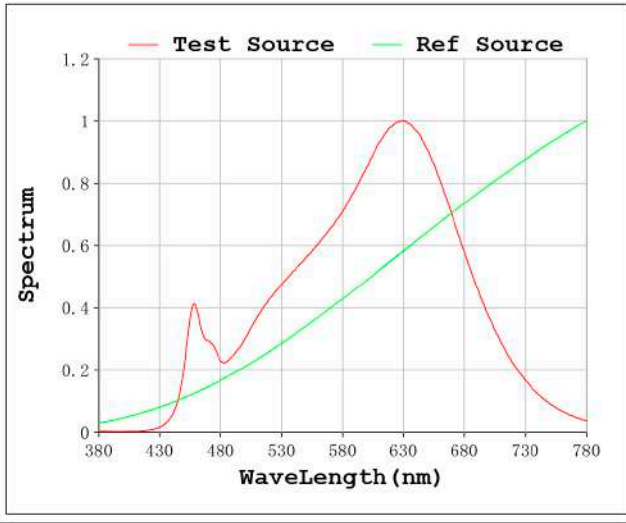

Model:Ecoled Creta (WW)  
Tester:Sergio Carneros  
Temperature:25Deg  
Manufacturer:Luz Negra.S.L

Number: 31.150  
Date:2022-06-01 13:51:39  
Humidity:57%  
Remarks:100cm Tira flexible



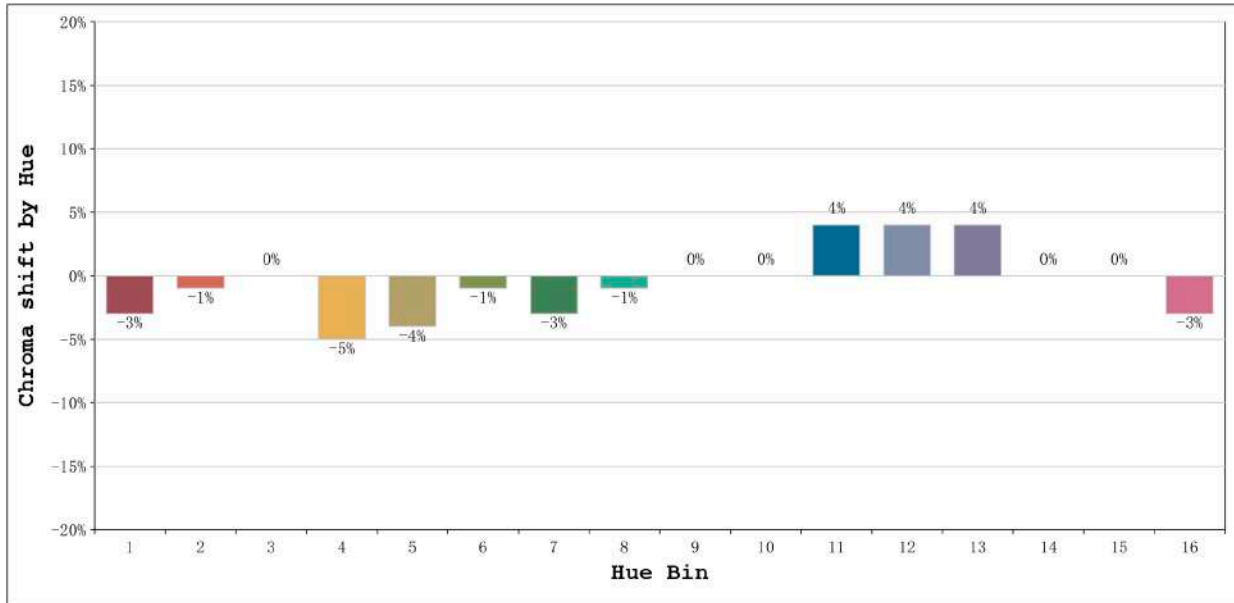

Hue Bin	Hue Angle	Rf	Graphic shift (%)	
			Chroma	Hue
1	0.0° - 22.5°	89	-3	2
2	22.5° - 45.0°	93	-1	2
3	45.0° - 67.5°	94	0	2
4	67.5° - 90.0°	90	-5	-2
5	90.0° - 112.5°	93	-4	0
6	112.5° - 135.0°	94	-1	2
7	135.0° - 157.5°	91	-3	2
8	157.5° - 180.0°	94	-1	3
9	180.0° - 202.5°	88	0	6
10	202.5° - 225.0°	88	0	7
11	225.0° - 247.5°	88	4	6
12	247.5° - 270.0°	90	4	0
13	270.0° - 292.5°	90	4	-7
14	292.5° - 315.0°	80	0	-10
15	315.0° - 337.5°	89	0	-3
16	337.5° - 360.0°	87	-3	-5

Model:Ecoled Creta (WW)  
 Tester:Sergio Carneros  
 Temperature:25Deg  
 Manufacturer:Luz Negra.S.L

Number: 31.150  
 Date:2022-06-01 13:51:39  
 Humidity:57%  
 Remarks:100cm Tira flexible