

# led profile by Luz Negra

## Paco

Our PROFESSIONAL led profile series for surface/hanging applications is manufactured in high purity aluminium, with 8 different colours to choose from.

The profile has an elegant hexagonal shape which can be rotated to achieve the desired lighting effect. Its inner tray (where we can find the led and power supply) can be removed from the front which means easy maintenance.

This profile can be combined with microprism covers both in transparent and frosted ("easy-ON" system), which improve glare and UGR levels. Both profile and covers are available in lengths of 6m, allowing us to carry out long installations without joints.

**We offer a 10 year guarantee on the profiles and 4 year guarantee on the covers.**

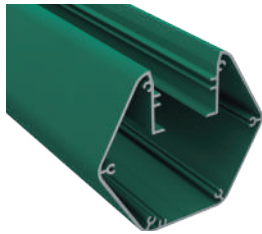
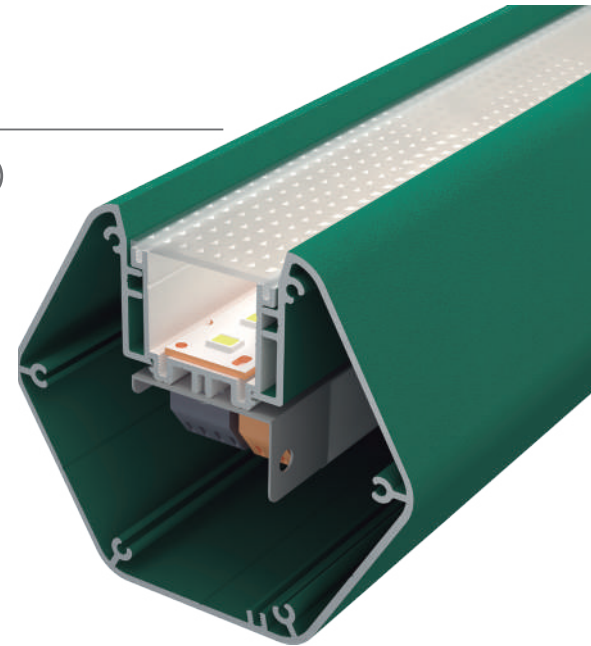

### Aluminium profile

17.036	azure blue lacquered (ral 5009)	6m
17.037	white lacquered (ral 9003)	6m
17.038	black lacquered (ral 9005)	6m
17.039	patina green lacquered (ral 6000))	6m
17.040	stone grey lacquered (ral 7030)	6m
17.041	pastel yellow lacquered (ral 1034)	6m
17.042	tomato red lacquered (ral 3013)	6m
17.043	ivory lacquered (ral 1014)	6m



### Aluminium endcaps

19.404	azure blue lacquered (ral 5009)	
19.405	white lacquered (ral 9003)	
19.406	black lacquered (ral 9005)	
19.407	patina green lacquered (ral 6000))	
19.408	stone grey lacquered (ral 7030)	
19.409	pastel yellow lacquered (ral 1034)	
19.410	tomato red lacquered (ral 3013)	
19.411	ivory lacquered (ral 1014)	



### "easy-ON" polycarbonate cover

18.070	frosted	6m
18.071	transparent microprism	6m
18.072	frosted microprism	6m
18.073	Black&White	6m



### Hanging kit

21.001	chrome	set of 2 units
21.002	white	set of 2 units
21.003	black	set of 2 units



### Aluminium tray

15.007	lacquered white	6m
--------	-----------------	----



### Safety cable

22.039	steel	18cm
--------	-------	------

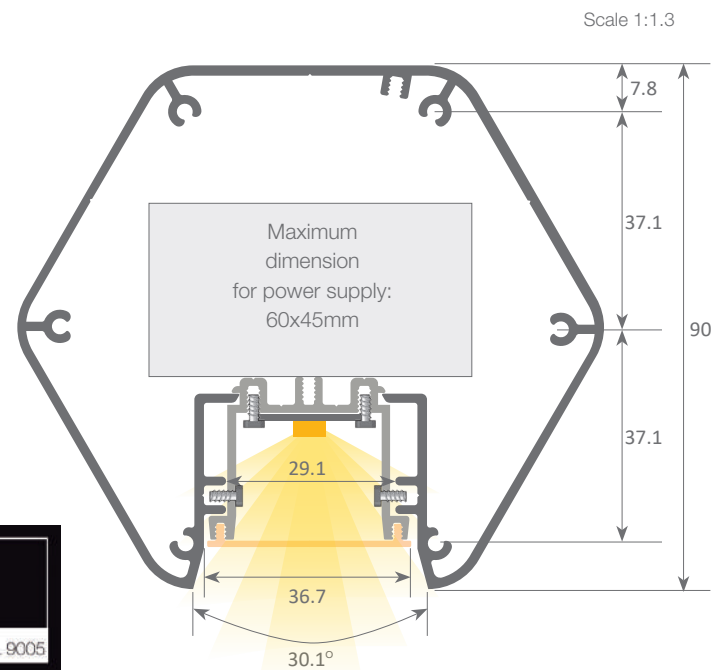

### Ral colours

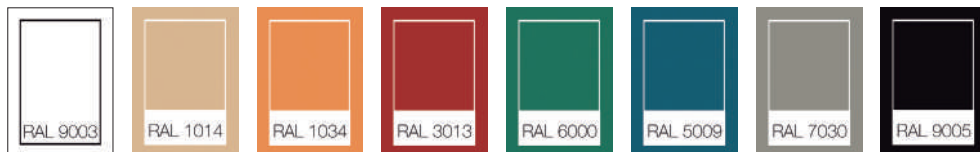

Aluminium alloy extrusion process in accordance with: ISO 9001:2015 / Tolerances: UNE-EN 755-9 / Theoretical weight: 2.101 kg / Alloy: 6063 / Perimeter: 885 mm / Anodisation minimum: 10 micras / Purity aluminium: 98.5% / Treatment: T-5



Surfaces

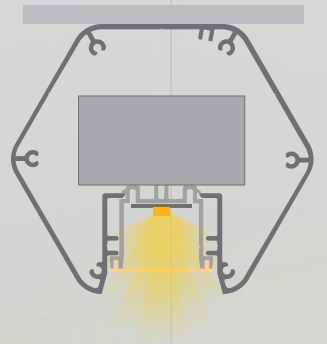

Hanging



Different positions

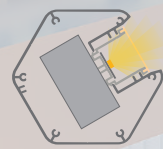

60°

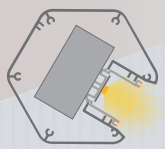

120°

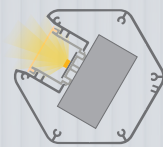

240°

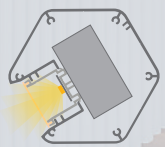

300°