

Neon Cairo RGB

Features:

- Silky, soft-touch silicone neon, with opaline front and integrated light source.
- Great for lighting up cornices and for creating decorative perimeter lighting, large letters and advertising texts, etc...
- Degree of protection: IP67
- Uses high quality silica gel and is resistant to yellowing, UV rays, saltpeper, high temperatures and is also flame retardant.
- Neon with frontal light emission.

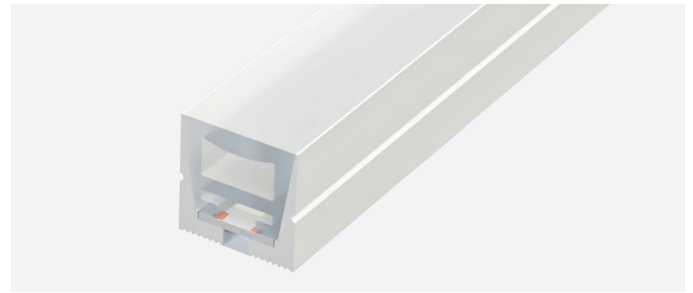

Reference	Colour temp.	Lumens/m	Lumens/W
10.243	RGB	314	25

Technical characteristics

Technical data

Power (per metre)	12W/m
Power (full 5m roll)	60W
Voltage	24V
Degree of protection	IP67

Led information

Number of leds per metre	120
--------------------------	-----

Temperatures and operating conditions

Working tempetarure	-40°C / +55°C
Storage temperature	-40°C / +60°C

Photometric data

Opening angle	110°
---------------	------

Aspects

Dimmable	Yes ^{*1}
Installation	Surface / Recessed
Apt for	Indoor / Outdoor

^{*1} Adjustable with appropriate controllers.

Useful lifespan

Estimated lifespan	30.000h ^{*2}
Daily recommended use	18h

^{*2} Depending on the dissipation of the profile, the daily working hours and the external environmental working temperature.



Neon Cairo RGB

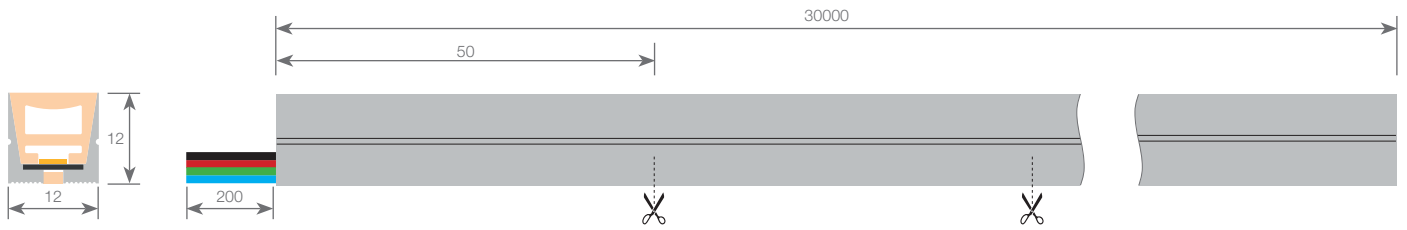

Dimensions and weight

Length	30000mm	Cutting section length	50mm
Width	12mm	Cable length	200mm
Height	12mm	Cable section	4x0,5mm ²

Connection

Maximum connection in open circuit	10m	Maximum connection in closed circuit	20m
------------------------------------	-----	--------------------------------------	-----

Photometric curves

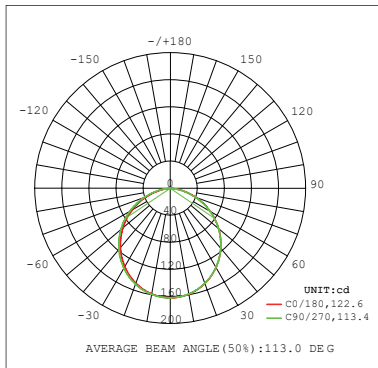

Curve diameter

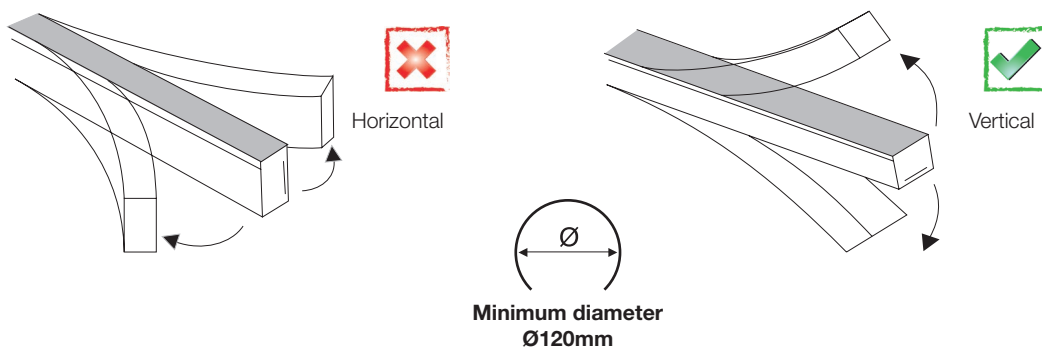

Neon Cairo RGB

Fixing

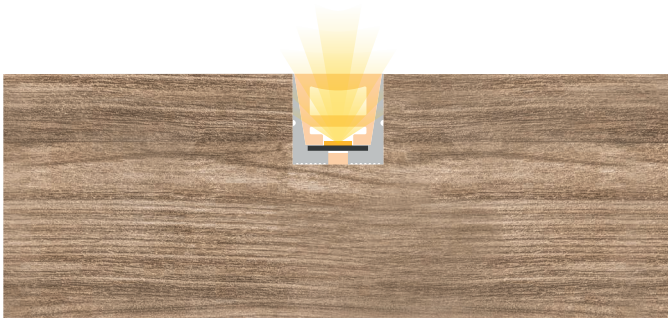

Compatible accessories



Clip profile
 10.254 1m white aluminium



Die-cut profile
 10.253 1m steel

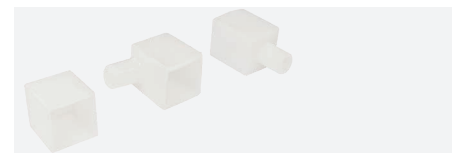

Silicone endcaps
 19.491 frosted
 19.490 frosted with side cable hole
 19.489 frosted with front cable hole



Aluminium clip
 20.083 white



Silicone for waterproofing
 22.138 45ml opal
 22.140 45ml transparent

Neon Cairo RGB

Assembly instructions with clip profile or clip

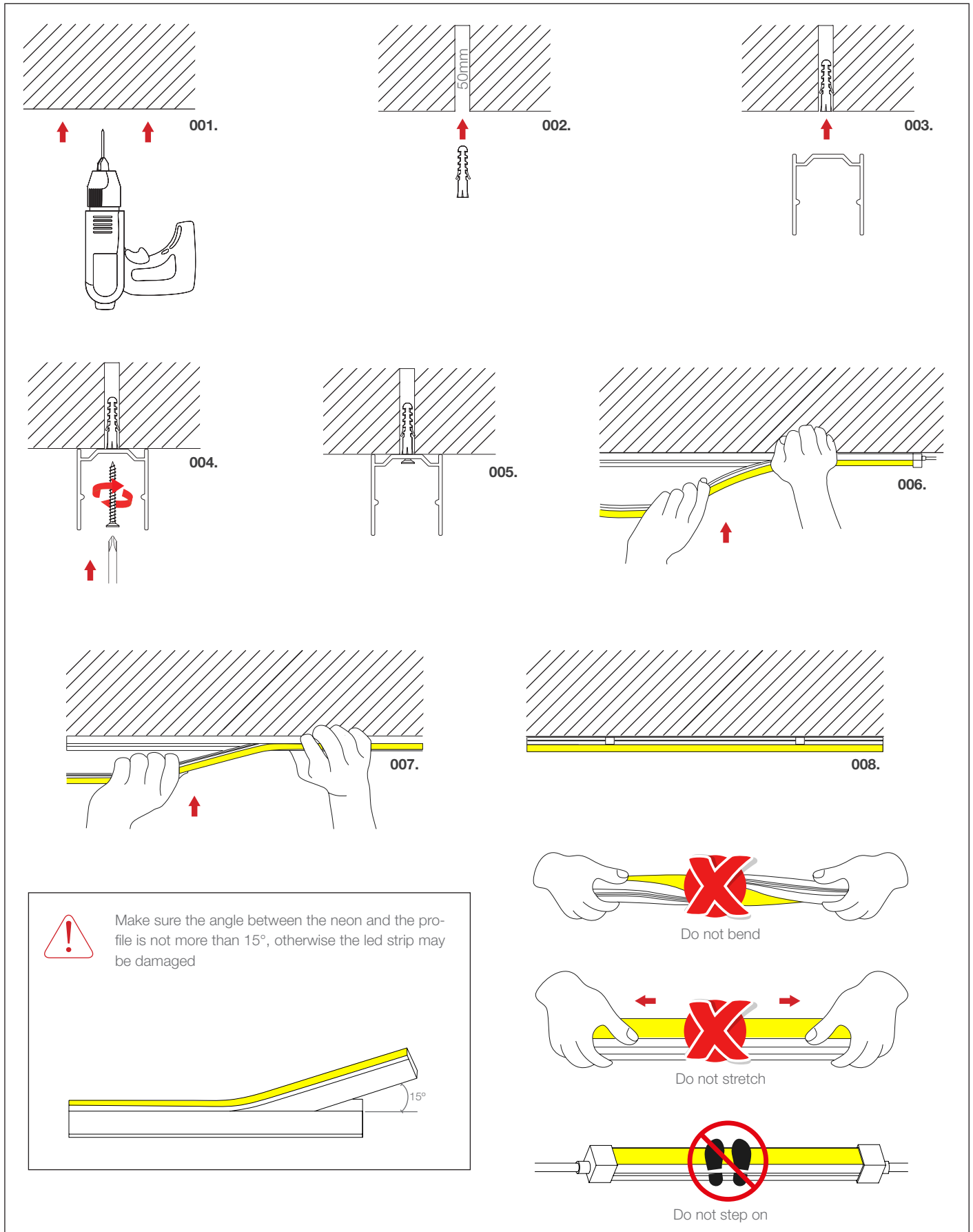

001. Drilling two holes into the wall.
 002. Drilling a 50mm hole into the wall.
 003. Inserting the clip into the wall hole.
 004. Tightening the clip with a screw.
 005. The clip is fully secured to the wall.
 006. Inserting the LED strip into the clip.
 007. Pushing the LED strip into the clip.
 008. The LED strip is fully installed in the clip.

 Make sure the angle between the neon and the profile is not more than 15°, otherwise the led strip may be damaged

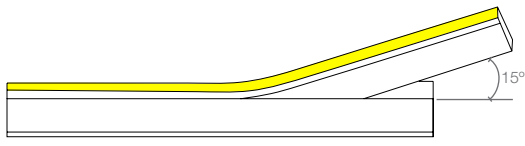

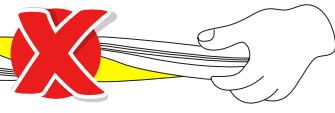
 Do not bend

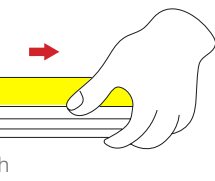
 Do not stretch

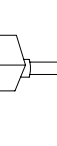
 Do not step on