

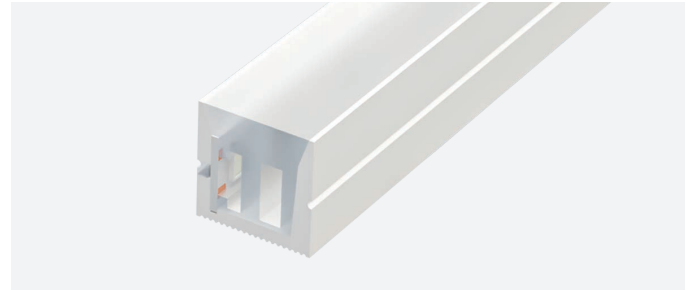



# Neon Kenya

## Features:

- Silky, soft-touch silicone neon, with opaline front and integrated light source.
- Great for lighting up cornices and for creating decorative perimeter lighting, large letters and advertising texts, etc...
- Degree of protection: IP67
- Uses high quality silica gel and is resistant to yellowing, UV rays, saltpeper, high temperatures and is also flame retardant.
- Neon with side light emission.



Reference	Colour temp.	Lumens/m	Lumens/W	Energy efficiency
10.246	6000K	805	69	
10.245	4000K	724	61	
10.244	3000K	626	58	

## Technical characteristics

### Technical data

Power (per metre)	12W/m
Power (full 5m roll)	360W
Voltage	24V
Degree of protection	IP67

### Led information

Number of leds per metre	140
--------------------------	-----

### Temperatures and operating conditions

Working tempetarure	-40°C / +55°C
Storage temperature	-40°C / +60°C

### Photometric data

CRI	90
Opening angle	110°

### Aspects

Dimmable	Yes <sup>*1</sup>
Installation	Surface / Recessed
Apt for	Indoor / Outdoor

<sup>\*1</sup> Adjustable with appropriate controllers.

### Useful lifespan

Estimated lifespan	30.000h <sup>*2</sup>
Daily recommended use	18h

<sup>\*2</sup> Depending on the dissipation of the profile, the daily working hours and the external environmental working temperature.



# Neon Kenya

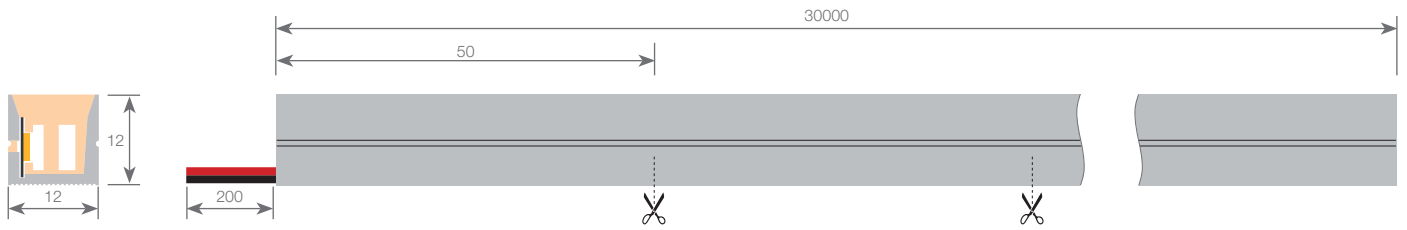

## Dimensions and weight

Length	30000mm	Cutting section length	50mm
Width	12mm	Cable length	200mm
Height	12mm	Cable section	2x0.5mm <sup>2</sup>

## Connection

Maximum connection in open circuit	6m	Maximum connection in closed circuit	12m
------------------------------------	----	--------------------------------------	-----

## Photometric curves

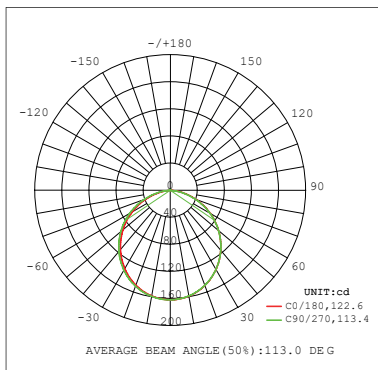

## Curve diameter

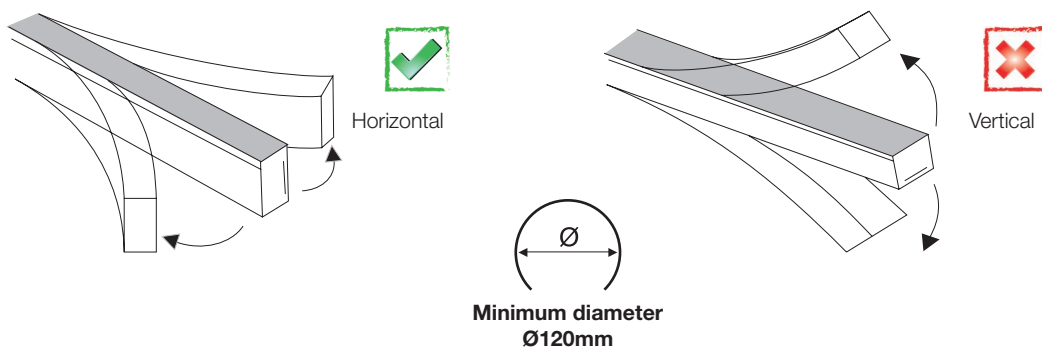

# Neon Kenya

## Fixing

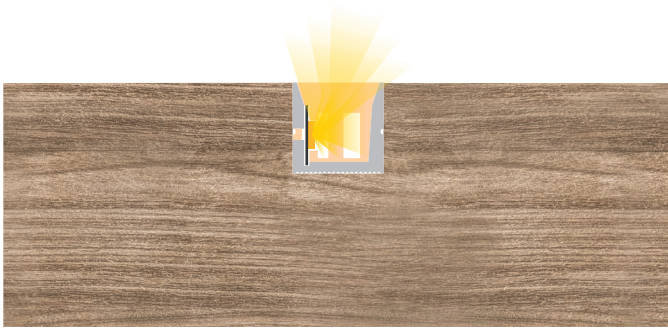

## Compatible accessories

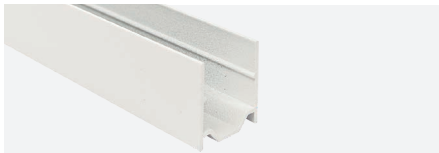

**Aluminium clip profile**  
 10.254 1m white



**Die-cut profile**  
 10.253 1m steel

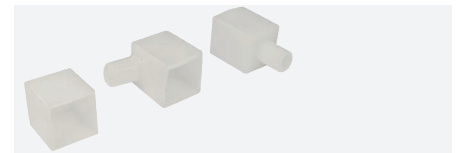

**Silicone endcaps**  
 19.491 frosted  
 19.490 frosted with side cable hole  
 19.489 frosted with front cable hole

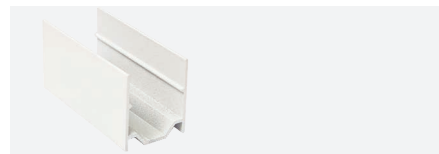

**Aluminium clip**  
 20.083 white



**Silicone for waterproofing**  
 22.138 45ml opal  
 22.140 45ml transparent

# Neon Kenya

## Assembly instructions with clip profile or clip

001. 002. 003.

004. 005. 006.

007. 008.

**!** Make sure the angle between the neon and the profile is not more than 15°, otherwise the led strip may be damaged

15°

Do not bend

Do not stretch

Do not step on