

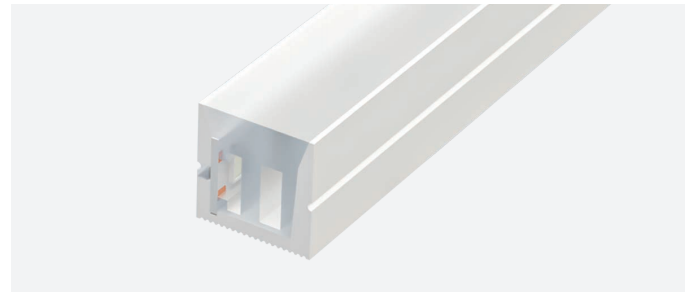



Neón Kenya

Características:

- Perfiles de silicona de tacto sedoso, con frontal opalino y fuente de luz integrada.
- Permite iluminar foseados, cornisas, realizar iluminación perimetral decorativa, letras y textos publicitarios de grandes dimensiones, etc...
- Grado de protección: IP67
- Utiliza gel de sílice gaseoso de alta calidad, resistente al amarilleamiento, a los rayos UV, al salitre, a altas temperaturas y son retardantes de llama.
- Neón con emisión de luz lateral.



Referencias	Temp. color	Lúmenes/m	Lúmenes/W	Eficiencia energética
10.269	6000K	805	69	
10.268	4000K	724	61	
10.267	3000K	626	58	

Características técnicas

Datos técnicos

Potencia (por metro)	12W/m
Voltaje	24V
Grado de protección	IP67

Información de led

Número de leds por metro	140
--------------------------	-----

Temperaturas y condiciones de funcionamiento

Temperatura de trabajo *1	-40°C / +55°C
Temperatura almacenamiento	-40°C / +60°C

Datos fotométricos

IRC	90
Ángulo de apertura	110°

Prestaciones

Regulable	Si *1
Modo de instalación	Superficie / Encastre
Apto para	Interior / Exterior

*1 Regulable con los controladores adecuados.

Vida media

Vida útil estimada	30.000h *2
Uso máximo ininterrumpido	18h

*2 En función de la disipación del perfil, de las horas diarias trabajadas y de la temperatura externa ambiental de trabajo.



Neón Kenya

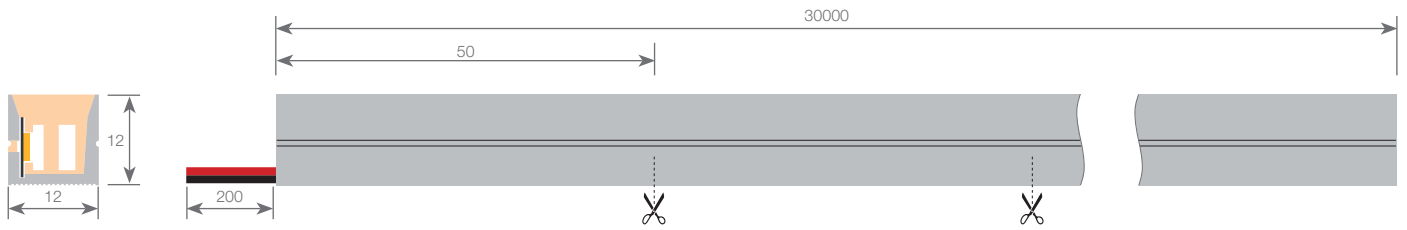

Dimensiones

Largo	30000mm	Longitud sección de corte	50mm
Ancho	12mm	Longitud del cable	200mm
Alto	12mm	Sección del cable	2x0,5mm ²

Conexionado

Máxima conexión en circuito abierto	6m	Máxima conexión en circuito cerrado	12m
-------------------------------------	----	-------------------------------------	-----

Curvas fotométricas

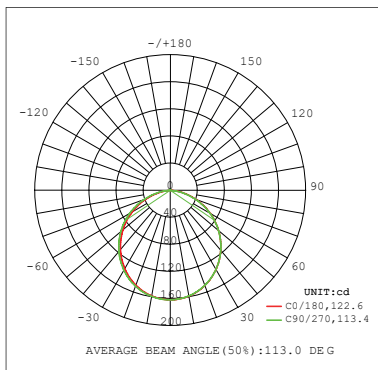

Diámetro de curvatura

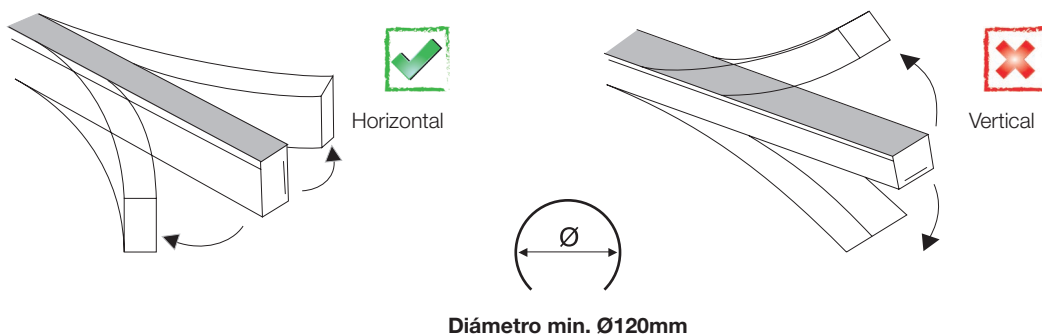

Neón Kenya

Fijación

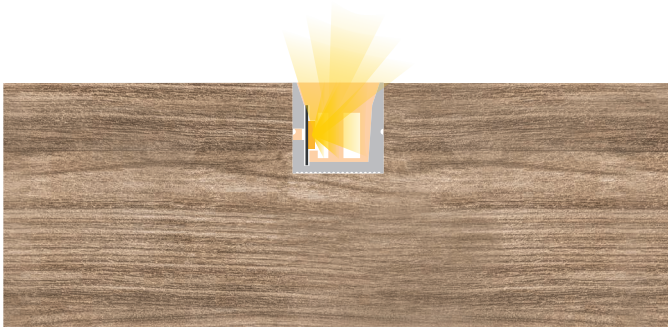

Accesorios compatibles



Perfil grapa de aluminio
10.254 1m blanco



Perfil troquelado
10.253 1m acero

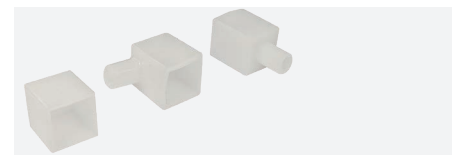

Tapas de silicona
19.491 glaseado
19.490 glaseado con agujero pasacable lateral
19.489 glaseado con agujero pasacable frontal



Grapa de aluminio
20.083 blanco





Silicona para estancar
22.138 45ml opal
22.140 45ml transparente

Neón Kenya

Instrucciones de montaje con perfil grapa o grapa

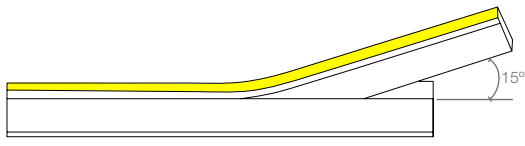

 Asegúrese de que el ángulo entre la luz y el perfil no es superior a 15°, de lo contrario podría dañarse la tira de led.



No doblar

No estirar

No pisar