

# Tira flexible COB 8mm / COB 8mm flexible LED strip / Ruban flexible COB 8mm

## Características / Features / Caractéristiques:

- Diseño COB. / COB design. / Type COB.
- Permiten iluminar de forma lineal sin que se aprecien los puntos led. / They allow linear illumination without the led spots being visible. / Elles permettent un éclairage linéaire sans que les points led soient visibles.
- Proporciona un efecto luminoso continuo y uniforme. / Provides a continuous and uniform light effect. / Fournit un effet lumineux continu et uniforme.
- Incorpora en la parte trasera del PCB una lámina de acero que ayuda en la disipación térmica. / Our COB led strips have a small iron strip incorporated at the back of the PCB which improves heat dissipation. / Incorporée à l'arrière du PCB qui améliore la dissipation de la chaleur.
- Aporta una resistencia de torsión un 80%. / Its strong point is that it offers 80% more in torsional resistance. / Il offre une résistance à la torsion de 80%.



Referencia / Reference / Référence	Temp. color / Colour temp. / Temp. de couleur	Flujo lumínico (lm/m) / Luminous flux (lm/m) / Flux lumineux (lm/m)	Eficiencia lumínica (lm/W) / Light efficiency (lm/W) / Rendement lumineux (lm/W)	Eficiencia energética / Energy efficiency / Rendement énergétique
31.148	6000K	1186	108	<b>F</b>

## Características técnicas / Technical characteristics / Caractéristiques techniques

### Datos técnicos / Technical data / Données techniques

Potencia (x metro) / Power (x metre) / Puissance (par mètre)	11W/m
Potencia del rollo (5m) / Power of the roll (5m) / Puissance du rouleau (5m)	55W
Voltaje / Voltage	12V
Grado de protección / Degree of protection / Degré de protection	IP20

### Información de LED / LED information / Informations du LED

Tipo de LED / Type of LED / Type de LED	COB
Nº de LEDs por metro / No. of LEDs per metre / N° de LED par mètre	400
Nº de LEDs por sección / No. of LEDs per section / N° de LED par section	4

### Temperaturas / Temperatures / Températures

Temperatura de trabajo / Working temperature / Température de travail *1	-25°C / +40°C
Temperatura almacenamiento / Storage temperature / Température de stockage	-40°C / +80°C

\*1 Ver instrucciones de montaje / See assembly instructions / Voir instructions de montage

### Datos fotométricos / Photometric data / Données photométriques

IRC / CRI	>85
Ángulo de apertura / Opening angle / Angle d'ouverture	180°

### Prestaciones / Features / Prestations

Regulable / Dimmable / Réglable	Sí / Yes / Oui *2
Autoadhesivo / Self-adhesive / Bande adhésive	Cinta térmica 3M / 3M heat tape / Bande thermique 3M
Apto para / Apt for / Convient pour	Interior / Indoor / Intérieur

\*2 Regulable con los controladores adecuados. / Adjustable with appropriate controllers. / Réglable avec les contrôleurs appropriés.

### Vida media / Useful lifespan / Durée de vie

Vida útil estimada / Estimated lifespan / Durée de vie estimée	50.000h
Uso máximo ininterrumpido / Daily recommended use / Usage maximum sans interruption	18h



# Tira flexible COB 8mm / COB 8mm flexible LED strip / Ruban flexible COB 8mm

Escala 1:1 / Scale 1:1 / Échelle 1:1

Dimensiones en mm / Dimensions in mm / Dimensions en mm

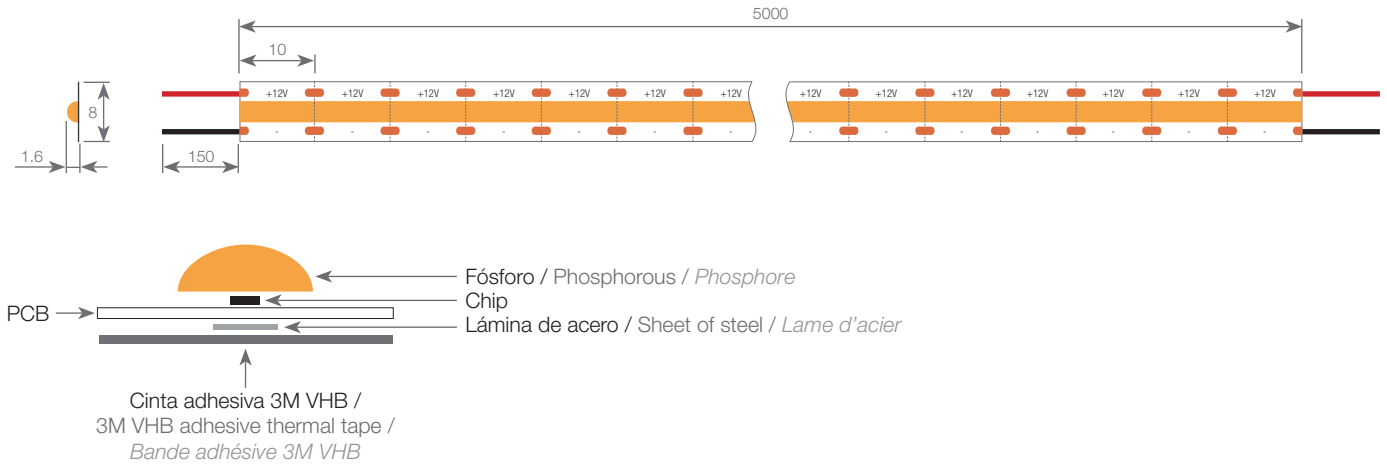

## Dimensiones / Dimensions / Dimensions

Largo / Length / Longueur du rouleau	5000mm	Longitud sección de corte / Cutting section length / Longueur de la section sécable	10mm
Ancho / Width / Largeur	8mm	Longitud del cable / Cable length / Longueur du câble	150mm
Alto / Height / Hauteur	1.6mm	Sección del cable / Cable section / Section du câble	2x0.5mm <sup>2</sup>

## Conexión / Connection / Connexion

Máxima conexión en circuito abierto / Maximum connection in open circuit / Connexion max. en circuit ouvert	3m	Máxima conexión en circuito cerrado / Maximum connection in closed circuit / Connexion max. en circuit fermé	6m
---	----	--	----

## Curvas fotométricas / Photometric curves / Courbes photométriques

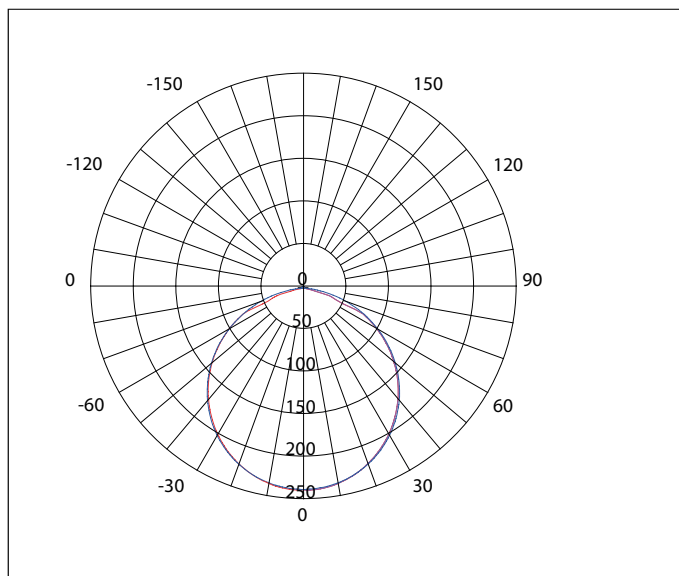

# Tira flexible COB 8mm / COB 8mm flexible LED strip / Ruban flexible COB 8mm

## Instrucciones de montaje / Assembly instructions / Instructions de montage

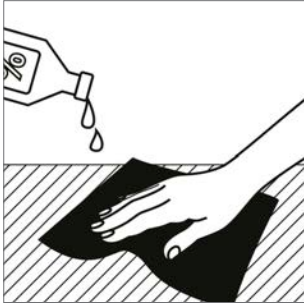

1.  
Limpiar la superficie de instalación.  
Clean the installation surface.  
*Nettoyer la surface d'installation.*

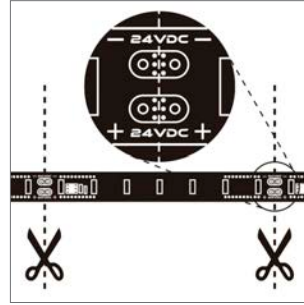

2.  
Cortar por las líneas indicadas.  
Cut along the indicated lines.  
*Couper le long des lignes pointillées.*

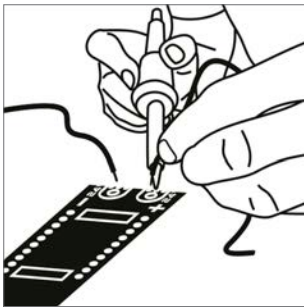

3.  
La polaridad (+/-) debe respetarse. La temperatura de soldadura no puede exceder a 360°C.  
The polarity (+/-) must be respected. The soldering temperature must not exceed 360°C.  
*La polarité (+/-) doit être respectée. La température de soudure ne doit pas dépasser 360°C.*

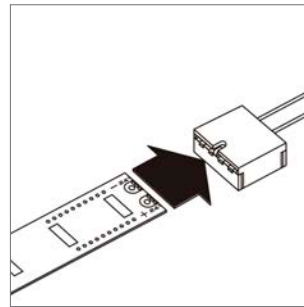

4.  
Consultar nuestros conectores disponibles en IP20 - IP65.  
Check out our connectors available in IP20 - IP65.  
*Consulter nos connecteurs disponibles en IP20 - IP65.*

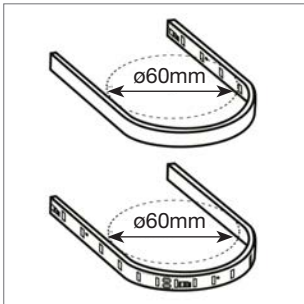

5.  
Diámetro de curvatura mínimo.  
Minimum bending diameter.  
*Diamètre minimum de courbure.*

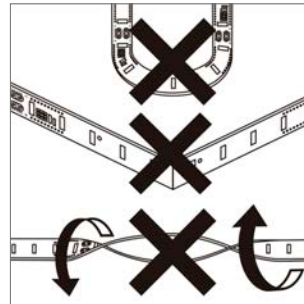

6.  
Las tiras flexibles no deben retorcerse ni doblarse con ángulos cerrados.  
The flexible strips must not be twisted or bent at sharp angles.  
*Les bandes flexibles ne doivent pas être tordues ou pliées à angle vif.*

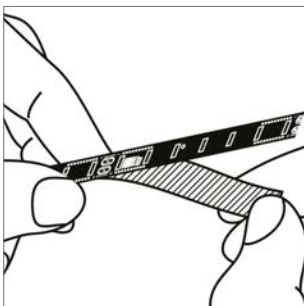

7.  
Aplicar eliminando el protector de la cinta trasera.  
Fix by removing the back tape protector.  
*Appliquer en retirant le protecteur adhésif du dos.*

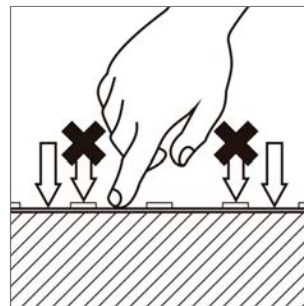

8.  
A la hora de aplicar la tira, presionar entre los LEDs y nunca en la superficie del LED.  
When applying the strip, press between the leds and not on the surface of the LED.  
*Lors de l'application de la bande, appuyer entre les diodes et non pas sur la surface du LED.*

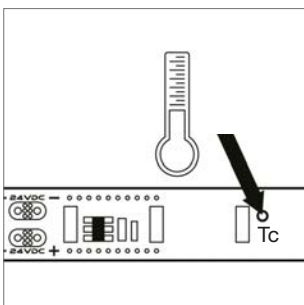

9.  
Se recomienda el uso de un perfil de aluminio para su disipación térmica. \*1  
The use of an aluminium profile is recommended for heat dissipation. \*1  
*Il est recommandé l'utilisation d'un profilé en aluminium pour la dissipation thermique. \*1*

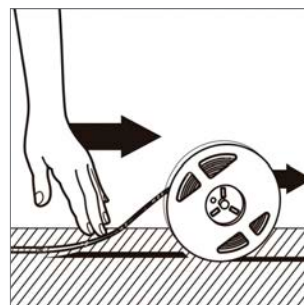

10.  
Manipular la tira flexible apagada y desenrolle según se vaya aplicando.  
Only handle the flexible strip when off. Unwind and gradually put in place.  
*Manipuler la bande flexible et la dérouler au fur et à mesure de l'application.*